



## **PLA Series**

### **Application Module**

## **Product Manual**

**Version 5.12 Software**

**Manual HG501763**

### **IMPORTANT**

The PL/A product is a very powerful device and may be programmed to handle very complex applications (e.g., tension loops, open loop winders, and closed loop winders) using the Application Blocks Menu. Features of this menu are described in a supplement to this manual titled *PLX Technical Manual Addendum - Application Software* (Bardac Manual HG501442).

Please read and fully understand the procedures of this manual before installing or commissioning your module. If in doubt about any sections of this manual, before proceeding, please call Bardac Drives for assistance at:

**410-604-3400**

---

# **Bardac** **drives**



NOTE. These instructions do not purport to cover all details or variations in equipment, or to provide for every possible contingency to be met in connection with installation, operation, or maintenance. Should further information be desired or should particular problems arise which are not covered sufficiently for the purchaser's purposes, the matter should be referred to the local Supplier sales office. The contents of this instruction manual shall not become part of or modify any prior or existing agreement, commitment, or relationship. The sales contract contains the entire obligation of Bardac Corporation. The warranty contained in the contract between the parties is the sole warranty of Bardac Corporation. Any statements contained herein do not create new warranties or modify the existing warranty.

## **IMPORTANT MESSAGE**

**This is a version 5.12 PLA product manual. Units with software version 5.12 upwards contain all the functions described.**

**This manual describes the PLA unit (Programmable logic arithmetic). The PLA functionality is similar to the PL/X Digital DC Drive . Use this manual in conjunction with the PL/X Digital DC Drive product manuals.**

The application blocks are normally dormant and may be activated by using the GOTO function. Please refer to section **13 CONFIGURATION** in the PL/X Digital DC Drive product manual.

The application blocks consist of various inputs, processing functions and outputs that are found to be useful in typical industrial motion control and process industries.

## **1 Table of contents and Introduction**

1	Table of contents and Introduction .....	3
1.1	Introduction .....	6
1.2	General Warnings .....	7
1.3	Warnings and Instructions .....	8
1.4	General Risks .....	9
1.5	PLA dimensions.....	10
2	Terminals .....	11
2.1	Control terminals 1 to 36.....	11
2.1.1	Control terminals on lower board numbers 41 - 52.....	12
2.1.2	Remote RA+ (T41) and RA- (T43).....	12
2.1.3	Common Mode Range.....	12
2.1.4	High voltage AC (T45, T47).....	13
2.1.5	Analogue input ACT. (ACT T50, 0Volts T49) .....	13
2.1.6	Control terminals on lower board numbers 53 - 64.....	13
3	APPLICATION BLOCKS .....	15
3.1	General rules.....	15
3.1.1	Sample times .....	15
3.1.2	Order of processing .....	16
3.1.3	Logic levels .....	16
3.1.4	Activating blocks.....	16
3.1.5	CONFLICT HELP MENU .....	16
3.2	APPLICATION BLOCKS / SUMMER 1, 2 .....	18
3.2.1	SUMMER 1, 2 / Block diagram .....	19
3.2.2	SUMMER 1, 2 / Total output monitor PIN 401 / 415 .....	19
3.2.3	SUMMER 1, 2 / Sign 1 PIN 402 / 416.....	19
3.2.4	SUMMER 1, 2 / Sign 2 PIN 403 / 417.....	20
3.2.5	SUMMER 1, 2 / Ratio 1 PIN 404 / 418.....	20

3.2.6	SUMMER 1, 2 / Ratio 2	PIN 405 / 419	20
3.2.7	SUMMER 1, 2 / Divider 1	PIN 406 / 420	20
3.2.8	SUMMER 1, 2 / Divider 2	PIN 407 / 421	20
3.2.9	SUMMER 1, 2 / Input 1	PIN 408 / 422	21
3.2.10	SUMMER 1, 2 / Input 2	PIN 409 / 423	21
3.2.11	SUMMER 1, 2 / Input 3	PIN 410 / 424	21
3.2.12	SUMMER 1, 2 / Deadband	PIN 411 / 425	21
3.2.13	SUMMER 1, 2 / Output sign inverter	PIN 412 / 426	21
3.2.14	SUMMER 1, 2 / Symmetrical clamp	PIN 413 / 427	22
<b>3.3</b>	<b>APPLICATION BLOCKS / PID 1, 2</b>		<b>23</b>
3.3.1	PID 1, 2 / Block diagram		24
3.3.2	PID 1, 2 / PID output monitor	PIN 429 / 452	25
3.3.3	PID 1, 2 / PID IP1 value	PIN 430 / 453	25
3.3.4	PID 1, 2 / PID IP1 ratio	PIN 431 / 454	25
3.3.5	PID 1, 2 / PID IP1 divider	PIN 432 / 455	25
3.3.6	PID 1, 2 / PID IP2 value	PIN 433 / 456	25
3.3.7	PID 1, 2 / PID IP2 ratio	PIN 434 / 457	26
3.3.8	PID 1, 2 / PID IP2 divider	PIN 435 / 458	26
3.3.9	PID 1, 2 / PID proportional gain	PIN 436 / 459	26
3.3.10	PID 1, 2 / PID integrator time constant	PIN 437 / 460	26
3.3.11	PID 1, 2 / PID derivative time constant	PIN 438 / 461	27
3.3.12	PID 1, 2 / PID derivative filter time constant	PIN 439 / 462	27
3.3.13	PID 1, 2 / PID integrator preset	PIN 440 / 463	27
3.3.14	PID 1, 2 / PID integrator preset value	PIN 441 / 464	27
3.3.15	PID 1, 2 / PID reset	PIN 442 / 465	28
3.3.16	PID 1, 2 / PID positive clamp level	PIN 443 / 466	28
3.3.17	PID 1, 2 / PID negative clamp level	PIN 444 / 467	28
3.3.18	PID 1, 2 / PID output % trim	PIN 445 / 468	28
3.3.19	PID 1, 2 / PID profile mode select	PIN 446 / 469	29
3.3.20	PID 1, 2 / PID minimum proportional gain	PIN 447 / 470	29
3.3.21	PID 1, 2 / PID Profile X axis minimum	PIN 448 / 471	29
3.3.22	PID 1, 2 / PID Profile X axis GET FROM		30
3.3.23	PID 1, 2 / PID Profiled prop gain output monitor	PIN 449 / 472	30
3.3.24	PID 1, 2 / PID clamp flag monitor	PIN 450 / 473	30
3.3.25	PID 1, 2 / PID error value monitor	PIN 451 / 474	30
<b>3.4</b>	<b>APPLICATION BLOCKS / PARAMETER PROFILER</b>		<b>31</b>
3.4.1	PARAMETER PROFILER / Block diagram		31
3.4.1.1	Profile for Y increasing with X		31
3.4.1.2	Profile for Y decreasing with X		32
3.4.1.3	Examples of general profiles		32
3.4.2	PARAMETER PROFILER / Profile Y output monitor	PIN 475	33
3.4.3	PARAMETER PROFILER / Profiler mode	PIN 476	33
3.4.4	PARAMETER PROFILER / Profile Y at Xmin	PIN 477	33
3.4.5	PARAMETER PROFILER / Profile Y at Xmax	PIN 478	33
3.4.6	PARAMETER PROFILER / Profile X axis minimum	PIN 479	34
3.4.7	PARAMETER PROFILER / Profile X axis maximum	PIN 480	34
3.4.8	PARAMETER PROFILER / Profile X axis rectify	PIN 481	34
3.4.9	PARAMETER PROFILER / Profile X axis GET FROM		34
<b>3.5</b>	<b>APPLICATION BLOCKS / REEL DIAMETER CALC</b>		<b>35</b>
3.5.1	REEL DIAMETER CALC / Block diagram		36
3.5.2	REEL DIAMETER CALC / Diameter output monitor	PIN 483	36
3.5.3	REEL DIAMETER CALC / Web speed input	PIN 484	36
3.5.4	REEL DIAMETER CALC / Reel speed input	PIN 485	36
3.5.5	REEL DIAMETER CALC / Minimum diameter input	PIN 486	37
3.5.6	REEL DIAMETER CALC / Diameter calculation min speed	PIN 487	37
3.5.7	REEL DIAMETER CALC / Diameter hold enable	PIN 488	37
3.5.8	REEL DIAMETER CALC / Diameter filter time constant	PIN 489	37
3.5.9	REEL DIAMETER CALC / Diameter preset enable	PIN 490	38

3.5.10 REEL DIAMETER CALC / Diameter preset value PIN 491.....	38
3.5.11 REEL DIAMETER CALC / Diameter web break threshold PIN 492.....	38
3.5.12 REEL DIAMETER CALC / Diameter memory boot up PIN 493.....	38
<b>3.6 APPLICATION BLOCKS / TAPER TENSION CALC.....</b>	<b>39</b>
3.6.1 TAPER TENSION CALC / Block diagram.....	39
3.6.1.1 Linear taper equation.....	39
3.6.1.2 Hyperbolic taper equation.....	39
3.6.1.3 Taper graphs showing tension versus diameter.....	40
3.6.1.4 Taper graphs showing torque versus diameter.....	40
3.6.2 TAPER TENSION CALC / Total tension OP monitor PIN 494.....	40
3.6.3 TAPER TENSION CALC / Tension reference PIN 495.....	40
3.6.4 TAPER TENSION CALC / Taper strength input PIN 496.....	41
3.6.5 TAPER TENSION CALC / Hyperbolic taper enable PIN 497.....	41
3.6.6 TAPER TENSION CALC / Tension trim input PIN 498.....	41
3.6.7 TAPER TENSION CALC / Tapered tension monitor PIN 499.....	41
<b>3.7 APPLICATION BLOCKS / TORQUE COMPENSATOR.....</b>	<b>42</b>
3.7.1 TORQUE COMPENSATOR / Block diagram.....	43
3.7.2 TORQUE COMPENSATOR / Torque demand monitor PIN 500.....	44
3.7.3 TORQUE COMPENSATOR / Torque trim input PIN 501.....	44
3.7.4 TORQUE COMPENSATOR / Stiction compensation PIN 502.....	44
3.7.5 TORQUE COMPENSATOR / Stiction web speed threshold PIN 503.....	44
3.7.6 TORQUE COMPENSATOR / Static friction compensation PIN 504.....	45
3.7.7 TORQUE COMPENSATOR / Dynamic friction compensation PIN 505.....	45
3.7.8 TORQUE COMPENSATOR / Friction sign PIN 506.....	46
3.7.9 TORQUE COMPENSATOR / Fixed mass inertia PIN 507.....	46
3.7.10 TORQUE COMPENSATOR / Variable mass inertia PIN 508.....	46
3.7.11 TORQUE COMPENSATOR / Material width PIN 509.....	47
3.7.12 TORQUE COMPENSATOR / Accel line speed input PIN 510.....	47
3.7.13 TORQUE COMPENSATOR / Accel scaler PIN 511.....	48
3.7.14 TORQUE COMPENSATOR / Accel input/monitor PIN 512.....	48
3.7.15 TORQUE COMPENSATOR / Accel filter time constant PIN 513.....	48
3.7.16 TORQUE COMPENSATOR / Tension demand input PIN 514.....	48
3.7.17 TORQUE COMPENSATOR / Tension scaler PIN 515.....	49
3.7.18 TORQUE COMPENSATOR / Torque memory select PIN 516.....	49
3.7.19 TORQUE COMPENSATOR / Torque memory input PIN 517.....	49
3.7.20 TORQUE COMPENSATOR / Tension enable PIN 518.....	49
3.7.21 TORQUE COMPENSATOR / Overwind/underwind PIN 519.....	50
3.7.22 TORQUE COMPENSATOR / Inertia comp monitor PIN 520.....	50
<b>3.8 Centre winding block arrangement.....</b>	<b>51</b>
<b>3.9 APPLICATION BLOCKS / PRESET SPEED.....</b>	<b>52</b>
3.9.1 PRESET SPEED / Block diagram.....	53
3.9.2 PRESET SPEED / Preset speed output monitor PIN 523.....	54
3.9.3 PRESET SPEED / Select bit inputs 1 lsb, 2, 3 msb PINs 524 / 525 / 526.....	54
3.9.4 PRESET SPEED / OP value of 000 to 111 PINs 527 to 534.....	54
<b>3.10 APPLICATION BLOCKS / MULTI-FUNCTION 1 to 8.....</b>	<b>55</b>
3.10.1 MULTI-FUNCTION / Block diagram.....	55
3.10.2 MULTI-FUNCTION 1 to 8 / Function mode PINs 544/6/8, 550/2/4/6/8.....	56
3.10.2.1 Sample and hold function.....	56
3.10.3 MULTI-FUNCTION 1 to 8 / Output select 1 to 8 PIN 545/7/9, 551/3/5/7/9.....	56
3.10.4 MULTI-FUNCTION 1 to 8 / Main input GET FROM 1 to 8.....	56
3.10.5 MULTI-FUNCTION 1 to 8 / Aux input GET FROM 1 to 8.....	57
3.10.6 MULTI-FUNCTION 1 to 8 / GOTO 1 to 8.....	57
<b>3.11 APPLICATION BLOCKS / LATCH.....</b>	<b>58</b>
3.11.1 LATCH / Block diagram.....	58
3.11.2 LATCH / Latch output monitor PIN 560.....	58
3.11.3 LATCH / Latch data input PIN 561.....	58
3.11.4 LATCH / Latch clock input PIN 562.....	59
3.11.5 LATCH / Latch set input PIN 563.....	59

3.11.6	LATCH / Latch reset input	PIN 564	59
3.11.7	LATCH / Latch output value for HI/LOW	PINs 565 / 566	59
<b>3.12</b>	<b>APPLICATION BLOCKS / FILTER 1, 2</b>		<b>60</b>
3.12.1	FILTER / Block diagram		60
3.12.2	FILTER 1, 2 / Filter output monitor	PIN 568 / 573	60
3.12.3	FILTER 1, 2 / Filter time constant	PIN 569 / 574	60
3.12.4	FIXED LOW PASS FILTER		61
<b>3.13</b>	<b>APPLICATION BLOCKS / BATCH COUNTER</b>		<b>62</b>
3.13.1	BATCH COUNTER / Block diagram		62
3.13.2	BATCH COUNTER / Counter count monitor	PIN 578	62
3.13.3	BATCH COUNTER / Clock input	PIN 579	63
3.13.4	BATCH COUNTER / Reset input	PIN 580	63
3.13.5	BATCH COUNTER / Counter target number	PIN 581	63
3.13.6	BATCH COUNTER / Count equal or greater than target flag	PIN 582	63
<b>3.14</b>	<b>APPLICATION BLOCKS / INTERVAL TIMER</b>		<b>64</b>
3.14.1	INTERVAL TIMER / Block diagram		64
3.14.2	INTERVAL TIMER / Time elapsed monitor	PIN 583	64
3.14.3	INTERVAL TIMER / Timer reset enable	PIN 584	64
3.14.4	INTERVAL TIMER / Time interval setting	PIN 585	65
3.14.5	INTERVAL TIMER / Timer expired flag	PIN 586	65
<b>3.15</b>	<b>APPLICATION BLOCKS / COMPARATOR 1 to 4</b>		<b>66</b>
3.15.1	COMPARATOR 1 / Block diagram		66
3.15.2	COMPARATOR 1/2/3/4 / Input 1	PIN 588/592/596/600	66
3.15.3	COMPARATOR 1/2/3/4 / Input 2	PIN 589/593/597/601	66
3.15.4	COMPARATOR 1/2/3/4 / Window mode select	PIN 590/594/598/602	67
3.15.5	COMPARATOR 1/2/3/4 / Hysteresis	PIN 591/595/599/603	67
3.15.6	COMPARATOR 1/2/3/4 / Comparator GOTO		67
<b>3.16</b>	<b>APPLICATION BLOCKS / C/O SWITCH 1 to 4</b>		<b>67</b>
3.16.1	C/O SWITCH / Block diagram		67
3.16.1.1	C/O switch used as sample and hold function		68
3.16.2	C/O SWITCH 1/2/3/4 / Control	PIN 604/607/610/613	68
3.16.3	C/O SWITCH 1/2/3/4 / Inputs HI/LO	PIN 605/608/611/614 / 606/609/612/615	68
3.16.4	C/O SWITCH 1/2/3/4 / C/O switch GOTO		68
<b>4</b>	<b>PIN table</b>		<b>69</b>
4.1.1	Change parameters	2 - 121	69
4.1.2	Diagnostics and alarms	123 - 183	71
4.1.3	Serial links	187 - 249	72
4.1.4	Configuration	251 - 400	72
4.1.5	Application blocks	401 - 680	74
4.1.6	Hidden pins	680 - 720	78
<b>5</b>	<b>Index</b>		<b>79</b>
<b>6</b>	<b>Record of PLA manual modifications</b>		<b>79</b>
<b>7</b>	<b>Record of PLA blocks bug fixes</b>		<b>79</b>
<b>8</b>	<b>Changes to product since manual publication</b>		<b>79</b>

## 1.1 Introduction

The **PLA (Programmable logic arithmetic) unit** exploits the same versatile functionality as the the PL/X digital DC motor drive. The product uses the same control hardware and software as the PL/X but has been re-packaged, without the motor power components, to provide a competitive solution to a host of system requirements.

**As the software is identical to the PL/X digital DC motor drive, the PLA should always be operated as if it were a stationary drive. This achieved by ensuring CSTOP on terminal 35 is low. (Left open).**

All the menus available in the PL/X are also available in the PLA. This includes the motor control loops, as some functionality of these may be required by the user, for example the encoder calibration menus. At the back of the manual is a complete Parameter Identification Number (PIN) table. It includes the entire collection

of applications blocks, control terminal setups etc. It also assists in identifying useful parameters within the motor control blocks that may be utilised by the PLA, even though the PLA is not directly driving a motor.

Retaining compatibility with the PL/X allows the same free PL PILOT configuration tool to be used with the PLA, and also provides a familiar menu to users of the PL/X. All the standard FIELDBUS options are also available for use with the PLA unit.

The unit has the same footprint as the PL/X5, but is lower in height. The PLA only requires a power supply of 24V DC at 25 Watts.

The wealth of standard versatile analogue and digital inputs and outputs will make the PLA the product of choice for systems users. The internal applications blocks provide a catalogue of functionality that would individually cost many times more than the unit alone.

## 1.2 General Warnings

### READ AND UNDERSTAND THIS MANUAL BEFORE APPLYING POWER TO THE PLA UNIT

**This manual describes the application blocks available in the PLA. It should be used in conjunction with the main manual (PL / PLX Digital DC Drive product manual).**

The PLA controller is an open chassis component for use in a suitable enclosure

Drives and process control systems are a very important part of creating better quality and value in the goods for our society, but they must be designed, installed and used with great care to ensure everyone's SAFETY. Remember that the equipment you may be using incorporates...

High voltage electrical equipment  
Powerful rotating machinery with large stored energy  
Heavy components

Your process may involve...

Hazardous materials  
Expensive equipment and facilities  
Interactive components

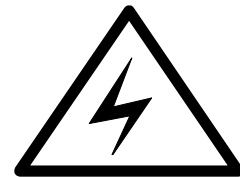

DANGER  
ELECTRIC SHOCK RISK

Always use qualified personnel to design, construct and operate your systems and keep **SAFETY** as your primary concern.

Thorough personnel training is an important aid to **SAFETY** and productivity.

**SAFETY** awareness not only reduces the risk of accidents and injuries in your plant, but also has a direct impact on improving product quality and costs.

If you have any doubts about the **SAFETY** of your system or process, consult an expert immediately. Do not proceed without doing so.

### HEALTH AND SAFETY AT WORK

Electrical devices can constitute a safety hazard. It is the responsibility of the user to ensure the compliance of the installation with any acts or bylaws in force. Only skilled personnel should install and maintain this equipment after reading and understanding this instruction manual. If in doubt refer to the supplier.

Note. The contents of this manual are believed to be accurate at the time of printing. The manufacturers, however, reserve the right to change the content and product specification without notice. No liability is accepted for omissions or errors. No liability is accepted for the installation or fitness for purpose or application of the PLA unit.

### 1.3 Warnings and Instructions

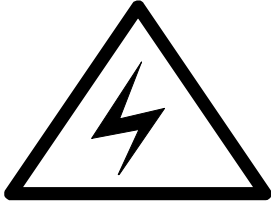

#### WARNING

Only qualified personnel who thoroughly understand the operation of this equipment and any associated machinery should install, start-up or attempt maintenance of this equipment. Non compliance with this warning may result in personal injury and/or equipment damage. Never work on any control equipment without first isolating all power supplies from the equipment. Failure to do so presents an electrical shock hazard.



#### CAUTION

This equipment was tested before it left our factory. However, before installation and start-up, inspect all equipment for transit damage, loose parts, packing materials etc. This product conforms to IPOO protection. Due consideration should be given to environmental conditions of installation for safe and reliable operation. Never perform high voltage resistance checks on the wiring without first disconnecting the product from the circuit being tested.

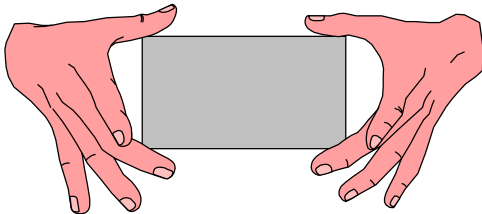

#### STATIC SENSITIVE

This equipment contains electrostatic discharge (ESD) sensitive parts. Observe static control precautions when handling, installing and servicing this product.

**THESE WARNINGS AND INSTRUCTIONS ARE INCLUDED TO ENABLE THE USER TO OBTAIN MAXIMUM EFFECTIVENESS AND TO ALERT THE USER TO SAFETY ISSUES**

**APPLICATION AREA:** Industrial (non-consumer)

**PRODUCT MANUAL:** This manual is intended to provide a description of how the product works. It is not intended to describe the apparatus into which the product is installed.

This manual is to be made available to all persons who are required to design an application, install, service or come into direct contact with the product.

**APPLICATIONS ADVICE:** Applications advice and training is available from Bardac Corporation.



## 1.4 General Risks

### INSTALLATION:

#### **THIS PRODUCT IS CLASSIFIED AS A COMPONENT AND MUST BE USED IN A SUITABLE ENCLOSURE**

Ensure that mechanically secure fixings are used as recommended.



Ensure that cables and wire terminations are as recommended and clamped to required torque.  
Ensure that a competent person carries out the installation and commissioning of this product.  
Ensure that the product rating is not exceeded.

### APPLICATION RISK:

#### **ELECTROMECHANICAL SAFETY IS THE RESPONSIBILITY OF THE USER**

The integration of this product into other apparatus or systems is not the responsibility of the manufacturer or distributor of the product.



The applicability, effectiveness or safety of operation of this equipment, or that of other apparatus or systems is not the responsibility of the manufacturer or distributor of the product.

Where appropriate the user should consider some aspects of the following risk assessment.

**RISK ASSESSMENT:** Under fault conditions or conditions not intended.

- |  |   |
|--|---|
| 1. Machine speeds may be incorrect.                    | 2. The machine speeds may be excessive. |
| 3. The direction of machine rotation may be incorrect. | 4. The machine may be energised.        |

In all situations the user should provide sufficient guarding and/or additional redundant monitoring and safety systems to prevent risk of injury. NOTE: During a power loss event the product will commence a sequenced shut down procedure and the system designer must provide suitable protection for this case.

### MAINTENANCE:

**Maintenance and repair should only be performed by competent persons using only the recommended spares (or return to factory for repair). Use of unapproved parts may create a hazard and risk of injury.**



**WHEN REPLACING A PRODUCT IT IS ESSENTIAL THAT ALL USER DEFINED PARAMETERS THAT DEFINE THE PRODUCT'S OPERATION ARE CORRECTLY INSTALLED BEFORE RETURNING TO USE. FAILURE TO DO SO MAY CREATE A HAZARD AND RISK OF INJURY.**

**PACKAGING:** The packaging is combustible and if disposed of incorrectly may lead to the generation of toxic fumes, which are lethal.

**WEIGHT:** Consideration should be given to the weight of the product when handling.

**REPAIRS:** Repair reports can only be given if the user makes sufficient and accurate defect reporting.

Remember that the product without the required precautions can represent an electrical hazard and risk of injury, and that rotating machinery is a mechanical hazard.

### PROTECTIVE INSULATION:

1. All exposed metal insulation is protected by basic insulation and **user** bonding to earth i.e. Class 1.
2. Earth bonding is the responsibility of the installer.
3. All signal terminals are protected by basic insulation, and the **user** earth bonding. (Class 1). The purpose of this protection is to allow safe connection to other low voltage equipment and is not designed to allow these terminals to be connected to any un-isolated potential.

### 1.5 PLA dimensions

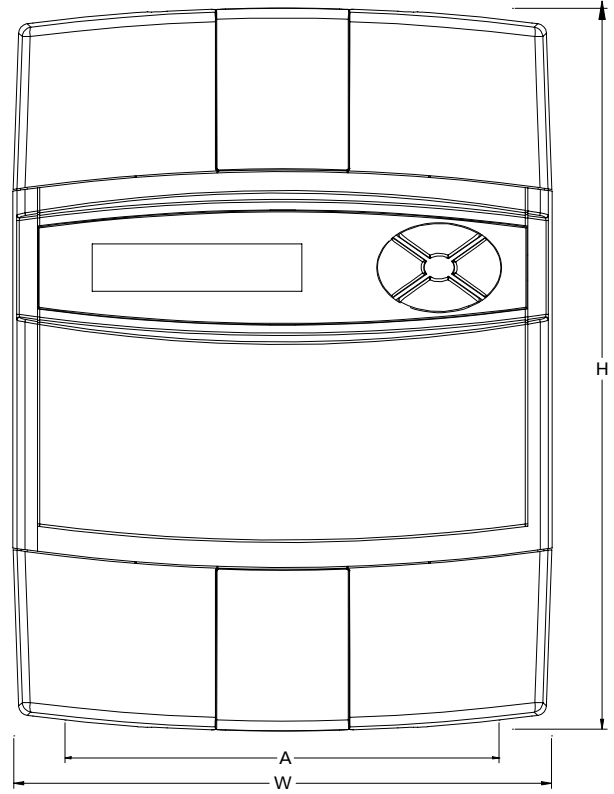
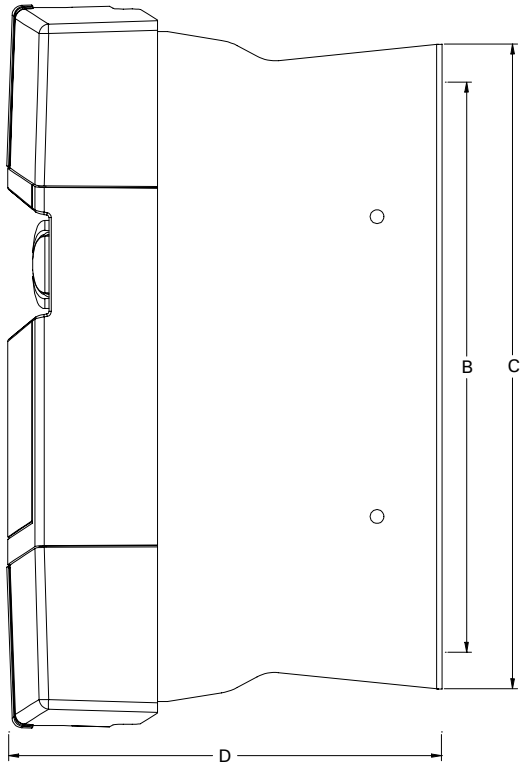

Dimension in mm	PL/X 5-50
W	216
H	289
D	110
A fixing centre	175
B fixing centre	228
C	258

Four corner slots are provided to mount the unit. Use M6 (1/4 in) screws.

Unit weight 2.1 Kg.

## 2 Terminals

### 2.1 Control terminals 1 to 36

This describes the electrical spec. of the control terminals 1 to 36. The function that each terminal has may depend on the programmed choice of the user. The units are shipped with the same set of default terminal functions as the PL/X. Although the function of the terminal may change its electrical specification does not.

<u>UNIVERSAL INPUTS</u>	8 analogue inputs with up to 5mV + sign resolution	0V	1	
	4 input voltage ranges +/-5/10/20/30V on each input	UIP2	2	
<b>UIP2 – UIP9</b>	8 digital inputs with programmable thresholds	UIP3	3	
	Overvoltage protected to +/-50V	UIP4	4	
	Input impedance 100K for input scaling at 5 and 10V range	UIP5	5	
	Input impedance 50K for input scaling above 10V range	UIP6	6	
		UIP7	7	
		UIP8	8	
<u>ANALOGUE OUTPUTS</u>	4 analogue outputs	UIP9	9	
	3 programmable, 1 used to invert/non-invert external signal	AOP1	10	
<b>AOP1 AOP2 AOP3</b>	2.5mV plus sign resolution	AOP2	11	
and <b>IARM</b> on T29	Short circuit protection to 0V. Output current +/-5mA maximum	AOP3	12	
	Output range 0 to +/-11V.			
<u>DIGITAL INPUTS</u>	4 digital inputs	0V	13	
	<b>Logic low below 2V, Logic high above 4V.</b>	DIP1	14	
<b>DIP1 - DIP4</b>	Overvoltage protection to +50V. Input impedance 10K Ohms	DIP2	15	
	<b>DIP3 and DIP4 may also be used for encoder quadrature signals</b>	DIP3	16	
	Encoder input freq. up to 100Khz on DIP3 and DIP4	DIP4	17	
<u>DIGITAL IN/OUTPUTS</u>	4 digital inputs. Also programmable as outputs (see digital outputs)	DIO1	18	
	<b>Logic low below 6V. Logic high above 16V</b>	DIO2	19	
<b>DIO1 – DIO4</b>	Overvoltage protection to +50V. Input impedance 10K Ohms	DIO3	20	
	When used as digital outputs the spec. is the same as DOP1-3	DIO4	21	
<u>DIGITAL OUTPUTS</u>	3 outputs (for 4 more outputs with this spec. use DIO1/2/3/4)	DOP1	22	
	Short circuit protected. (Range 20 to 30 Volts dependant on supply)	DOP2	23	
<b>DOP1 – DOP3</b>	Over-temperature and over-voltage protected to +50V	DOP3	24	
	Each output can deliver up to 350mA. Total for all outputs of 350mA,			
	<u>This spec. also applies to DIO1/2/3/4 when they are programmed as outputs</u>			

This connector is devoted to essentially fixed function controls

<u>TACH INPUT</u>	+/- 200V range	Input impedance 150K Ohms	0V	25	
			TACH	26	
			+10	27	
<u>REFERENCE OUTPUTS</u>	+/-10.00V, 0.2%, 10mA max. Short circuit protection to 0V.		-10	28	
	Output of signal input to T50. Gain 2.5, 75mS filter. Invert/non-invert function. 10mA max		IARM	29	
	May be used as logic input or thermistor detector. See main manual section 8.1.11.6		THM	30	
	NOT normally used. Leave disconnected.		RUN	31	
	NOT normally used. Leave disconnected.		JOG	32	
	NOT normally used. Leave disconnected.		START	33	
	NOT normally used. Leave disconnected.		CSTOP	34	
<b>+24V</b>	Output for external logic ( <b>Range 20 to 30 Volts dependant on input supply</b> )		+24V	35	
	Short circuit protected. Overvoltage protection to +50V.		0V	36	
	Shares total current capability of 'Digital Outputs' (350mA), plus extra 50mA of its own. Total maximum available 400mA.				

2.1.1 Control terminals on lower board numbers 41 - 52

(NC = no connection)

**REMOTE RA +** RA + . isolated + ve input for high DC voltage measurement  
 Isolated DC bi-polar voltage measurement up to +/-1000V. (common mode range 500V)

**REMOTE RA-** RA- isolated -ve input for high DC voltage measurement

**HIGH VOLTAGE AC1** AC1 used for remote sensing of high AC voltages  
 Isolated AC voltage measurement up to +/-700V. (common mode range 500V)

**HIGH VOLTAGE AC2** AC2 used for remote sensing of high AC voltages

RA +	41	
NC	42	
RA-	43	
NC	44	
AC1	45	
NC	46	
AC2	47	
NC	48	
AOV	49	
ACT	50	
	51	
	52	

Analogue IP. OP on T29, Gain 2.5 with +/-1 function, 75mS filter, 100K input impedance

Reserved for future use

Reserved for future use

2.1.2 Remote RA + (T41) and RA- (T43)

The **REMOTE RA** is processed by the 'armature voltage' function. The maximum possible input voltage is +/-1000V. Higher voltages may be pre-scaled prior to connection to the PLA.

Connect the +ve to terminal T41, Connect the -ve to terminal T43

Note. The monitor in DIAGNOSTICS / 126)ARM VOLTS MON is clamped at 1.25 times the setting of CALIBRATION / 18)RATED ARM VOLTS

2.1.3 Common Mode Range

The maximum input voltage of T41 or T43 is +/-1000V with respect to 0 Volts. (Common).

Hence an AVF signal of 1000 volts may at the limit have one side at the same voltage with respect to 0 Volts (Common) and still measure linearly.

An AVF signal of 500 volts may have one terminal at + 500 V with respect to 0 Volts (Common) and the other terminal at +1000V and still measure linearly.

The optimum common mode is for the signal to swing symmetrically with respect to 0 Volts (Com).

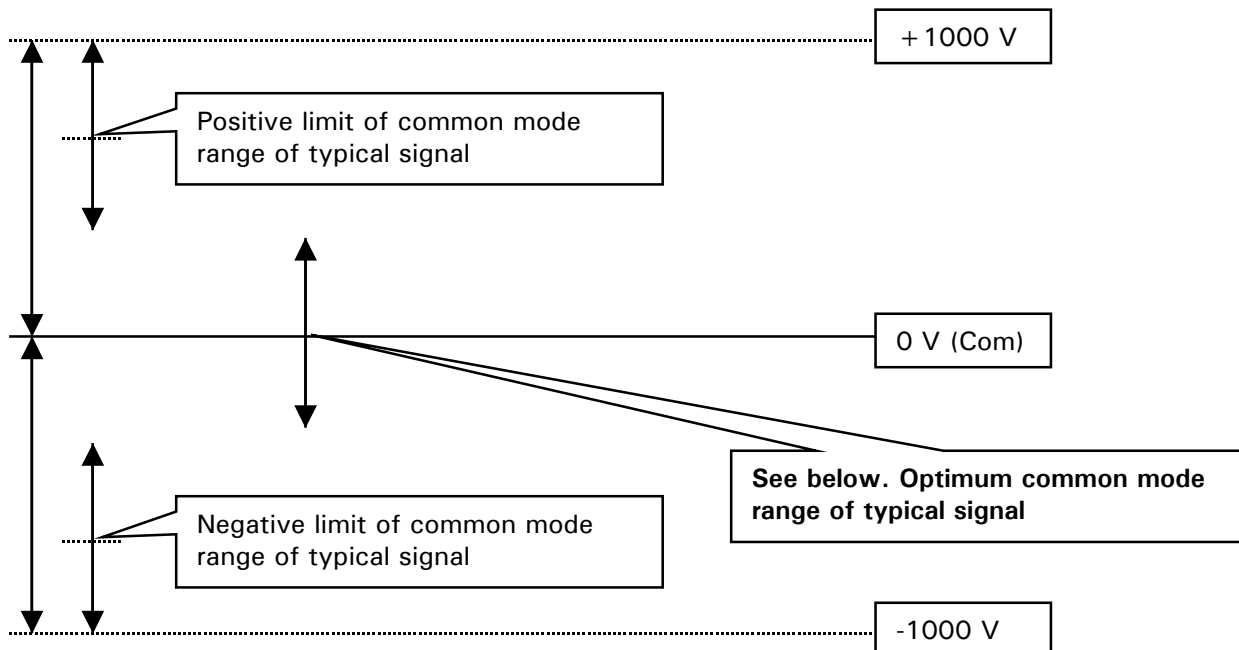

These are absolute limits. You should always make allowances for overshoots, ripple etc.

You should always try to ensure the common mode range is as per the optimum if possible. If the neutral of the 3 phase supply used as the source of the high voltage is close to the earth (which is close to 0V common) then the common mode range will be optimum.

The common mode range may be reduced if the DC supply to the PLA falls below 20 volts.

2.1.4 High voltage AC (T45, T47)

The **HIGH VOLTAGE AC1, AC2** input is processed by the 'EL1/2/3 RMS function'. The maximum possible input voltage is 700V AC. If a DC voltage is entered, it will be rectified and displayed after scaling by 0.7. Prescale higher voltages prior to connection. The monitor is in DIAGNOSTICS / 169)EL1/2/3 RMS MON. The optimum common mode is for the signal to swing symmetrically with respect to 0 Volts (Com).

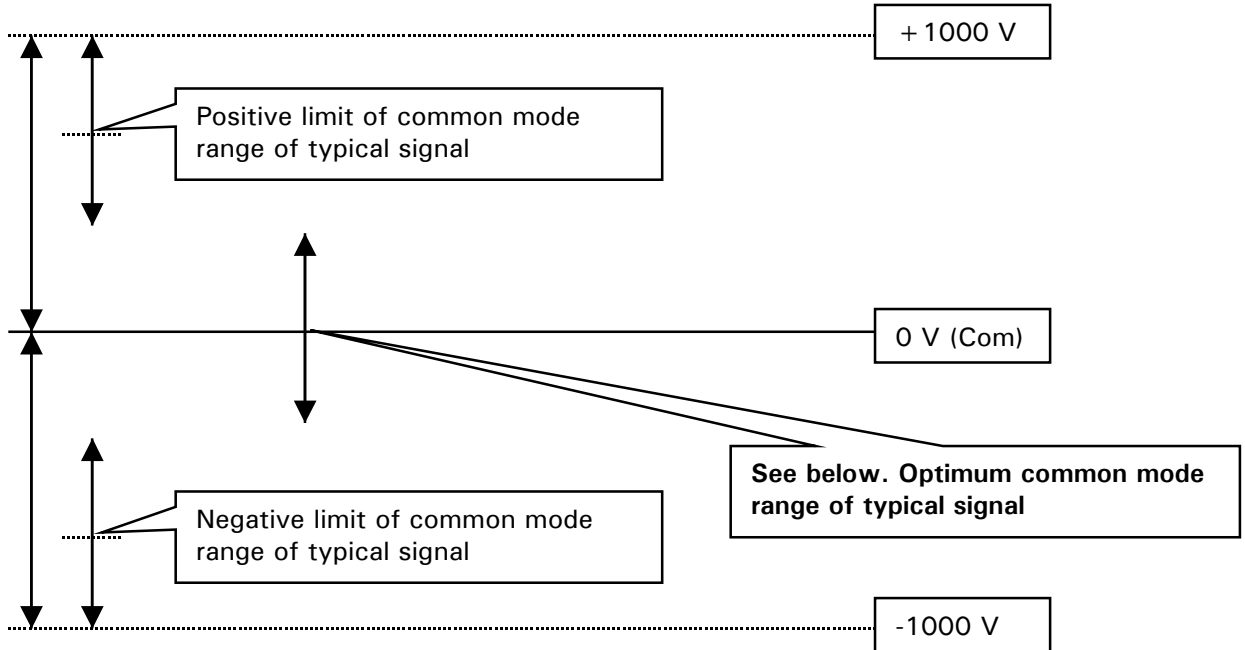

These are absolute limits of the AC peak voltage. You should make allowances for overshoots, ripple etc. You should always try to ensure the common mode range (CMR) is as per the optimum if possible. If the neutral of the 3 phase supply used as the source of the high voltage is close to the earth (which is close to 0V ) then the CMR is optimum. The CMR may be reduced if the DC supply to the PLA falls below 20 volts.

2.1.5 Analogue input ACT. (ACT T50, 0Volts T49)

This analogue input is processed via a +/-1 selectable invert/non-invert buffer, followed by an amplifier with gain 2.5 filter with a time constant of 75mS. The result is output on T29. The parameter for selecting the invert function is in CONFIGURATION / ANALOG OUTPUTS / 250)Iarm OP RECTIFY. A permanently inverted version of the input signal may also be monitored using an oscilloscope on a test pin 'Iarm'. The input impedance is 100K. See 'signal test pins' in section 3 of the main manual.

2.1.6 Control terminals on lower board numbers 53 - 64

- Reserved for future use
- Reserved for future use
- Reserved for future use
- Reserved for future use
- Reserved for future use
- Reserved for future use
- Reserved for future use
- Reserved for future use
- Reserved for future use

0 Volts	53	
	54	
	55	
	56	
	57	
	58	
	59	
	60	
	61	
	62	
	63	
	64	

External DC supply 0 volt connection

External DC supply 24 volt connection 20 Volts minimum, 30V maximum. 25 Watt.

**Note. The supply current requirement for start up with all outputs unloaded is a minimum 0.5 Amp for 0.5s. The current consumption with outputs unloaded is typically 330mA. Increase accordingly if outputs loaded.**

The internal supply is switch-mode and requires proportionately more current if the input voltage reduces. The message INTERNAL ERROR CODE / SUPPLY PHASE LOSS will appear if the supply dips below 16 Volts, or fails to exceed 19 Volts on power up. See section 3.6 Supply Loss shutdown in main manual.

Note. The user digital outputs are allocated a budget of 400mA. If this budget is not fully utilised then the input DC current supply requirement to the PLA is reduced accordingly.



### 3 APPLICATION BLOCKS

- 1 Table of contents and Introduction .....3
- 1.1 Introduction ..... 6
- 1.2 General Warnings ..... 7
- 1.3 Warnings and Instructions ..... 8
- 1.4 General Risks ..... 9
- 1.5 PLA dimensions..... 10
- 2 Terminals..... 11
- 2.1 Control terminals 1 to 36..... 11
- 3 APPLICATION BLOCKS ..... 15
- 3.1 General rules..... 15
- 3.2 APPLICATION BLOCKS / SUMMER 1, 2 ..... 18
- 3.3 APPLICATION BLOCKS / PID 1, 2..... 23
- 3.4 APPLICATION BLOCKS / PARAMETER PROFILER..... 31
- 3.5 APPLICATION BLOCKS / REEL DIAMETER CALC ..... 35
- 3.6 APPLICATION BLOCKS / TAPER TENSION CALC ..... 39
- 3.7 APPLICATION BLOCKS / TORQUE COMPENSATOR ..... 42
- 3.8 Centre winding block arrangement ..... 51
- 3.9 APPLICATION BLOCKS / PRESET SPEED ..... 52
- 3.10 APPLICATION BLOCKS / MULTI-FUNCTION 1 to 8 ..... 55
- 3.11 APPLICATION BLOCKS / LATCH ..... 58
- 3.12 APPLICATION BLOCKS / FILTER 1, 2..... 60
- 3.13 APPLICATION BLOCKS / BATCH COUNTER ..... 62
- 3.14 APPLICATION BLOCKS / INTERVAL TIMER ..... 64
- 3.15 APPLICATION BLOCKS / COMPARATOR 1 to 4..... 66
- 3.16 APPLICATION BLOCKS / C/O SWITCH 1 to 4..... 67
- 4 PIN table..... 69
- 5 Index..... 79
- 6 Record of PLA manual modifications ..... 79
- 7 Record of PLA blocks bug fixes ..... 79
- 8 Changes to product since manual publication ..... 79

#### 3.1 General rules

##### 3.1.1 Sample times

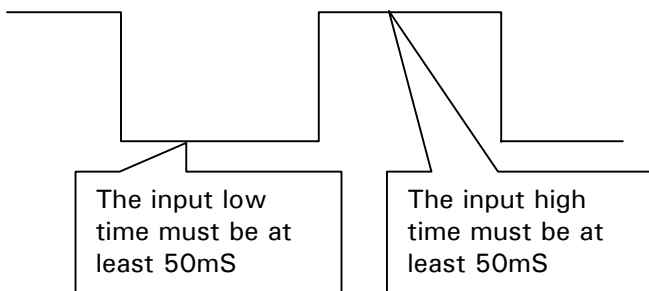

When application blocks are being processed the workload on the internal microprocessor is increased.

With no application blocks activated the time taken to perform all the necessary tasks (cycle time) is approximately 5mS.

With all the application blocks activated the cycle time is approximately 10mS. In the future, the designers expect to add even more application blocks.

It is not expected however that the typical cycle time will ever exceed 30mS. (Bear in mind that it would be highly unusual for all the application blocks to be activated).

With this in mind it is recommended that the system designer takes care that external logic signals are stable long enough to be recognised. In order to achieve this, the logic input minimum dwell time has been specified at 50mS.

It will of course be possible to operate with much lower dwell times than this for simpler installations where the cycle time is low. There is then the risk that a future re-configuration of the blocks by the user would increase the cycle time sufficiently to cause sampling problems.

### 3.1.2 Order of processing

It may be useful for system designers to know the order in which the blocks are processed within each cycle.

0) Analogue inputs	12) Torque compensator
1) Motorised pot	13) Zero interlocks
2) Digital inputs	14) Speed control
3) Reference exchange	15) Preset speed
4) Jumpers	16) Parameter profile
5) Multi-function	17) Latch
6) Alarms	18) Batch counter
7) PID1, 2	19) Interval timer
8) Summer 1, 2	20) Filters
9) Run mode ramps	21) Comparators
10) Diameter calc	22) C/O Switches
11) Taper tension	23) All terminal outputs

### 3.1.3 Logic levels

Logic inputs will recognise the value **zero**, (any units), as a logic low. All other numbers, including negative numbers, will be recognised as a logic high.

### 3.1.4 Activating blocks

In order to activate a block it is necessary to configure its GOTO window to a PIN other than 400)Block disconnect. In the CONFIGURATION menu first enter the ENABLE GOTO, GETFROM window and set it to ENABLED. Then staying in the CONFIGURATION menu proceed to BLOCK OP CONFIG to find the appropriate GOTO. (Note, The GOTO windows for Multi function 1- 8, Comparator 1-4 and C/O switch 1-4 are contained within each block menu for convenience). After completing the connection return to the ENABLE GOTO, GETFROM window and set it to DISABLED.

### 3.1.5 CONFLICT HELP MENU

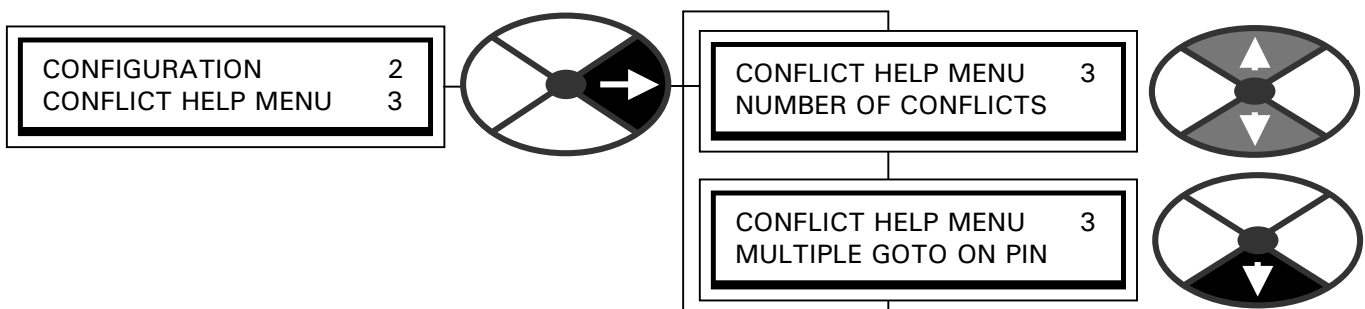

If there has been an accidental connection of more than one GOTO to any PIN, then when the ENABLE GOTO, GETFROM is set to DISABLED, (this is done at the end of a configuration session), the automatic conflict checker will give the alarm message GOTO CONFLICT. This menu is provided to assist the user in locating the PIN with the GOTO conflict.

Proceed to the CONFLICT HELP MENU in the CONFIGURATION menu (see product manual) to find the number of conflicting GOTO connections, and the target PIN that causes the conflict. One of the GOTO connections must be removed to avoid the conflict.

This process is repeated until there are no conflicts.

Note that this tool is extremely helpful. Without it there is the possibility that user GOTO configuration errors would cause multiple values to alternately appear at the conflict PIN resulting in unusual system behaviour.



APPLICATION BLOCKS menu  
 The application blocks can be used to create complex control applications.

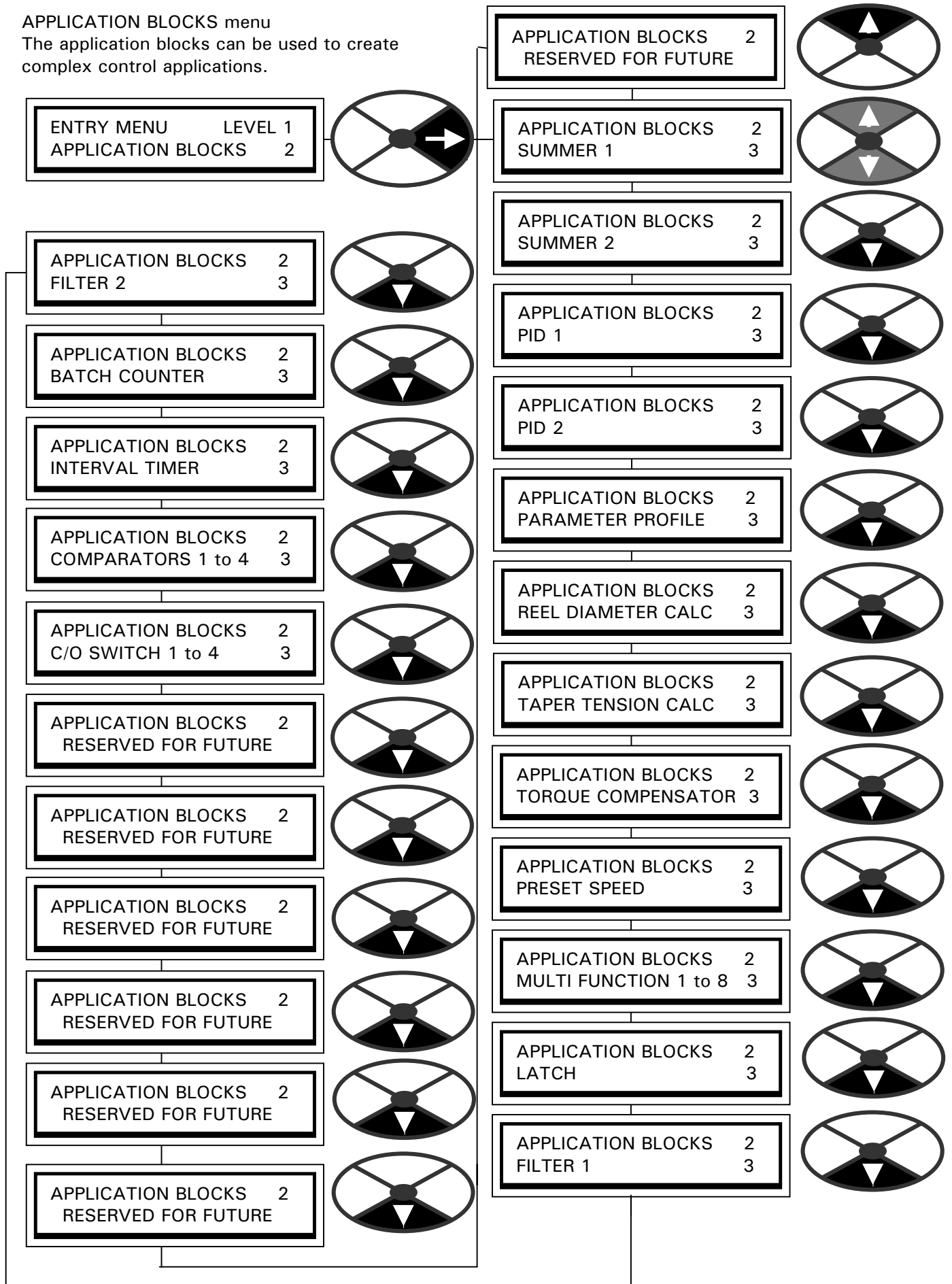

### 3.2 APPLICATION BLOCKS / SUMMER 1, 2

PIN number range 401 to 427.

APPLICATION BLOCKS	2
SUMMER 1	3

Summer 1 and 2 are identical apart from the PIN numbers. The PIN numbers for both summers are in the section headings.

There are 2 hidden PINs in each block for CH1 and CH2 subtotal outputs.

SUMMER1: Pins 691 and 692.

SUMMER2: Pins 693 and 694.

This menu allows programming of a general purpose signal summing and scaling block.

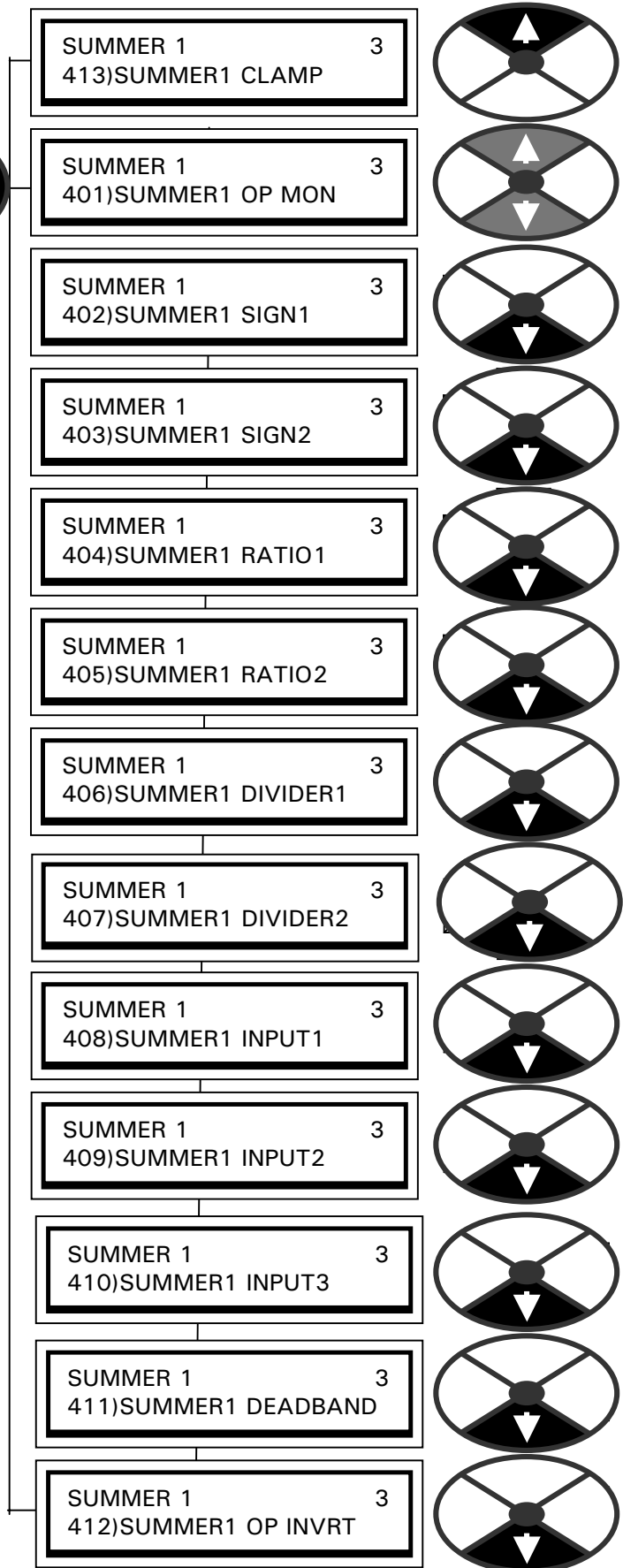

3.2.1 SUMMER 1, 2 / Block diagram

There are 2 identical independant SUMMER blocks

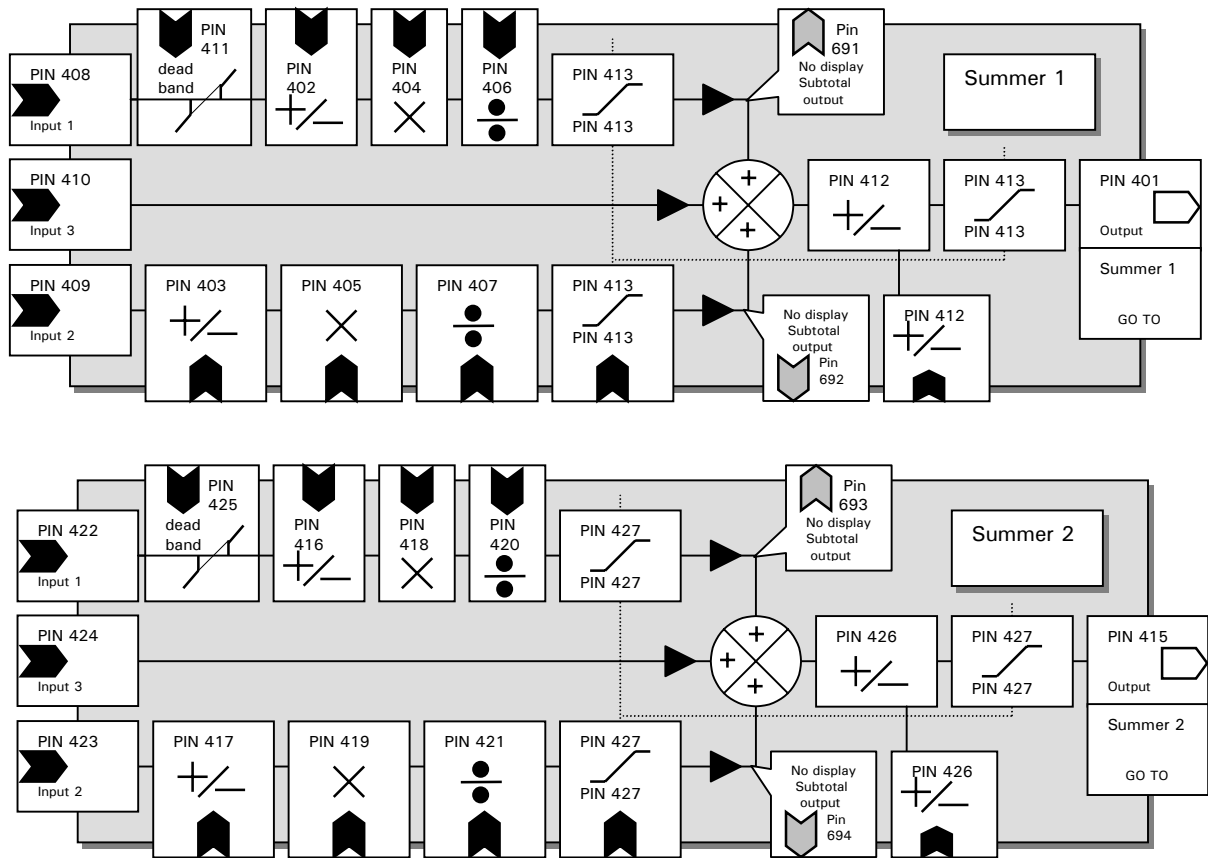

3.2.2 SUMMER 1, 2 / Total output monitor PIN 401 / 415

SUMMER 1

401)SUMMER1 OP MON

3

401)SUMMER1 OP MON

0.00%

Monitors the final total output value of the summer block.

PARAMETER	RANGE	DEFAULT	PIN
SUMMER1 OP MON	+/-200.00%	0.00%	401

3.2.3 SUMMER 1, 2 / Sign 1 PIN 402 / 416

SUMMER 1

402)SUMMER1 SIGN1

3

402)SUMMER1 SIGN1

NON-INVERT

Used to invert the signal arriving at input 1.

PARAMETER	RANGE	DEFAULT	PIN
SUMMER1 SIGN1	INVERT or NON-INVERT	NON-INVERT	402

3.2.4 SUMMER 1, 2 / Sign 2 PIN 403 / 417

SUMMER 1 3  
403)SUMMER1 SIGN2

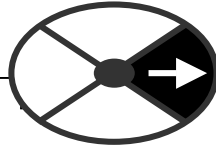

403)SUMMER1 SIGN2  
NON-INVERT

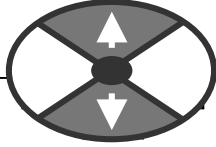

Used to invert the signal arriving at input 2.

PARAMETER	RANGE	DEFAULT	PIN
SUMMER1 SIGN 2	INVERT or NON-INVERT	NON-INVERT	403

3.2.5 SUMMER 1, 2 / Ratio 1 PIN 404 / 418

SUMMER 1 3  
404)SUMMER1 RATIO1

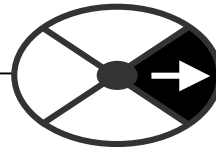

404)SUMMER1 RATIO1  
1.0000

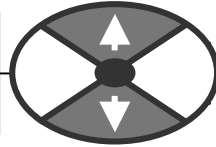

Sets the ratio value for the signal arriving at input 1.

PARAMETER	RANGE	DEFAULT	PIN
SUMMER1 RATIO1	+/-3.0000	1.0000	404

3.2.6 SUMMER 1, 2 / Ratio 2 PIN 405 / 419

SUMMER 1 3  
405)SUMMER1 RATIO2

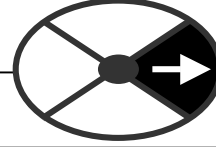

405)SUMMER1 RATIO2  
1.0000

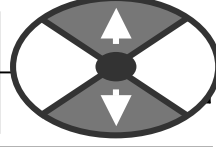

Sets the ratio value for the signal arriving at input 2.

PARAMETER	RANGE	DEFAULT	PIN
SUMMER1 RATIO2	+/-3.0000	1.0000	405

3.2.7 SUMMER 1, 2 / Divider 1 PIN 406 / 420

SUMMER 1 3  
406)SUMMER1 DIVIDER1

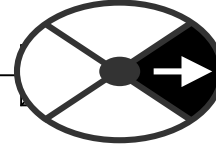

406)SUMMER1 DIVIDER1  
1.0000

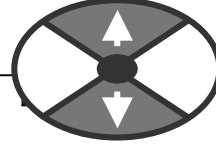

Sets divisor for signal arriving at IP1. A zero gives zero output

PARAMETER	RANGE	DEFAULT	PIN
SUMMER1 DIVIDER1	+/-3.0000	1.0000	406

3.2.8 SUMMER 1, 2 / Divider 2 PIN 407 / 421

SUMMER 1 3  
407)SUMMER1 DIVIDER2

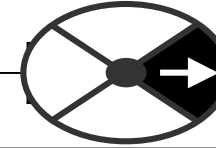

407)SUMMER1 DIVIDER2  
1.0000

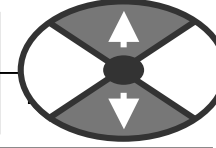

Sets divisor for signal arriving at IP2. A zero gives zero output

PARAMETER	RANGE	DEFAULT	PIN
SUMMER1 DIVIDER2	+/-3.0000	1.0000	407

3.2.9 SUMMER 1, 2 / Input 1 PIN 408 / 422

SUMMER 1 3  
408)SUMMER1 INPUT1

408)SUMMER1 INPUT1  
0.00%

Sets value for input 1.

PARAMETER	RANGE	DEFAULT	PIN
SUMMER1 INPUT1	+/-300.00%	0.00%	408

3.2.10 SUMMER 1, 2 / Input 2 PIN 409 / 423

SUMMER 1 3  
409)SUMMER1 INPUT2

409)SUMMER1 INPUT2  
0.00%

Sets value for input 2.

PARAMETER	RANGE	DEFAULT	PIN
SUMMER1 INPUT2	+/-300.00%	0.00%	409

3.2.11 SUMMER 1, 2 / Input 3 PIN 410 / 424

SUMMER 1 3  
410)SUMMER1 INPUT3

410)SUMMER1 INPUT3  
0.00%

Sets value for input 3.

PARAMETER	RANGE	DEFAULT	PIN
SUMMER1 INPUT3	+/-300.00%	0.00%	410

3.2.12 SUMMER 1, 2 / Deadband PIN 411 / 425

SUMMER 1 3  
411)SUMMER1 DEADBAND

411)SUMMER1 DEADBAND  
0.00%

Sets +/- % deadband width centred on 0.00% for input 1.

PARAMETER	RANGE	DEFAULT	PIN
SUMMER1 DEADBAND	0.00 to 100.00%	0.00%	411

3.2.13 SUMMER 1, 2 / Output sign inverter PIN 412 / 426

SUMMER 1 3  
412)SUMMER1 OP INVRT

412)SUMMER1 OP INVRT  
NON-INVERT

Used to invert the output signal from the summing block.

PARAMETER	RANGE	DEFAULT	PIN
SUMMER1 OP INVRT	INVERT / NON-INVERT	NON-INVERT	412

3.2.14 SUMMER 1, 2 / Symmetrical clamp PIN 413 / 427

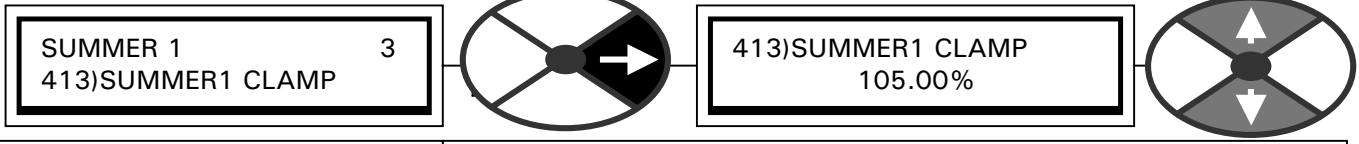

Sets the value of a symmetrical clamp for inputs 1, 2 and output	PARAMETER	RANGE	DEFAULT	PIN
	SUMMER1 CLAMP	0.00 to 200.00%	105.00%	413

The subtotal values after clamping for SUMMER1 are available on hidden PIN 691 (CH1) and 692 (CH2)  
 The subtotal values after clamping for SUMMER2 are available on hidden PIN 693 (CH1) and 694 (CH2)

### 3.3 APPLICATION BLOCKS / PID 1, 2.

There are 2 identical PID blocks.  
Pins 429 to 474

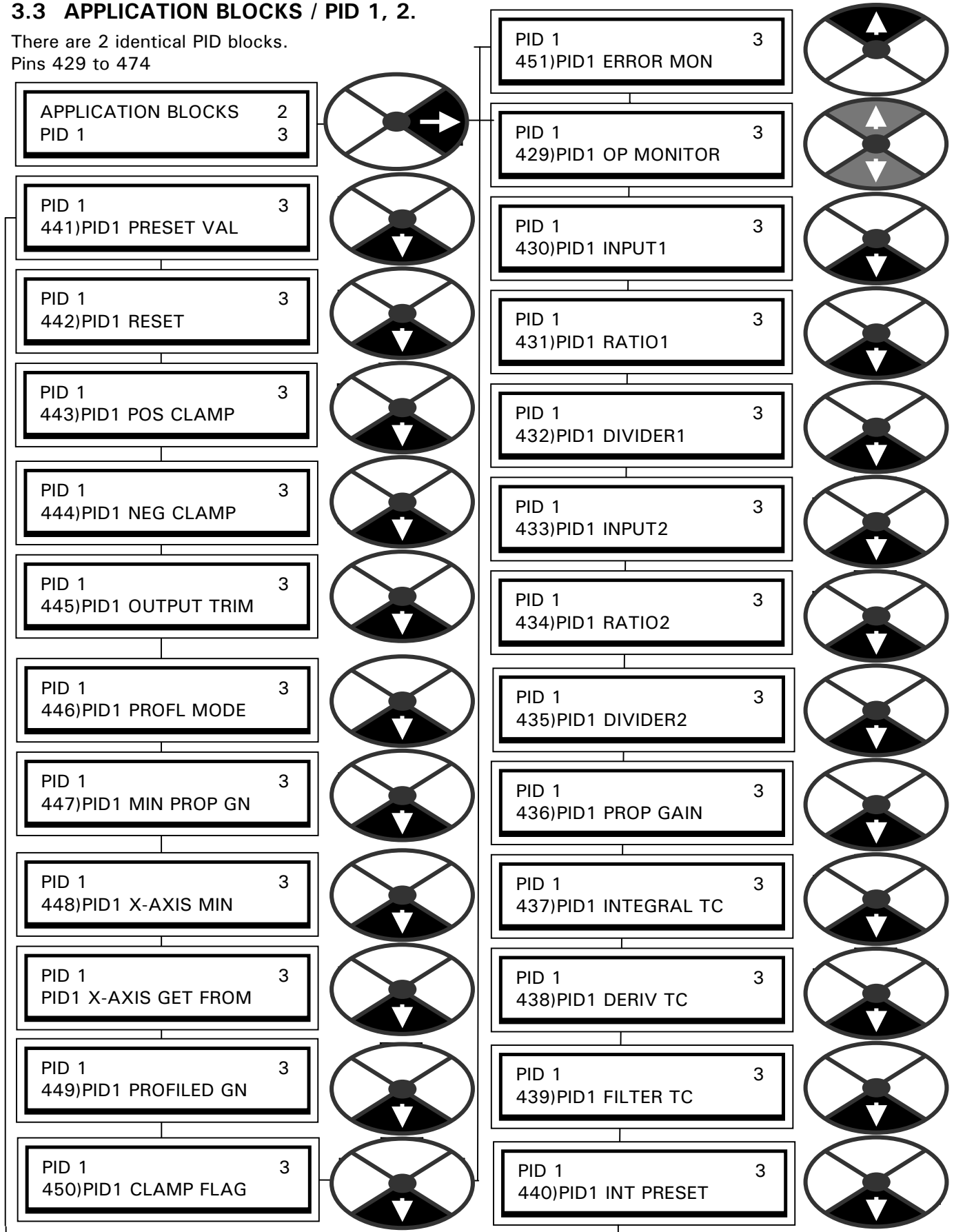

This block performs the function of a classical PID.

Typical uses in motion control applications are, Dancer arm, loadcell tension, centre driven winding.

Features:-

Independent adjustment and selection of P, I, D.

Scaling of feedback and reference inputs.

Adjustable filter.

Preset mode on integral term.

Output scaler with independent +/-limit clamps.

Built in gain profiling option.

3.3.1 PID 1, 2 / Block diagram

2 identical independant PID blocks

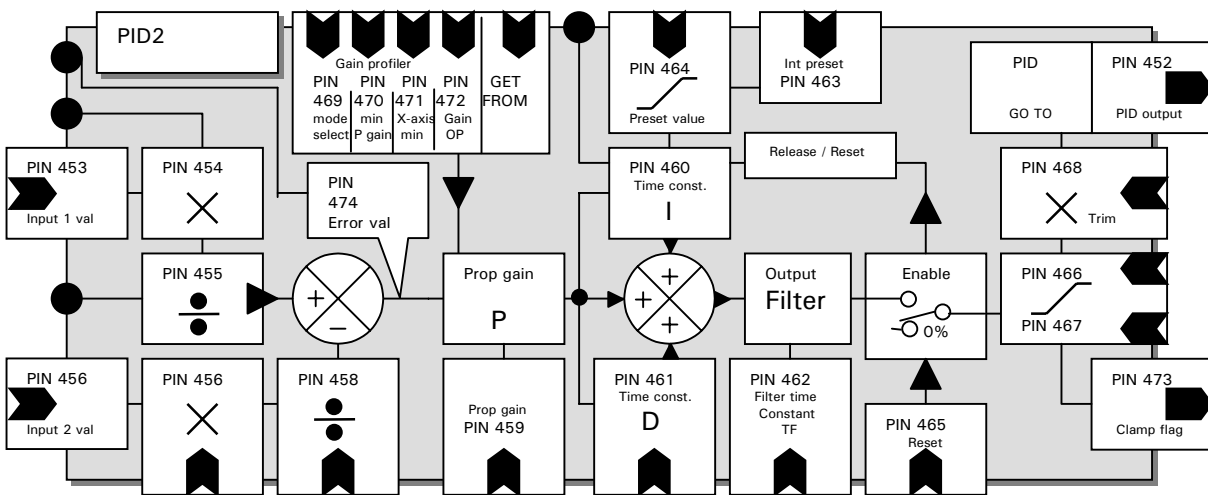
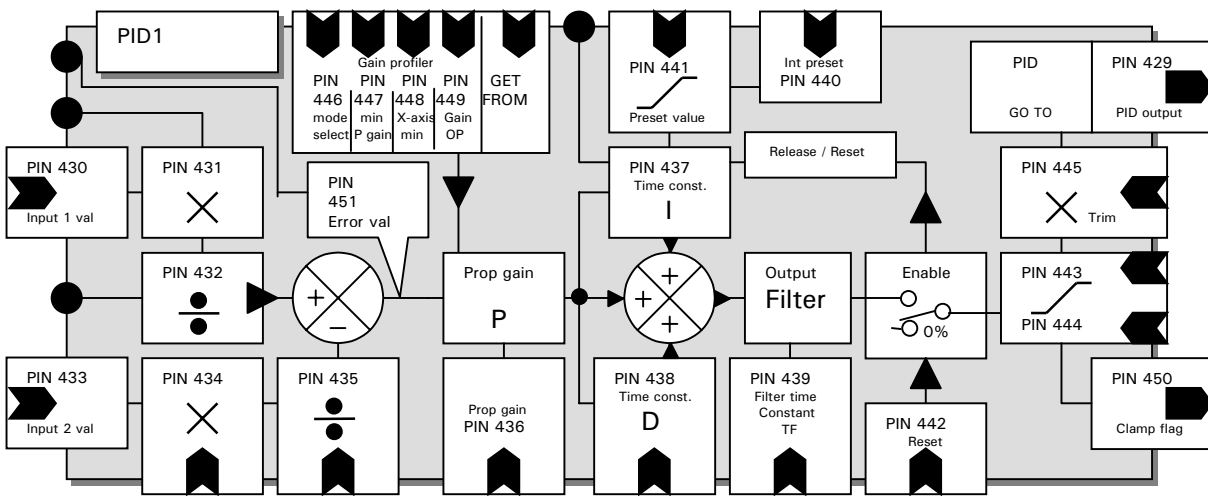



3.3.2 PID 1, 2 / PID output monitor PIN 429 / 452

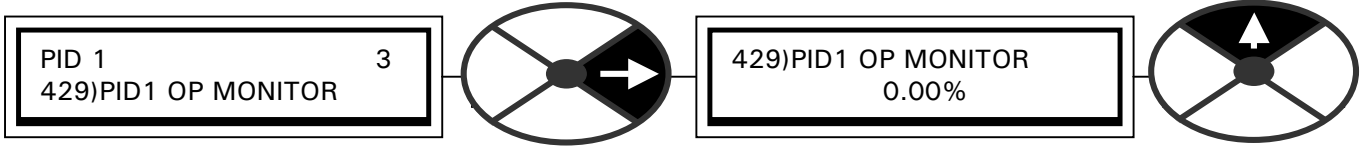

This is the final output of the PID1 block.

PARAMETER	RANGE	PIN
PID1 OP MONITOR	+/-300.00%	429

This window has a branch hopping facility to 3.3.25 PID 1, 2 / PID error value monitor PIN 451 / 474

3.3.3 PID 1, 2 / PID IP1 value PIN 430 / 453

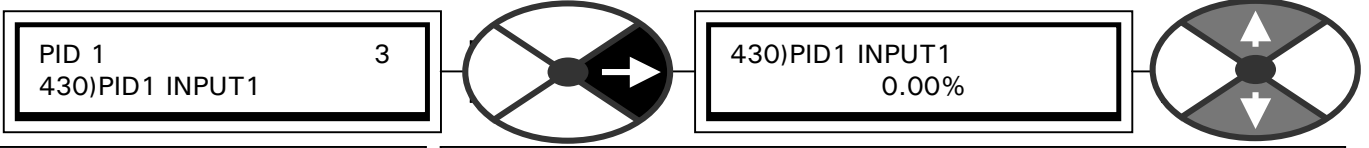

Sets value for PID input 1. This is normally the PID reference.

PARAMETER	RANGE	DEFAULT	PIN
PID1 INPUT1	+/-300.00%	0.00%	430

3.3.4 PID 1, 2 / PID IP1 ratio PIN 431 / 454

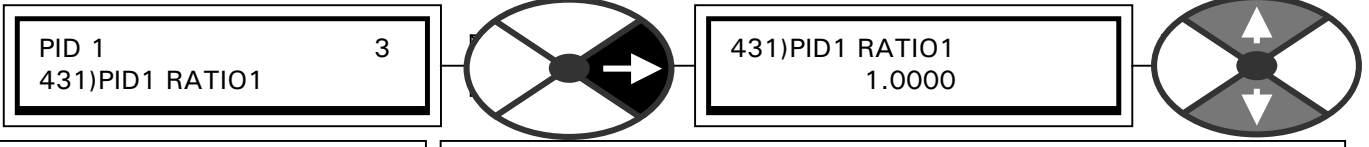

Sets the scaling factor for the PID input 1 value.

PARAMETER	RANGE	DEFAULT	PIN
PID1 RATIO1	+/-3.0000	1.0000	431

3.3.5 PID 1, 2 / PID IP1 divider PIN 432 / 455

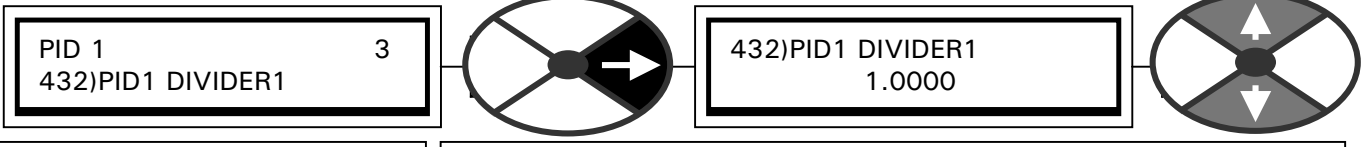

Sets divisor for IP1 signal channel. Zero gives zero output

PARAMETER	RANGE	DEFAULT	PIN
PID1 DIVIDER1	+/-3.0000	1.0000	432

3.3.6 PID 1, 2 / PID IP2 value PIN 433 / 456

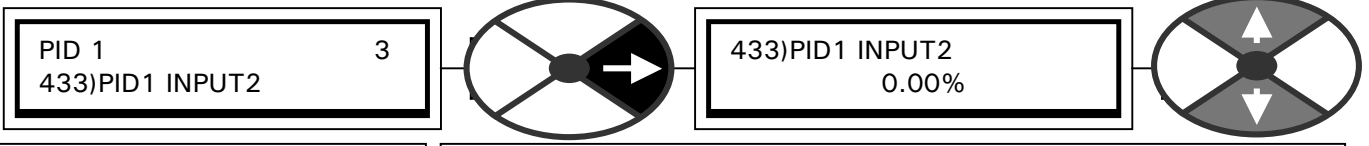

Sets value for PID input 2. This is normally the PID reference.

PARAMETER	RANGE	DEFAULT	PIN
PID1 INPUT2	+/-300.00%	0.00%	433

3.3.7 PID 1, 2 / PID IP2 ratio PIN 434 / 457

PID 1 3

434)PID1 RATIO2

434)PID1 RATIO2

1.0000

Sets the scaling factor for the PID input 2 value.

PARAMETER	RANGE	DEFAULT	PIN
PID1 RATIO2	+/-3.0000	1.0000	434

3.3.8 PID 1, 2 / PID IP2 divider PIN 435 / 458

PID 1 3

435)PID1 DIVIDER2

435)PID1 DIVIDER2

1.0000

Sets divisor for IP2 signal channel. Zero gives zero output

PARAMETER	RANGE	DEFAULT	PIN
PID1 DIVIDER2	+/-3.0000	1.0000	435

3.3.9 PID 1, 2 / PID proportional gain PIN 436 / 459

PID 1 3

436)PID1 PROP GAIN

436)PID1 PROP GAIN

1.0

Sets the PID gain independently of the I and D time constants.

PARAMETER	RANGE	DEFAULT	PIN
PID1 PROP GAIN	0.0 to 100.0	1.0	436

Proportional output = gain X (1 + DiffT/IntT) X error%. A higher gain usually provides a faster response. Normally the DiffT is much smaller than IntT, hence the equation then approximates to:-  
 Prop output = gain X error%.

E. g. A gain of 10 and a step change in the error of 10% will result in a step change at the output of 100%.  
 Note. The gain may be profiled using the PARAMETER PROFILE section within this menu.

3.3.10 PID 1, 2 / PID integrator time constant PIN 437 / 460

PID 1 3

437)PID1 INTEGRAL TC

437)PID1 INTEGRAL TC

5.00 SECS

Sets the PID integrator time constant.

PARAMETER	RANGE	DEFAULT	PIN
PID1 INTEGRAL TC	0.01 to 100.00 seconds	5.00 secs	437

Note. Processes that take a long time to react will usually require a longer integrator time constant. When the PID output reaches the clamp limits the integrator is held at the prevailing condition. The clamp levels are also separately applied to the internal integrator term result. See 3.3.16 and 3.3.17 .PID 1, 2 / PID negative clamp level PIN 444 / 467

3.3.11 PID 1, 2 / PID derivative time constant PIN 438 / 461

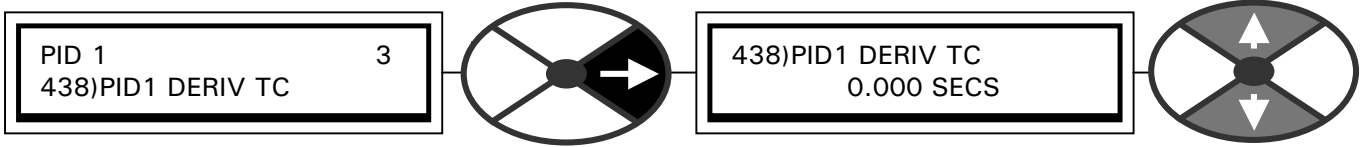

Sets the PID derivative time constant.

PARAMETER	RANGE	DEFAULT	PIN
PID1 DERIV TC	0.000 to 10.000 seconds	0.000 secs	438

If the derivative time constant is set to 0.000, then the D term is effectively removed from the block. Loops that require a rapid response but suffer from overshoot normally benefit from a smaller derivative time constant.

3.3.12 PID 1, 2 / PID derivative filter time constant PIN 439 / 462

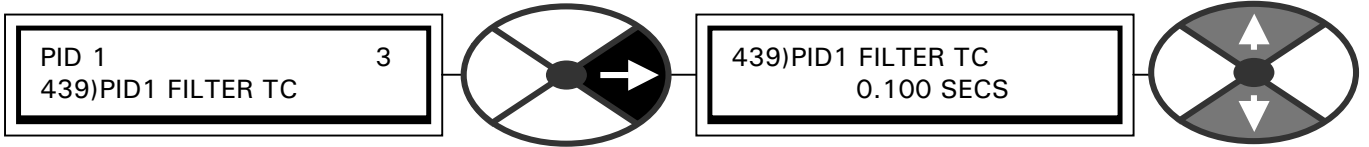

Sets the time constant of the PID output filter.

PARAMETER	RANGE	DEFAULT	PIN
PID1 FILTER TC	0.000 to 10.000 seconds	0.100 secs	439

The derivative of a noisy error signal can lead to unwanted output excursions. This filter time constant is typically set at DERIV TC/5 (See above). A time constant of 0.000 will turn the filter off. The filter is applied to the sum of the P, I and D terms.

3.3.13 PID 1, 2 / PID integrator preset PIN 440 / 463

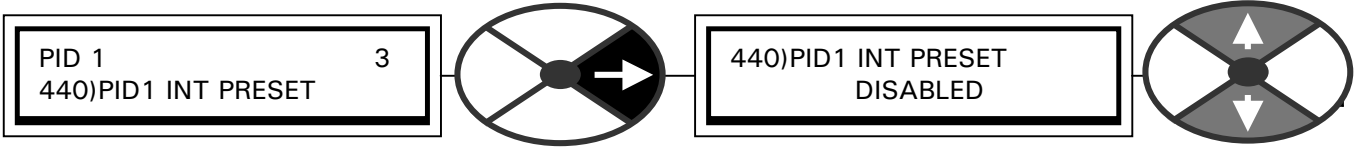

Enables the integrator to be preset to the value in PIN 761.

PARAMETER	RANGE	DEFAULT	PIN
PID1 INT PRESET	ENABLED or DISABLED	DISABLED	440

Note. The PID INT PRESET function operates independantly from the PID RESET function. If the integrator preset is permanently enabled then the I term is effectively removed from the block.

3.3.14 PID 1, 2 / PID integrator preset value PIN 441 / 464

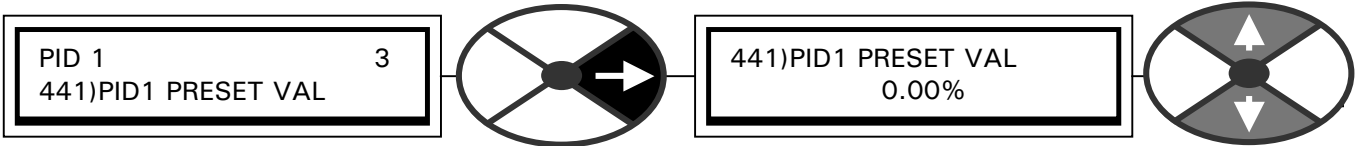

This integrator preset value is enabled by PID1 INT PRESET.

PARAMETER	RANGE	DEFAULT	PIN
PID1 PRESET VAL	+/-300.00%	0.00%	441

Note. The preset function is overridden by the PID RESET function.

3.3.15 PID 1, 2 / PID reset PIN 442 / 465

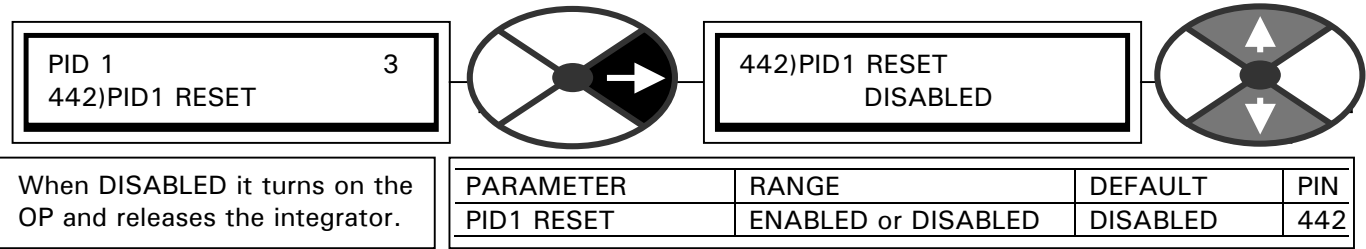

When DISABLED it turns on the OP and releases the integrator.

Note. When the reset is ENABLED the output stage and the integrator are set to 0.00%.  
 Note. The PID RESET operates independantly from and has priority over the integrator preset function.

3.3.16 PID 1, 2 / PID positive clamp level PIN 443 / 466

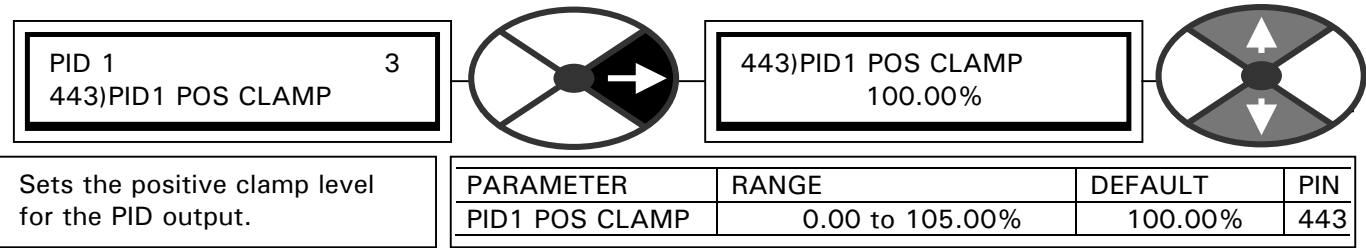

Sets the positive clamp level for the PID output.

Note. When the output is being clamped at this level, the integrator is held at its prevailing value

3.3.17 PID 1, 2 / PID negative clamp level PIN 444 / 467

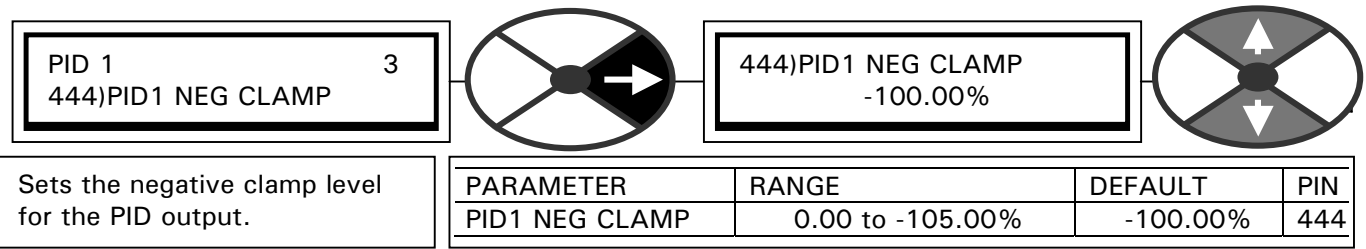

Sets the negative clamp level for the PID output.

Note. When the output is being clamped at this level, the integrator is held at its prevailing value

3.3.18 PID 1, 2 / PID output % trim PIN 445 / 468

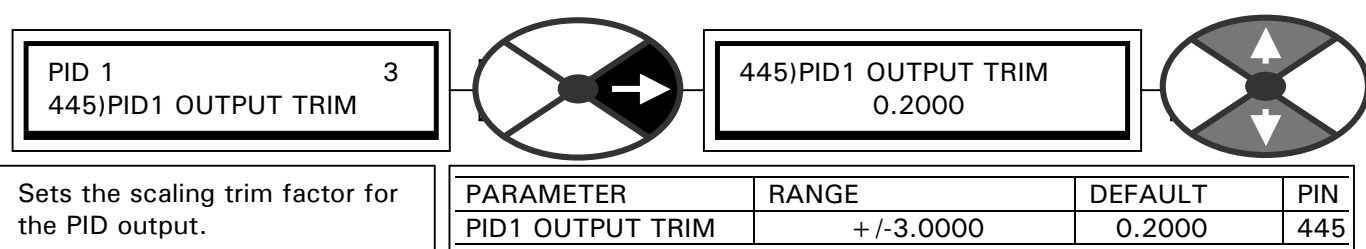

Sets the scaling trim factor for the PID output.

The output of the PID may be inverted by selecting a negative trim factor.

3.3.19 PID 1, 2 / PID profile mode select PIN 446 / 469

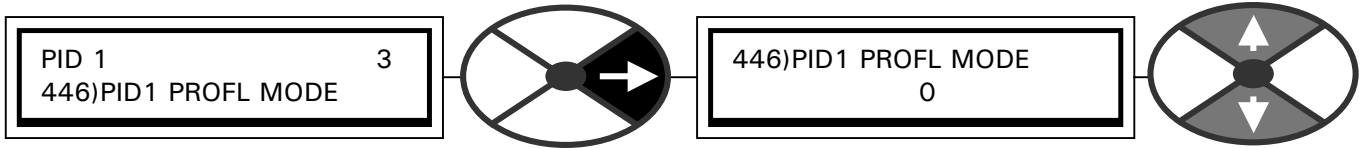

Allows selection of gain profile curve shape

PARAMETER	RANGE	DEFAULT	PIN
PID1 PROFL MODE	1 of 5 modes	0	446

Mode	Law of profile curve
0	Yaxis output = Yaxis MAX
1	Yaxis output = Linear change between MIN and MAX
2	Yaxis output = Square law change between MIN and MAX
3	Yaxis output = Cubic law change between MIN and MAX
4	Yaxis output = 4 <sup>th</sup> power law change between MIN and MAX

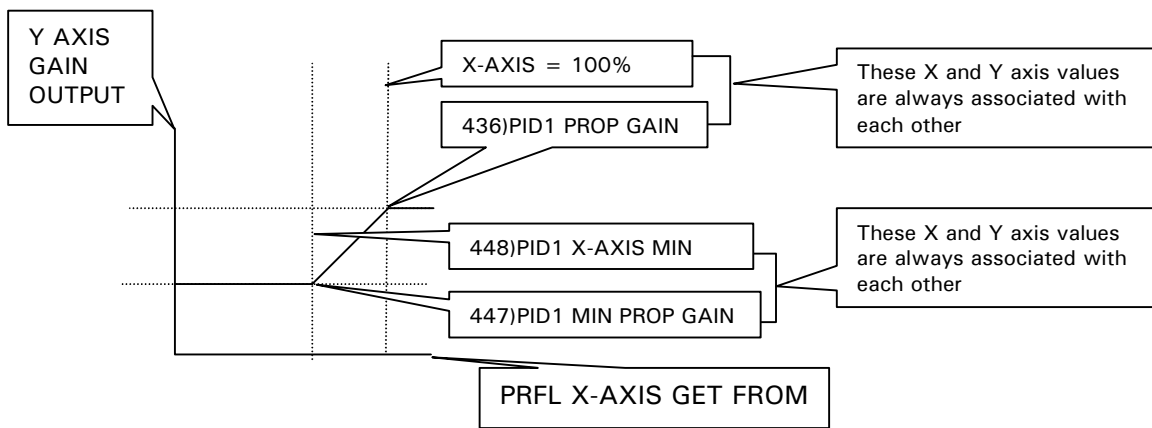

3.3.20 PID 1, 2 / PID minimum proportional gain PIN 447 / 470

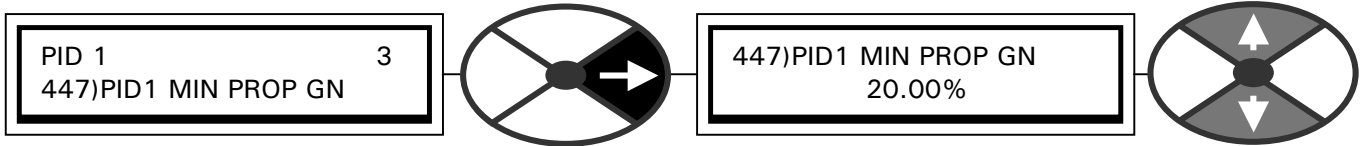

Sets the minimum value for the PID parameter profile output.

PARAMETER	RANGE	DEFAULT	PIN
PID1 MIN PROP GN	0.00 to 100.00%	20.00%	447

3.3.21 PID 1, 2 / PID Profile X axis minimum PIN 448 / 471

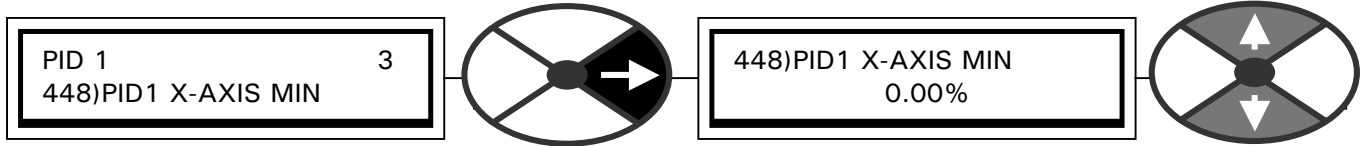

Sets the minimum value for the PID parameter profile X-AXIS.

PARAMETER	RANGE	DEFAULT	PIN
PID1 X-AXIS MIN	0.00 to 100.00%	0.00%	448

3.3.22 PID 1, 2 / PID Profile X axis GET FROM

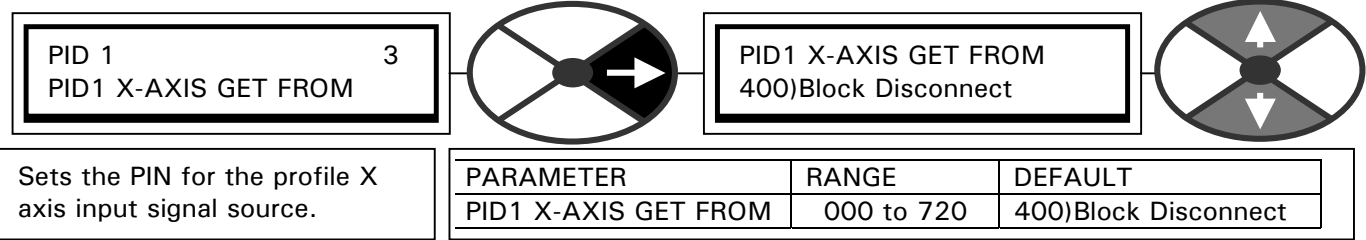

Sets the PIN for the profile X axis input signal source.

Note This GET FROM input has a built in rectifier and hence will accept bi-polar or unipolar inputs.

3.3.23 PID 1, 2 / PID Profiled prop gain output monitor PIN 449 / 472

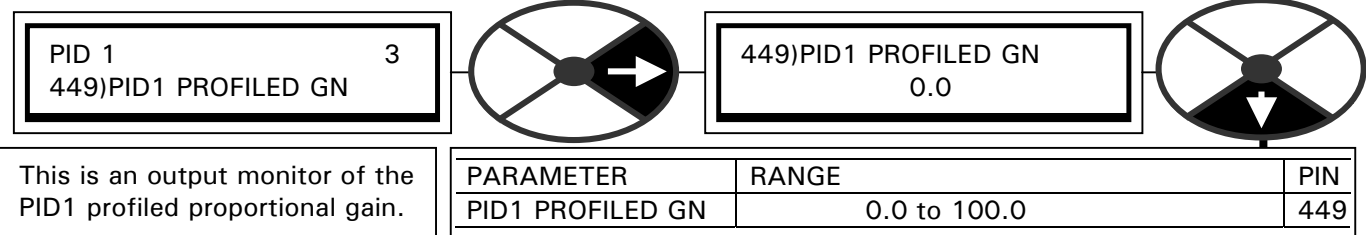

This is an output monitor of the PID1 profiled proportional gain.

This window has a branch hopping facility.

3.3.24 PID 1, 2 / PID clamp flag monitor PIN 450 / 473

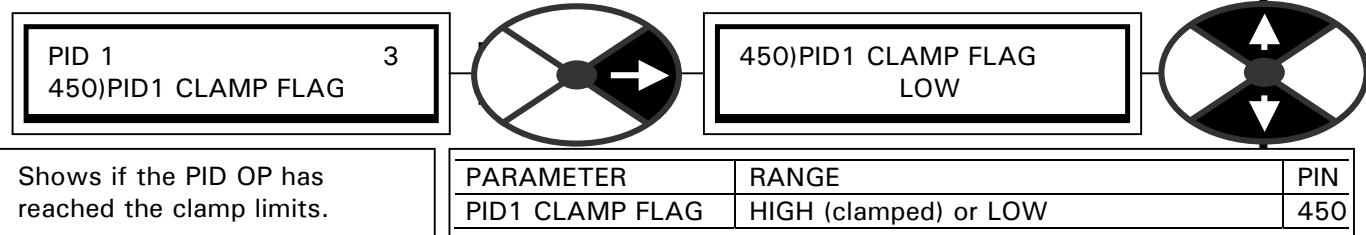

Shows if the PID OP has reached the clamp limits.

See 3.3.16 and 3.3.17 PID 1, 2 / PID negative clamp level PIN 444 / 467.

This window has a branch hopping facility.

3.3.25 PID 1, 2 / PID error value monitor PIN 451 / 474

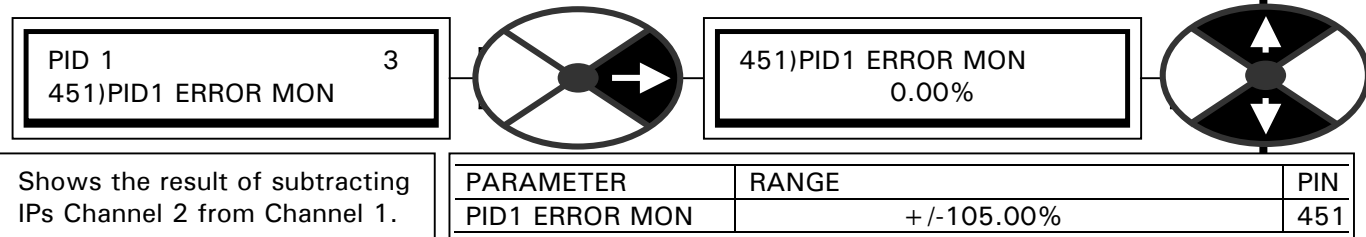

Shows the result of subtracting IPs Channel 2 from Channel 1.

Note. This error signal is internally clamped at +/-105.00%.

This window has a branch hopping facility to 3.3.2 PID 1, 2 / PID output monitor PIN 429 / 452.

### 3.4 APPLICATION BLOCKS / PARAMETER PROFILER

PINs used 475 to 481

APPLICATION BLOCKS	2
PARAMETER PROFILER	3

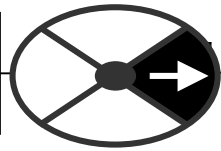

#### 3.4.1 PARAMETER PROFILER / Block diagram

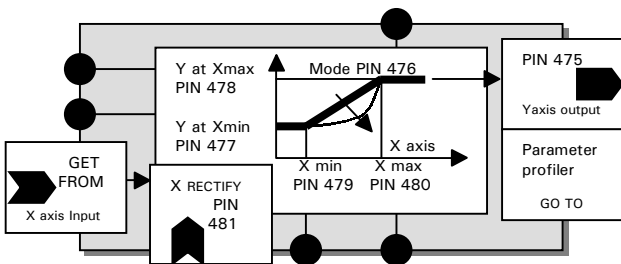

This block is used when it is desirable to modulate one parameter according to the magnitude of another. A typical example is changing the gain of a block as the error increases.

The block symbol shows the profiler working in the positive quadrant by using a rectified version of the input signal to indicate the position on the profile X axis. The related Y axis amplitude is then sent to the block output. Both axes are able to impose maximum and minimum levels to the profile translation. The profile curve is able to adopt several different modes.

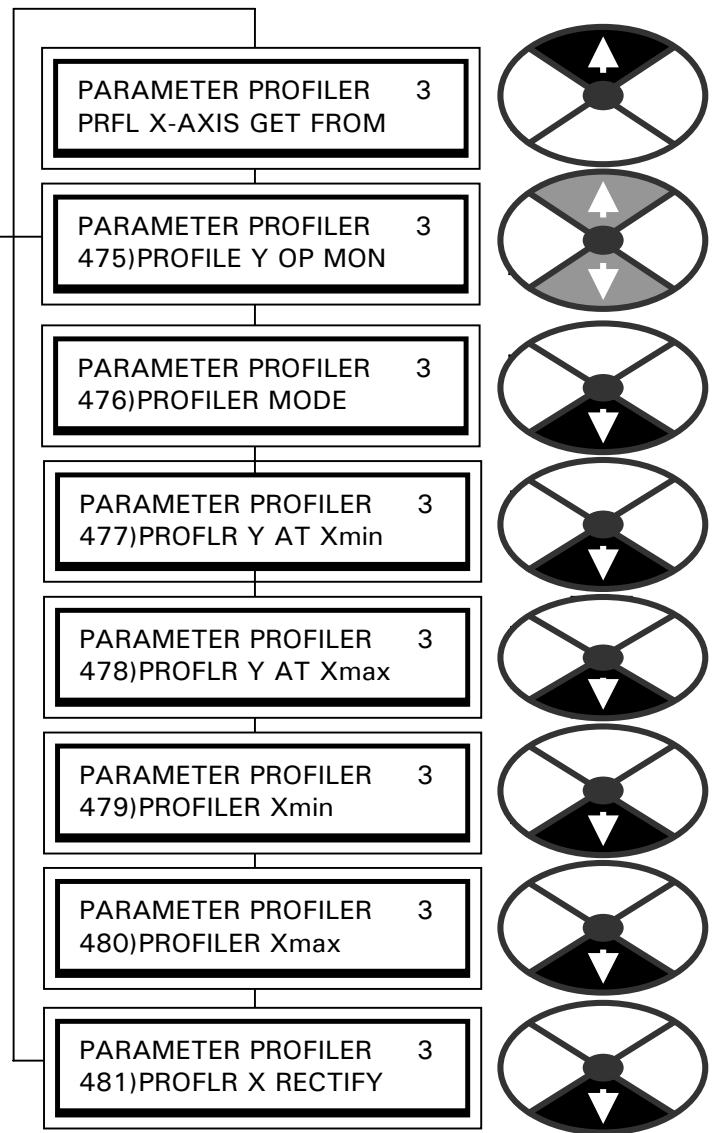

It is possible to use the block in up to 4 quadrants for specialist applications.

The input is connected by using the PRFL X-AXIS GET FROM window in this menu.

##### 3.4.1.1 Profile for Y increasing with X

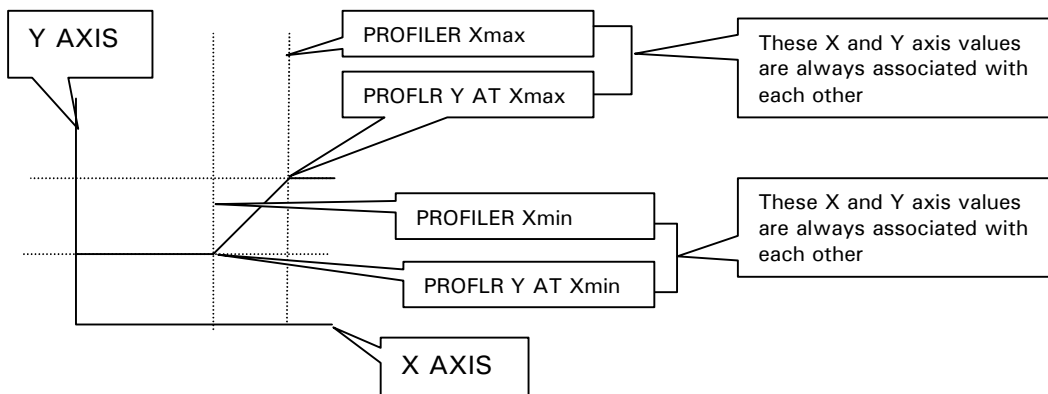

The graph shows the positive quadrant only.

It is useful to consider each pair of min values as a coordinate, and each pair of max values as a coordinate.

3.4.1.2 Profile for Y decreasing with X

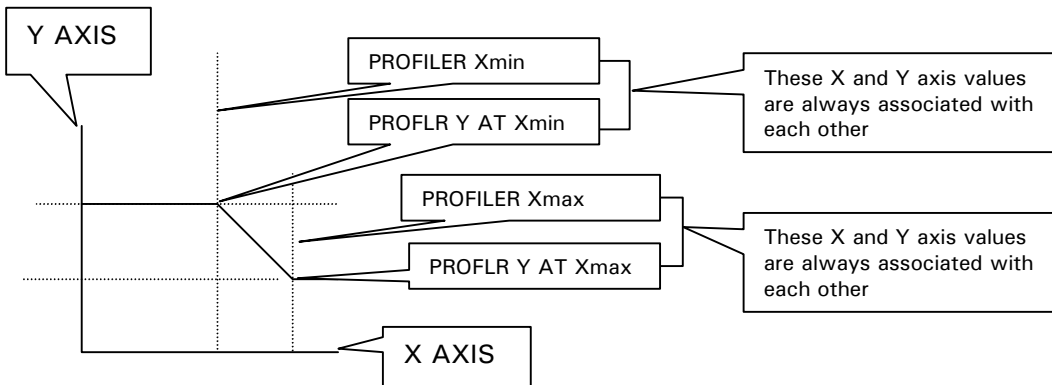

The graph shows the positive quadrant only. It is useful to consider each pair of min values as a coordinate, and each pair of max values as a coordinate.

3.4.1.3 Examples of general profiles

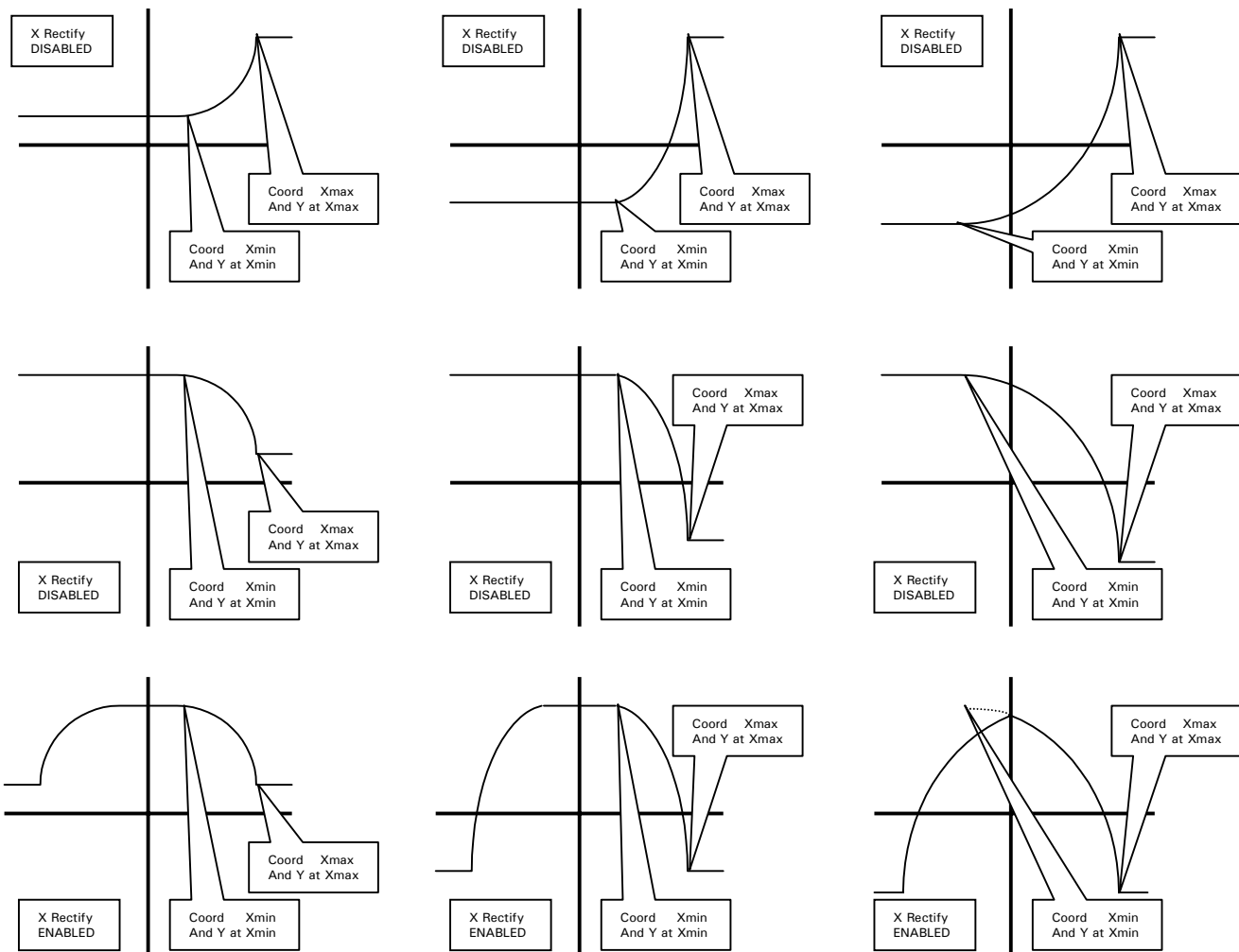

- 1) The above graphs show some of the possible profiles.
- 2) When using 2<sup>nd</sup>, 3<sup>rd</sup> or 4<sup>th</sup> order modes the curve always approaches the Xmin coordinate asymptotically.
- 3) If the value for Xmin is greater or equal to Xmax, then Y is constant and equal to PROFLR Y AT Xmax.
- 4) If the PROFILER MODE is set to 0 then Y is constant and equal to PROFLR Y AT Xmax.



3.4.2 PARAMETER PROFILER / Profile Y output monitor PIN 475

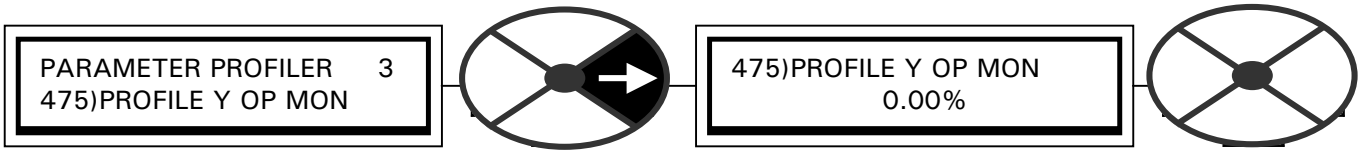

This is the final output monitor of the parameter profiler block.

PARAMETER	RANGE	DEFAULT	PIN
PROFILE Y OP MON	+/-300.00%	0.00%	475

3.4.3 PARAMETER PROFILER / Profiler mode PIN 476

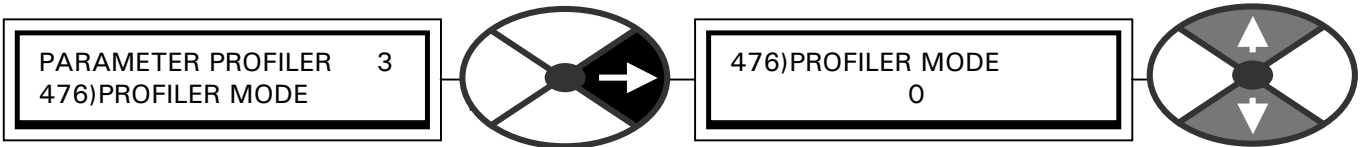

Sets the mode of the profile curve between **min** and **max**.

PARAMETER	RANGE	DEFAULT	PIN
PROFILER MODE	1 of 5 modes	0	476

Mode	Law of profile curve
0	Yaxis output = Y at Xmax
1	Yaxis output = Linear change between <b>min</b> coords and <b>max</b> coords
2	Yaxis output = Square law change between <b>min</b> coords and <b>max</b> coords
3	Yaxis output = Cubic law change between <b>min</b> coords and <b>max</b> coords
4	Yaxis output = 4 <sup>th</sup> power law change between <b>min</b> coords and <b>max</b> coords

3.4.4 PARAMETER PROFILER / Profile Y at Xmin PIN 477

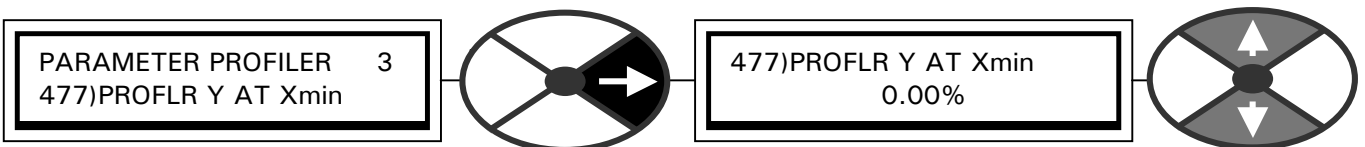

Sets the corresponding value for the Y axis at Xmin.

PARAMETER	RANGE	DEFAULT	PIN
PROFLR Y AT Xmin	+/-300.00%	0.00%	477

3.4.5 PARAMETER PROFILER / Profiler Y at Xmax PIN 478

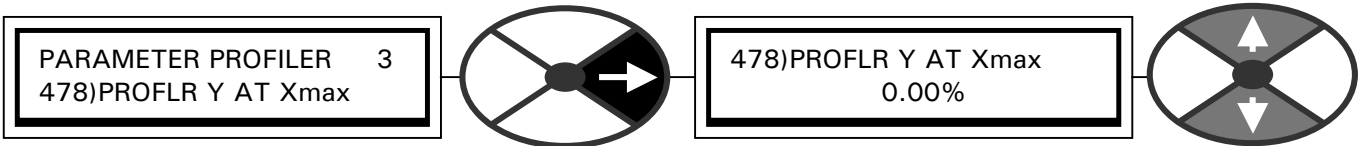

Sets the corresponding value for the Y axis at Xmax.

PARAMETER	RANGE	DEFAULT	PIN
PROFLR Y AT Xmax	+/-300.00%	100.00%	478

3.4.6 PARAMETER PROFILER / Profile X axis minimum PIN 479

PARAMETER PROFILER 3  
479)PROFILER Xmin

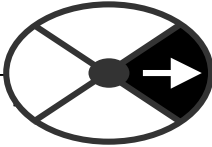

479)PROFILER Xmin  
0.00%

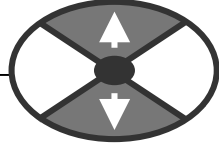

Sets the minimum value for the X axis input.

PARAMETER	RANGE	DEFAULT	PIN
PROFILER Xmin	+/-300.00%	0.00%	479

If the value for Xmin is greater or equal to Xmax, then Y is constant and equal to PROFLR Y AT Xmax.

3.4.7 PARAMETER PROFILER / Profile X axis maximum PIN 480

PARAMETER PROFILER 3  
480)PROFILER Xmax

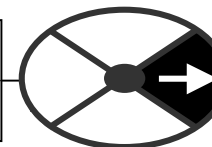

480)PROFILER Xmax  
100.00%

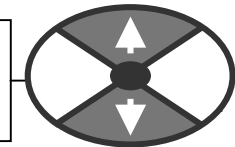

Sets the maximum value for the X axis input.

PARAMETER	RANGE	DEFAULT	PIN
PROFL X-AXIS MAX	+/-300.00%	100.00%	480

If the value for Xmin is greater or equal to Xmax, then Y is constant and equal to PROFLR Y AT Xmax.

3.4.8 PARAMETER PROFILER / Profile X axis rectify PIN 481

PARAMETER PROFILER 3  
481)PROFLR X RECTIFY

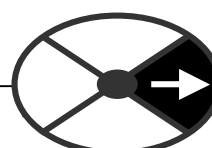

481)PROFLR X RECTIFY  
ENABLED

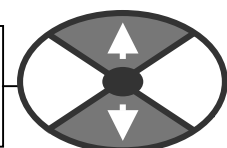

Enables the X axis input to be rectified prior to profiling.

PARAMETER	RANGE	DEFAULT	PIN
PROFLR X RECTIFY	ENABLED OR DISABLED	ENABLED	481

3.4.9 PARAMETER PROFILER / Profile X axis GET FROM

PARAMETER PROFILER 3  
PRFL X-AXIS GET FROM

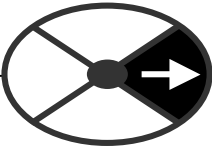

PRFL X-AXIS GET FROM  
400)Block Disconnect

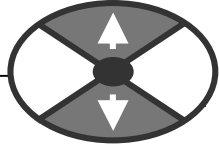

Sets the PIN for the profile X axis input signal source.

PARAMETER	RANGE	DEFAULT
PRFL X-AXIS GET FROM	000 to 720	400)Block Disconnect

### 3.5 APPLICATION BLOCKS / REEL DIAMETER CALC

PINs used 483 to 493

For a constant web speed the reel shaft slows down as the reel diameter increases. Dividing the web speed by the shaft speed gives the reel diameter.

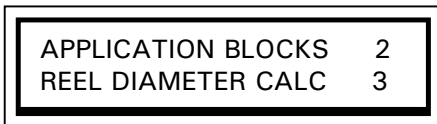

This block performs reel diameter calculation and provides a diameter output for control of web winding tension systems.

The diameter value can be independently preset to any value to allow seamless take up for winding or unwinding applications. There is provision made to suspend diameter calculation if the speed falls below a user preset threshold. The diameter can be programmed to be retained indefinitely during power loss if desired. A filter with adjustable time constant is included which will smooth the calculation output. The block provides a web break alarm flag output with adjustable threshold that compares the input and output of the smoothing filter.

With this measure of the reel diameter it is possible to control the torque of the reel shaft to give constant tension in the web. This method of tension control is an open loop technique, and relies on the system properties remaining constant over time.

Not all the torque at the shaft goes into web tension. Some of it is used to overcome losses in the mechanical system. These can be caused by:-

- Static or starting friction.
- Dynamic friction due to windage etc.
- The fixed inertia of the motor and transmission.
- The varying inertia of the increasing reel.

A torque compensation block (3.7 APPLICATION BLOCKS / TORQUE COMPENSATOR) is available to provide a compensatory signal which adds just sufficient torque to overcome the losses. For good results it is essential to keep the torque required for loss compensation as low as possible compared with that required to make tension. E. g. The torque required to overcome the losses are 10% of the torque required to provide the desired web tension. Then a drift of 25% in the losses results in a tension error of 2.5%. However if the torque required to overcome the losses is the same as the torque required to provide the desired web tension, then a drift of 25% in the losses results in a tension error of 25%. Also it will be much more difficult to estimate the absolute magnitude of the losses if they are large.

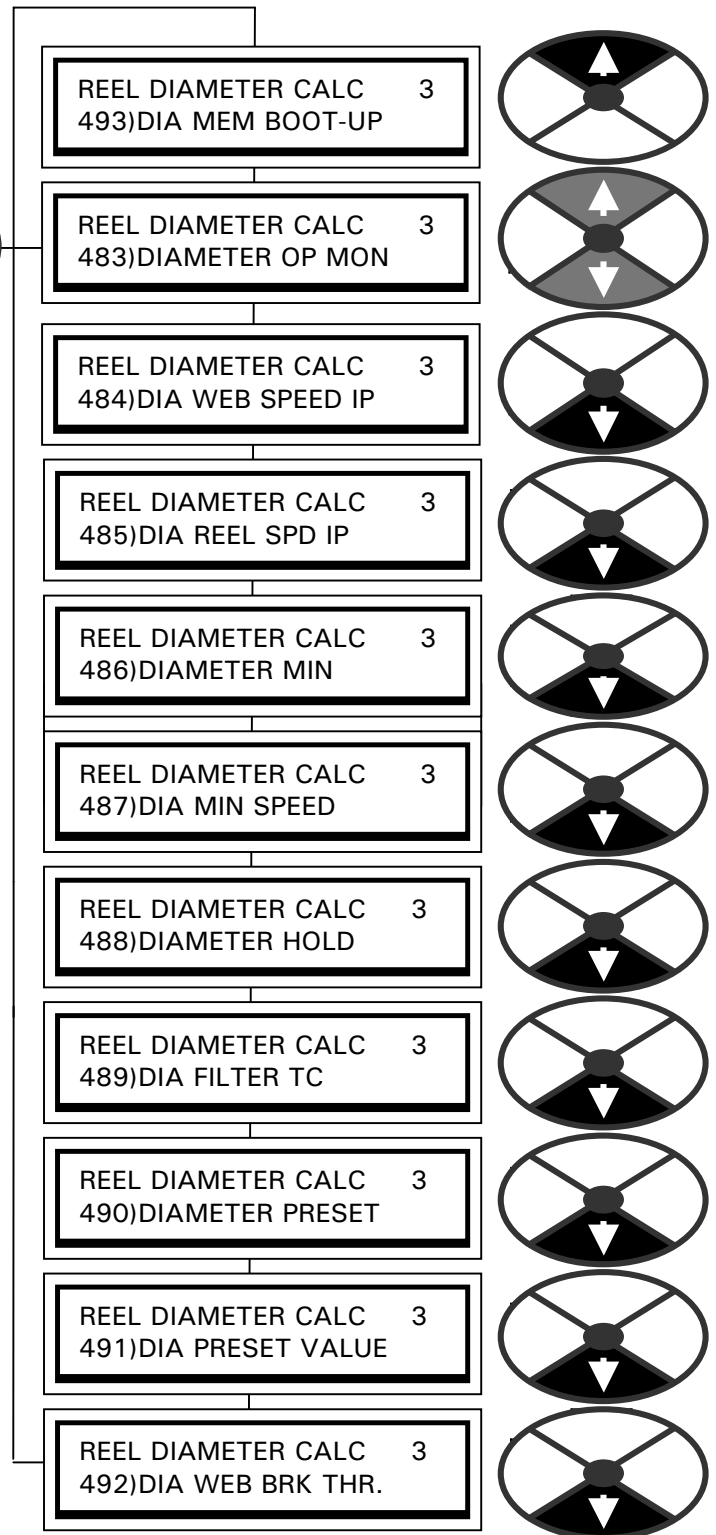

Some systems require the tension of the web to be tapered according to the reel diameter. This technique is used to prevent reel collapse or damage to delicate materials. A taper control block is available for this function. (3.6 APPLICATION BLOCKS / TAPER TENSION CALC)

If the diameter calculation is held then it is still possible to connect to a hidden PIN 697 which contains the unheld diameter calculation. Two other hidden PINs contain the rectified web and reel speeds

3.5.1 REEL DIAMETER CALC / Block diagram

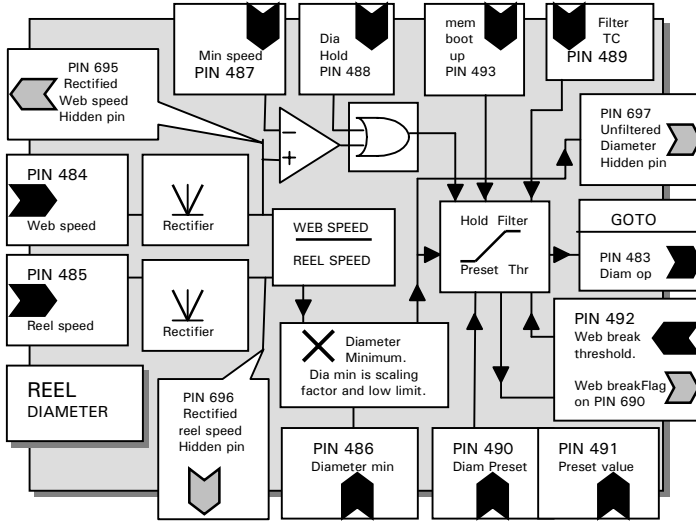

**Warning.** If due to the mechanical arrangement of the machine, it is impossible to achieve sufficiently low losses, then a closed loop system of tension control must be employed.

This could be by dancing arm methods or a tension transducer loadcell feedback system.

**Note.** This block is usually used in conjunction with the TAPER TENSION CALC and TORQUE COMPENSATOR blocks. In this case the diameter result is automatically connected to these blocks via internal software connections.

Hence the GOTO of this block must be connected to a staging post, for example, in order to activate the block.

See 3.8 Centre winding block arrangement.

3.5.2 REEL DIAMETER CALC / Diameter output monitor PIN 483

REEL DIAMETER CALC 3  
483)DIAMETER OP MON

483)DIAMETER OP MON  
0.00%

This is the output result of the diameter calculator.

PARAMETER	RANGE	DEFAULT	PIN
DIAMETER OP MON	0.00 to +100.00%	0.00%	483

3.5.3 REEL DIAMETER CALC / Web speed input PIN 484

REEL DIAMETER CALC 3  
484)DIA WEB SPEED IP

484)DIA WEB SPEED IP  
0.00%

Sets the input value, prior to rectifying, for the WEB speed.

PARAMETER	RANGE	DEFAULT	PIN
DIA WEB SPEED IP	+/-105.00%	0.00%	484

3.5.4 REEL DIAMETER CALC / Reel speed input PIN 485

REEL DIAMETER CALC 3  
485)DIA REEL SPD IP

485)DIA REEL SPD IP  
0.00%

Sets the input value, prior to rectifying, for the reel speed.

PARAMETER	RANGE	DEFAULT	PIN
DIA REEL SPD IP	+/-105.00%	0.00%	485

3.5.5 REEL DIAMETER CALC / Minimum diameter input PIN 486

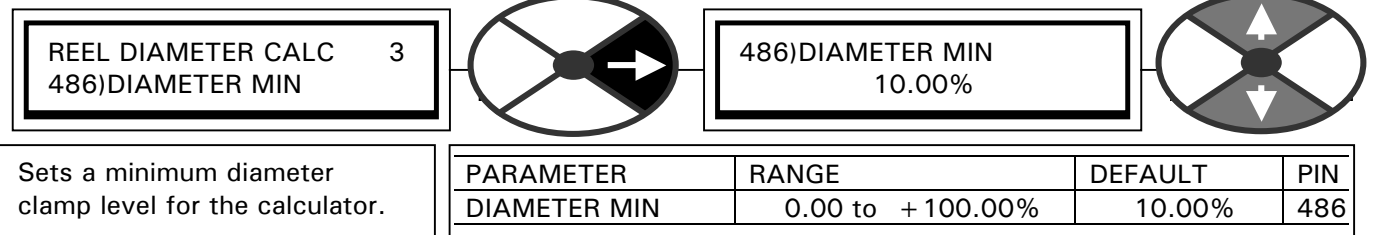

This value is also used as a scaling factor for the diameter calculation.  $Result = (Web/Reel) \times (Dia\ min)$

3.5.6 REEL DIAMETER CALC / Diameter calculation min speed PIN 487

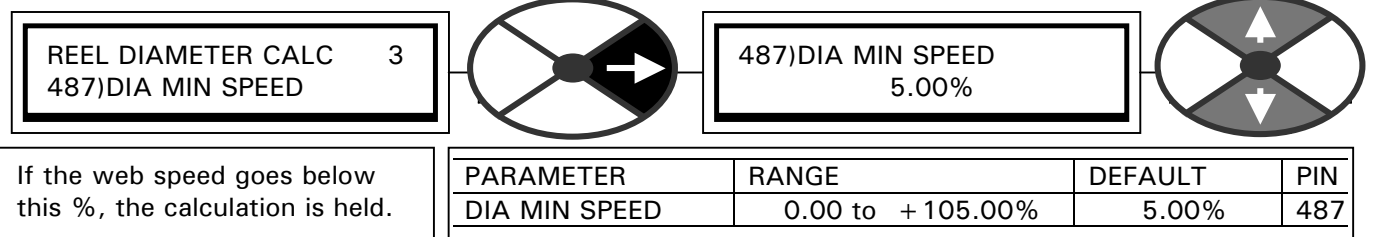

3.5.7 REEL DIAMETER CALC / Diameter hold enable PIN 488

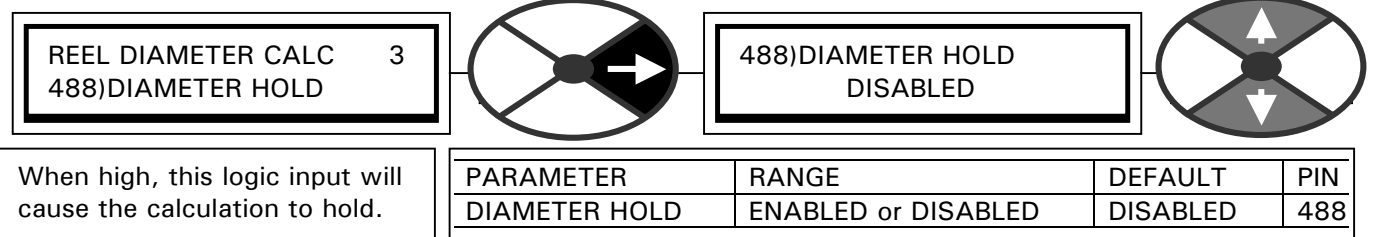

3.5.8 REEL DIAMETER CALC / Diameter filter time constant PIN 489

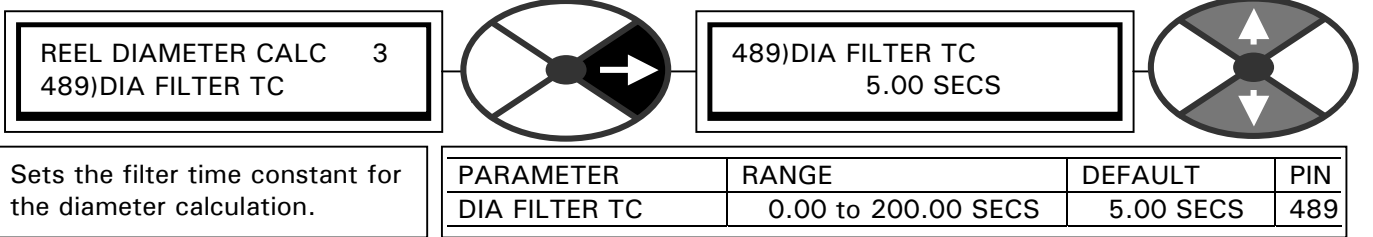

This value applies a filter to the output to remove small transients in the raw calculation. The difference between the input and output of the filter also provides a comparison measurement for the web break detector. See 3.5.11 REEL DIAMETER CALC / Diameter web break threshold PIN 492.

## 3.5.9 REEL DIAMETER CALC / Diameter preset enable PIN 490

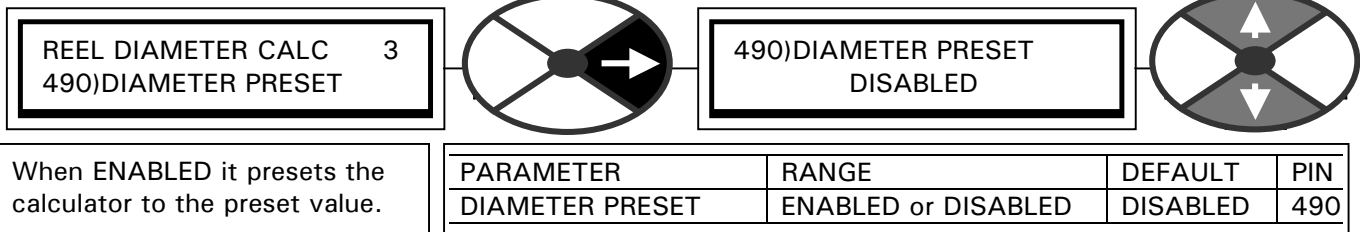

## 3.5.10 REEL DIAMETER CALC / Diameter preset value PIN 491

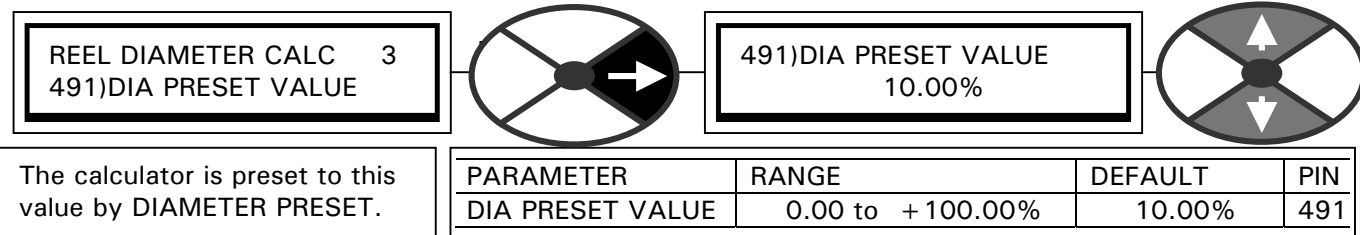

## 3.5.11 REEL DIAMETER CALC / Diameter web break threshold PIN 492

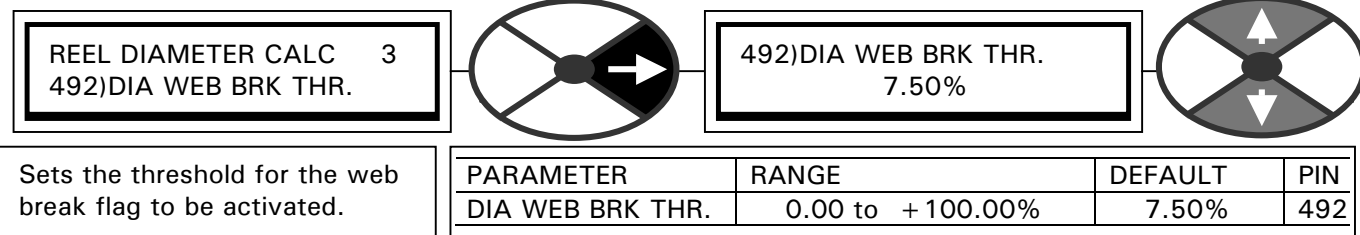

A break in the web will cause a sudden change in the diameter calculation due to the breakdown of the speed relationship. Hence if the raw calculation value changes at a rate that causes it to differ from the filtered calculation result by more than this threshold value, then the web break flag on hidden PIN 690 will be set high. See 3.5.8 REEL DIAMETER CALC / Diameter filter time constant PIN 489.

Note. This flag will also go high if the calculator output is preset to a value which differs from the calculated value, (derived from the prevailing web and reel speeds), by more than the threshold.

## 3.5.12 REEL DIAMETER CALC / Diameter memory boot up PIN 493

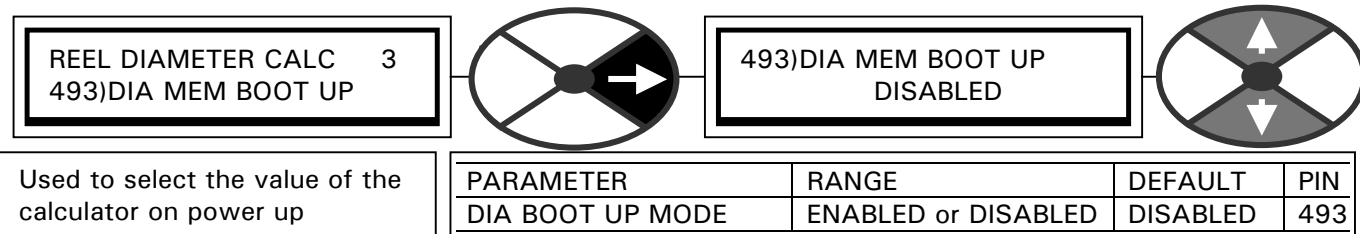

This may be used to retain the calculator value in the event of a power loss.

- 1) DISABLED Used to set the value of the calculator on control supply power up to the MIN DIAMETER.
- 2) ENABLED Used to retain the current value of the calculator during control supply power off.

### 3.6 APPLICATION BLOCKS / TAPER TENSION CALC

PINs used 494 to 499

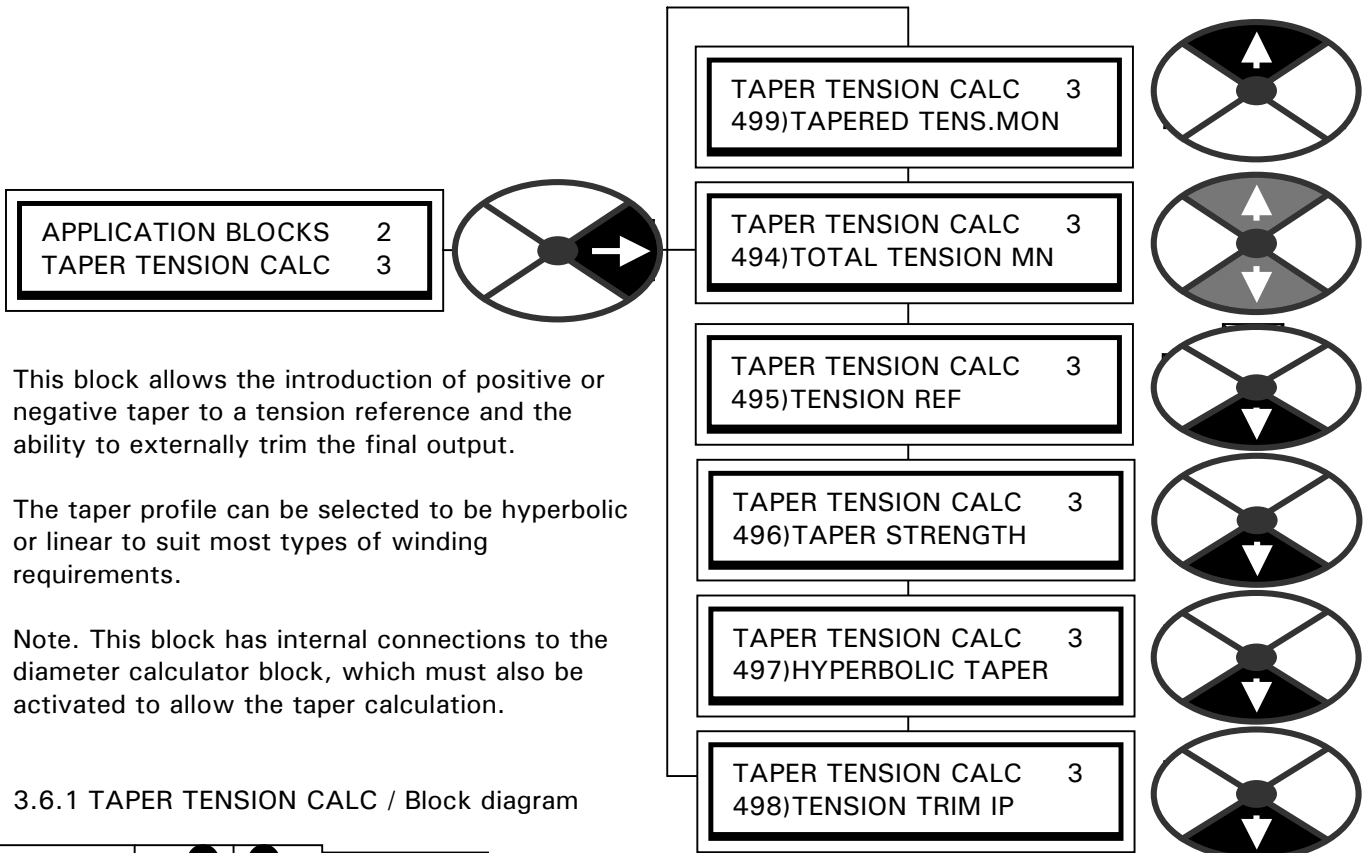

This block allows the introduction of positive or negative taper to a tension reference and the ability to externally trim the final output.

The taper profile can be selected to be hyperbolic or linear to suit most types of winding requirements.

Note. This block has internal connections to the diameter calculator block, which must also be activated to allow the taper calculation.

#### 3.6.1 TAPER TENSION CALC / Block diagram

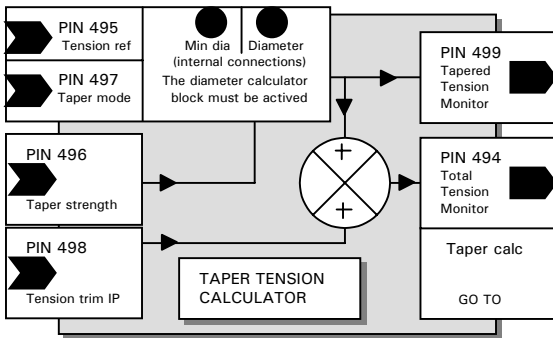

##### 3.6.1.1 Linear taper equation

$$\text{Tapered tension\%} = (\text{Tension ref\%} / 100\%) \times (100\% - (\text{Dia\%} - \text{Min dia\%}) \times \text{Taper strength\%} / 100\%)$$

Example. Min diameter 10%, Diameter 50%, Tension ref 70%, Taper strength - 40%.

$$\begin{aligned} \text{Tapered tension\%} &= (70\% / 100\%) \times (100\% - (50\% - 10\%) \times -40\% / 100\%) \\ &= 0.7 \times (100\% - (40\% \times -0.4)) \\ &= 0.7 \times (100\% - (-16\%)) \\ &= 0.7 \times 116\% \\ &= 81.20\% \end{aligned}$$

##### 3.6.1.2 Hyperbolic taper equation

$$\text{Tapered tension\%} = (\text{Tension ref\%} / 100\%) \times (100\% - (\text{Dia\%} - \text{Min dia\%}) \times \text{Taper strength\%} / \text{Dia\%})$$

3.6.1.3 Taper graphs showing tension versus diameter

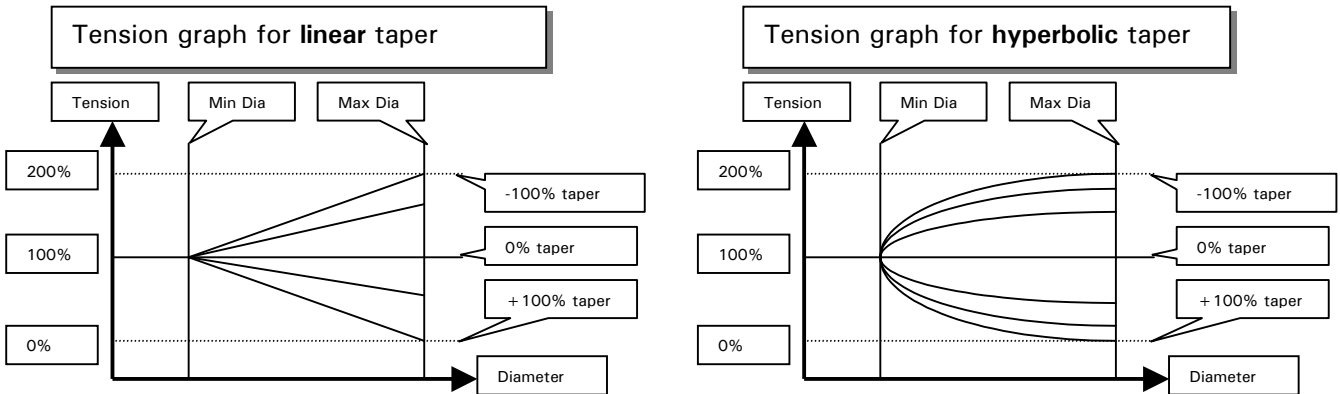

3.6.1.4 Taper graphs showing torque versus diameter

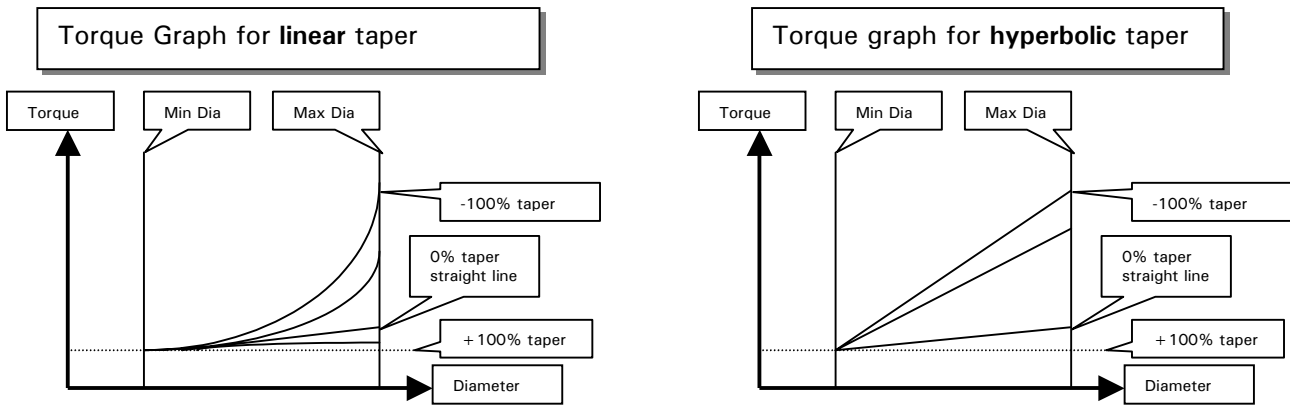

3.6.2 TAPER TENSION CALC / Total tension OP monitor PIN 494

TAPER TENSION CALC 3  
494)TOTAL TENSION MN

494)TOTAL TENSION MN  
0.00%

This is the total output of the taper tension calculator.

PARAMETER	RANGE	PIN
TOTAL TENSION MN	+/-100.00%	494

This has a branch hopping facility to 3.6.7 TAPER TENSION CALC / Tapered tension monitor PIN 499.

3.6.3 TAPER TENSION CALC / Tension reference PIN 495

TAPER TENSION CALC 3  
495)TENSION REF

495)TENSION REF  
0.00%

This is the tension reference for the taper tension calculator

PARAMETER	RANGE	DEFAULT	PIN
TENSION REF	0.00 to +100.00%	0.00%	495



3.6.4 TAPER TENSION CALC / Taper strength input PIN 496

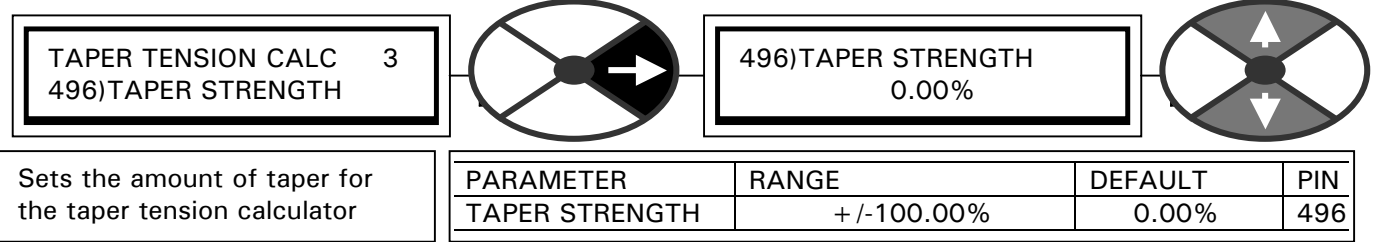

Note. +100.00% taper progressively reduces the tension to zero at full diameter.

0.00% taper gives constant tension over the entire diameter range.

-100.00% taper progressively increases the tension to 200.00% at full diameter.

The taper may be linear or hyperbolic. See 3.6.5 TAPER TENSION CALC / Hyperbolic taper enable PIN 497.

3.6.5 TAPER TENSION CALC / Hyperbolic taper enable PIN 497

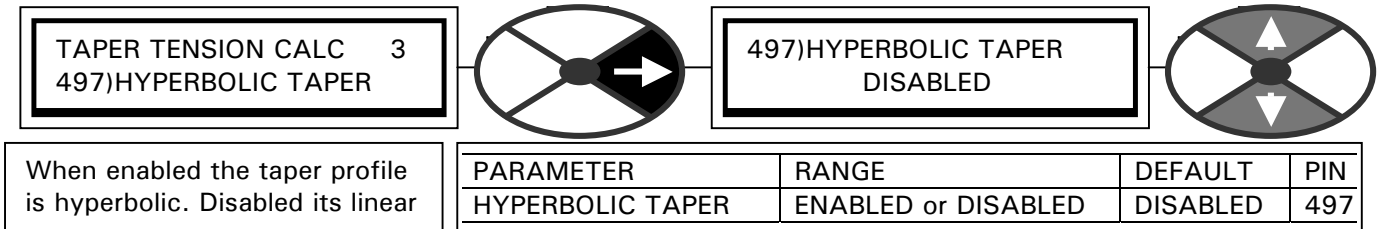

See 3.6.4 TAPER TENSION CALC / Taper strength input PIN 496.

3.6.6 TAPER TENSION CALC / Tension trim input PIN 498

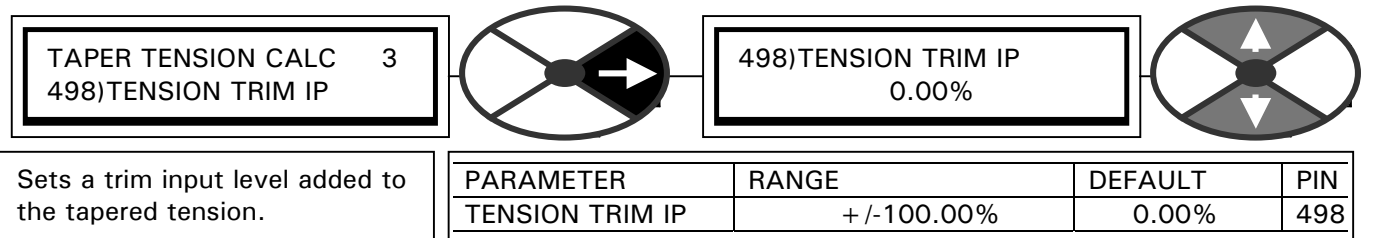

3.6.7 TAPER TENSION CALC / Tapered tension monitor PIN 499

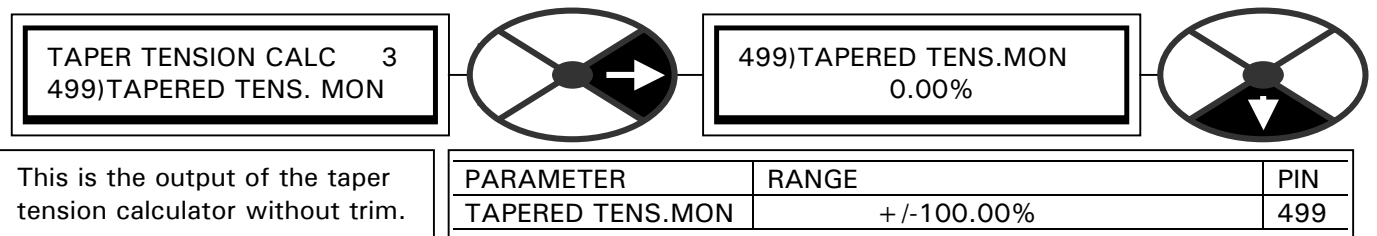

This has a branch hopping facility to 3.6.2 TAPER TENSION CALC / Total tension OP monitor PIN 494

### 3.7 APPLICATION BLOCKS / TORQUE COMPENSATOR

PINs used 500 to 520

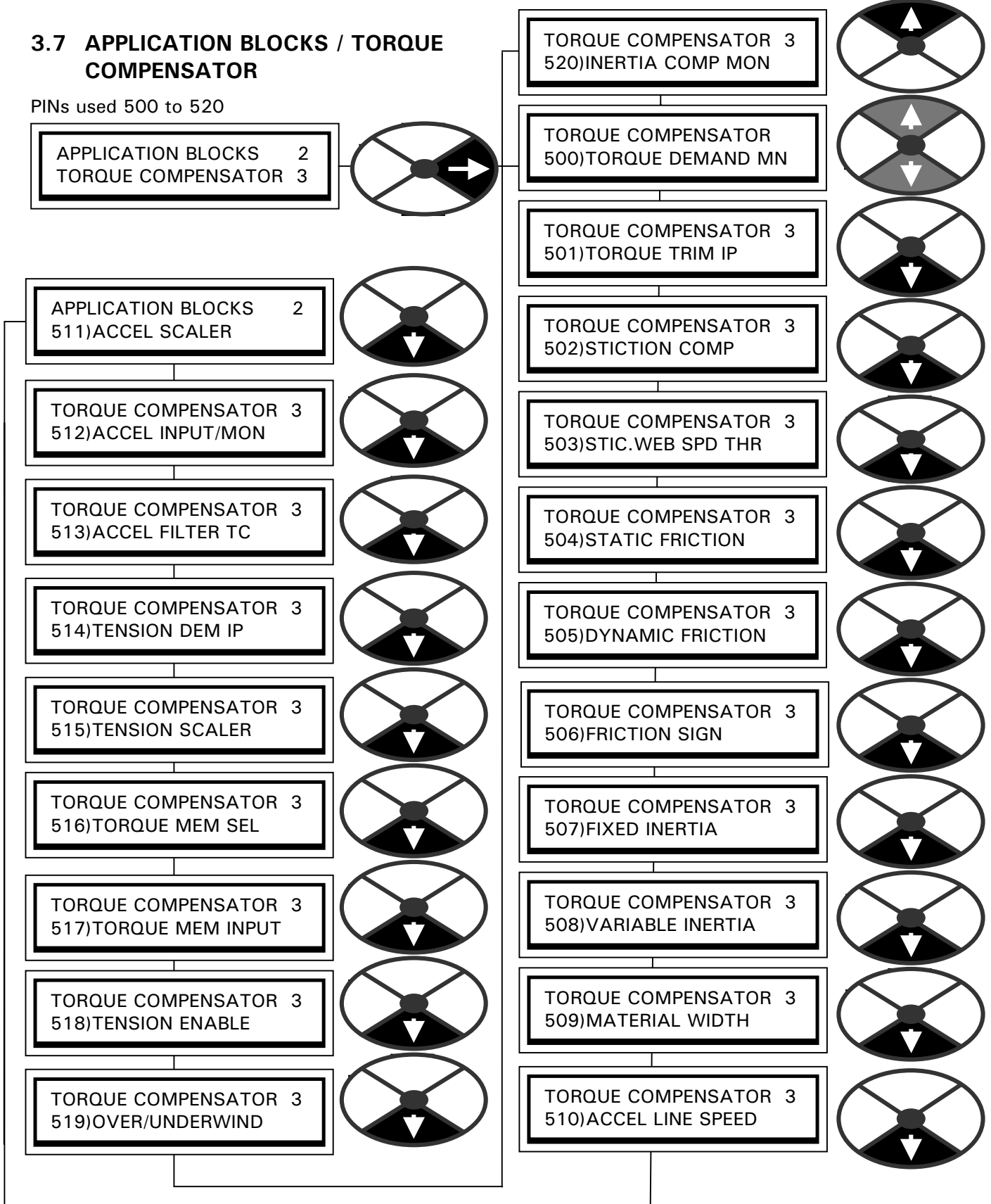

This block is used to add loss compensation to the tension demand signal generated by the TAPER TENSION CALC block. The result is steered to the positive and negative (if required) current limits of the target reel drive to provide a torque clamp which will give the correct tension. The losses in the winding system are friction and inertia. (To connect a block output GOTO to an analogue output terminal GETFROM:- The block GOTO must first be connected to a staging post, and then the analogue output GETFROM used to acquire the value from the staging post. This is because GOTOs and GETFROMs cannot be directly connected to each other). See section 13.2 in the main manual for the PL/X.

When winding, the drive system relies on arranging the speed loop to saturate. This means that under all running conditions the speed demand remains unsatisfied, and hence is always asking for more current than the clamps will allow. Hence the current is operating at the limit determined by the torque compensator. The speed loop saturation may be accomplished by adding an offset to the normal speed demand of the target reel drive.

**Friction.** The block provides compensation for stiction, static friction and dynamic friction. Stiction compensation is applied only if the web speed exceeds its programmed threshold (e. g. 5%) and the reel speed remains below 2%. This compensation is used to get the system moving. Static friction compensation is applied at a constant level throughout the speed range. Dynamic friction compensation is applied throughout the speed range and linearly increases with speed.

**Inertia.** When accelerating positively or negatively (decelerating), torque is required to overcome the mechanical inertia of the total load. Without compensation this torque is no longer available to provide tension. Hence to control the tension more accurately the block provides compensation for both fixed and variable inertia. The fixed inertia compensation is used to accelerate all fixed mass components of the system (e. g. motor, gearbox, reel former etc.). The variable inertia compensation is used to accelerate the process material, the mass of which is changing as the reel diameter changes. There is also provision for compensating for different material widths.

The compensation factors may be found by pure calculation, or empirically. The descriptions here outline empirical methods that may be utilised using only a reel drive, and a full and empty reel.

3.7.1 TORQUE COMPENSATOR / Block diagram

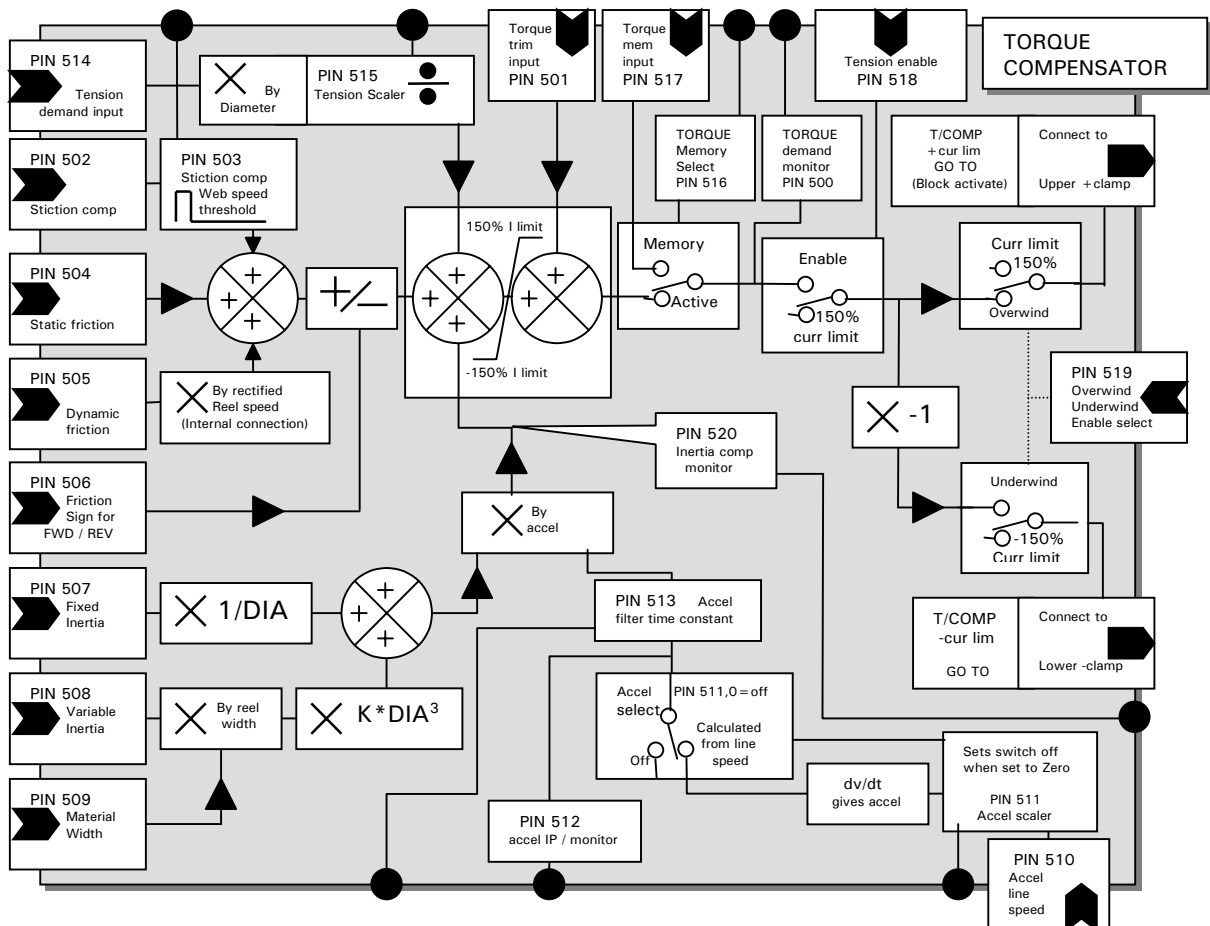

3.7.2 TORQUE COMPENSATOR / Torque demand monitor PIN 500

TORQUE COMPENSATOR 3  
500)TORQUE DEMAND MN

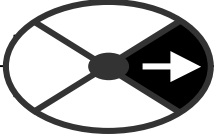

500)TORQUE DEMAND MN  
0.00%

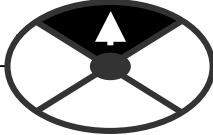

Allows the torque demand reference to be monitored.

PARAMETER	RANGE	DEFAULT	PIN
TORQUE DEMAND MN	+/-300.00%	0.00%	500

The torque demand reference is the sum of all the compensation components and the scaled tension demand. This has a branch hopping facility to 3.7.22 TORQUE COMPENSATOR / Inertia comp monitor PIN 520.

3.7.3 TORQUE COMPENSATOR / Torque trim input PIN 501

TORQUE COMPENSATOR 3  
501)TORQUE TRIM IP

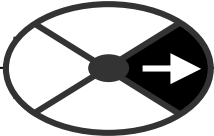

501)TORQUE TRIM IP  
0.00%

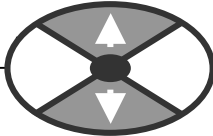

Allows a torque trim input to be added to the compensation.

PARAMETER	RANGE	DEFAULT	PIN
TORQUE TRIM IP	+/-150.00%	0.00%	501

3.7.4 TORQUE COMPENSATOR / Stiction compensation PIN 502

TORQUE COMPENSATOR 3  
502)STICTION COMP

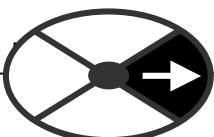

502)STICTION COMP  
0.00%

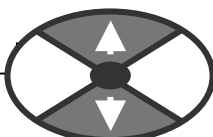

Sets the level of compensation required to overcome stiction.

PARAMETER	RANGE	DEFAULT	PIN
STICTION COMP	+/-300.00%	0.00%	502

See 3.7.5 TORQUE COMPENSATOR / Stiction web speed threshold PIN 503.

3.7.5 TORQUE COMPENSATOR / Stiction web speed threshold PIN 503

TORQUE COMPENSATOR 3  
503)STIC.WEB SPD THR

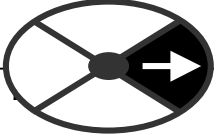

503)STIC.WEB SPD THR  
5.00%

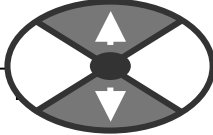

Sets the WEB speed above which stiction comp occurs.

PARAMETER	RANGE	DEFAULT	PIN
STIC.WEB SPD THR	0.00 to 10.00%	5.00%	503

Some systems require extra torque to overcome starting friction. This level must be set to ensure the reel motor starts rotating. The system will add the compensation set in 3.7.4 TORQUE COMPENSATOR / Stiction compensation PIN 502, when the web speed reference is greater than the threshold AND the reel speed feedback is less than 2.00%. Hence the compensation is only active during the stiction phase, and will not be permanently applied at zero web speed reference. The threshold is not signed and is applied to both directions of rotation. A value of 5.00% is suggested as a starting point.

3.7.6 TORQUE COMPENSATOR / Static friction compensation PIN 504

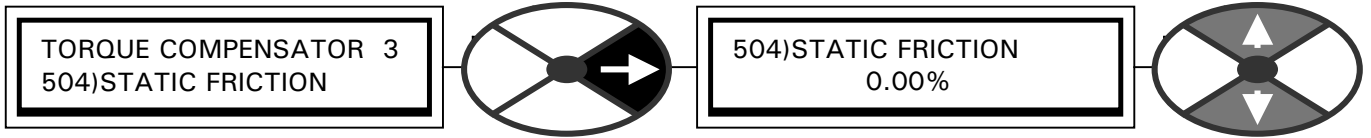

Sets the compensation required to overcome static friction.

PARAMETER	RANGE	DEFAULT	PIN
STATIC FRICTION	+/-300.00%	0.00%	504

This compensation is applied at a constant level throughout the speed range. With an empty reel running at 10% speed, observe the ARM CUR %. Enter the monitored value here.

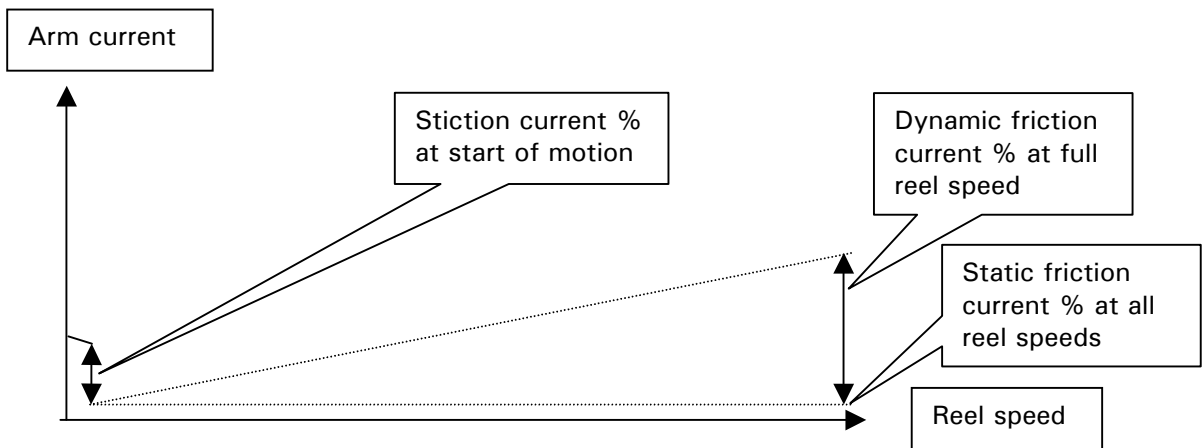

3.7.7 TORQUE COMPENSATOR / Dynamic friction compensation PIN 505

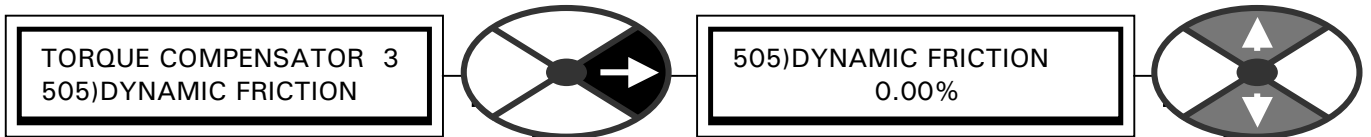

Compensation factor required to overcome dynamic friction.

PARAMETER	RANGE	DEFAULT	PIN
DYNAMIC FRICTION	+/-300.00%	0.00%	505

This compensation is applied at a level proportional to speed. With an empty reel running at 100% speed, observe the ARM CUR %. Enter the difference between the monitored value and 504)STATIC FRICTION. The block automatically adjusts the compensation by scaling it according to web speed.

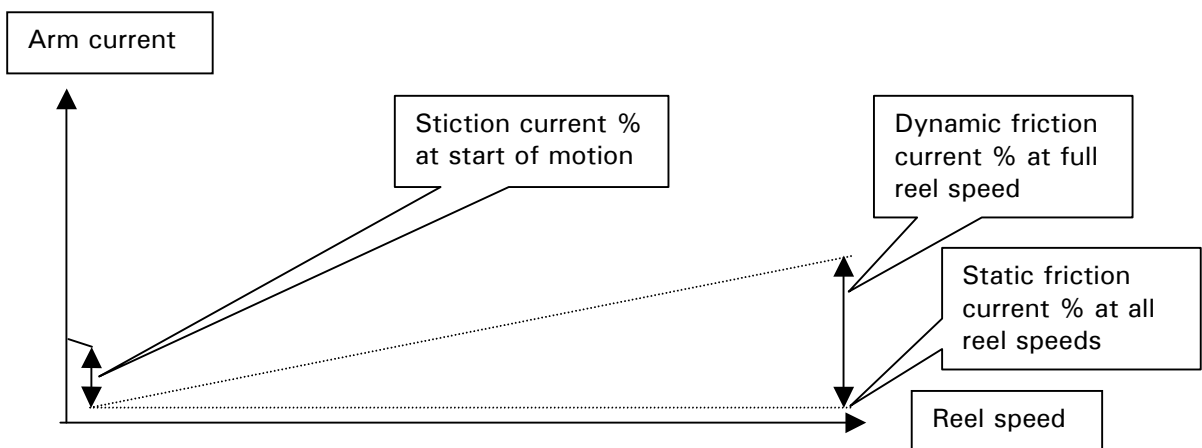

## 3.7.8 TORQUE COMPENSATOR / Friction sign PIN 506

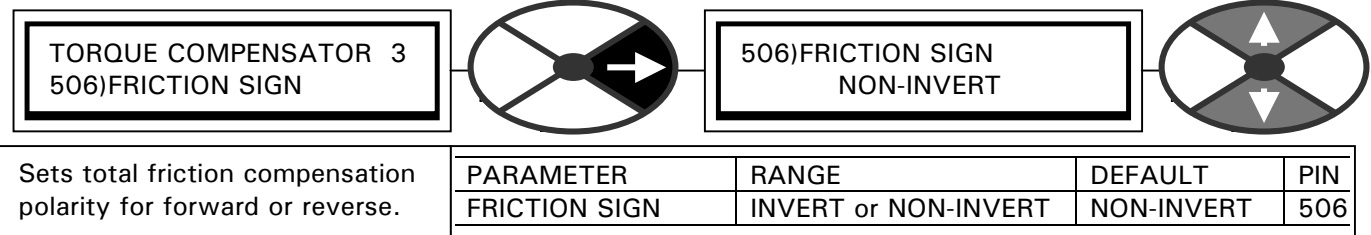

## 3.7.9 TORQUE COMPENSATOR / Fixed mass inertia PIN 507

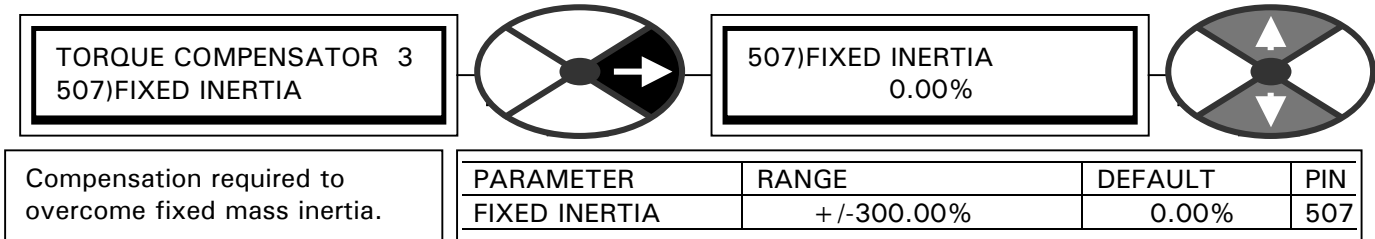

The compensation applied depends on reel diameter. The diameter calculator block must be activated in order for the diameter value to be acquired by this block.

The gain of this input is proportional to  $1/DIA$ . It is unity for minimum diameter and  $1/(\text{build up ratio})$  at maximum diameter.

To arrive at a suitable value to enter here you must perform a measurement of armature current with a separate empty reel running in speed control mode. First reprogram the reel drive speed ramp to the same ramp time as the web speed. Then set the speed to a constant 95% and note ARM CUR %. Increase the speed ref to 100%, while the reel is ramping up to the new speed measure the increased ARM CUR %. The **change** is the current% required to accelerate the fixed mass to the new speed at the normal maximum acceleration rate. Enter this change in current% in the FIXED INERTIA window.

If differing reel core sizes or masses are to be used, the fixed mass inertia value must be determined and then used for each reel core for complete accuracy.

The fixed inertia compensation has the greatest influence on tension accuracy for empty reels. In this case the speeds are higher and the ratio of fixed mass to variable mass is also higher. Hence for good results it is important to make accurate measurements to determine the compensation.

## 3.7.10 TORQUE COMPENSATOR / Variable mass inertia PIN 508

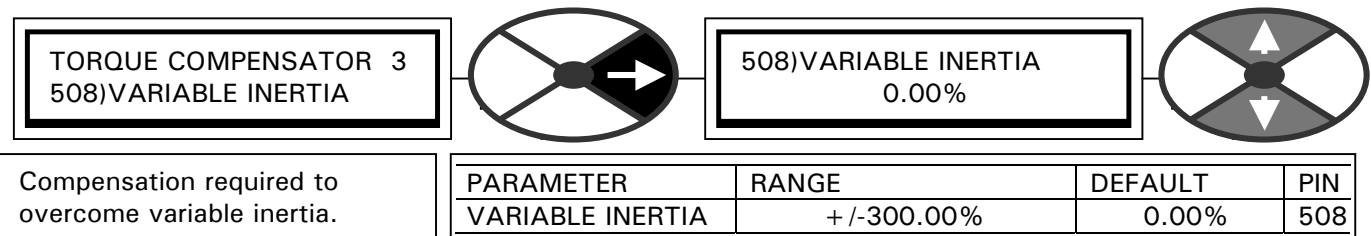

The compensation applied depends on reel diameter. The diameter calculator block must be activated in order for the diameter value to be acquired by this block.

The gain curve of this input is proportional to  $DIA^3$ . It is zero at minimum diameter and unity for maximum diameter. To arrive at a suitable value to enter here you must perform a measurement of armature current with a separate **full** reel running in speed control mode. The purpose of this experiment is to simulate the

condition of unity gain to this input and measure the torque required to accelerate the mass. This condition occurs at maximum diameter and hence minimum reel speed. First calculate the build up ratio. E. g. If your core diameter is 0.1 metre, and the full reel diameter is 0.5 metre, then the build up ratio is 5.

1) Then reprogram the reel drive speed ramp to a new longer ramp time as follows  
 New ramp time = the web speed ramp time **X** the build up ratio.

E. g. For a web speed ramp time of 10 secs and a build up ratio of 5. Adjust the reel speed ramp time to 50 secs for the duration of the experiment. Remember to return the reel speed ramp time to the original setting after the reading has been completed.

2) Set the speed of the reel drive to 100% / Build up ratio. (in this example this results in a 20% speed)

Then, increase the speed reference by 5%. Note the **change** in ARM CUR % whilst the reel of material is accelerating. Make a note of this value and then subtract an amount equal to 507)FIXED INERTIA, and the result represents the current% required to accelerate the mass of the material. Enter this value.

3.7.11 TORQUE COMPENSATOR / Material width PIN 509

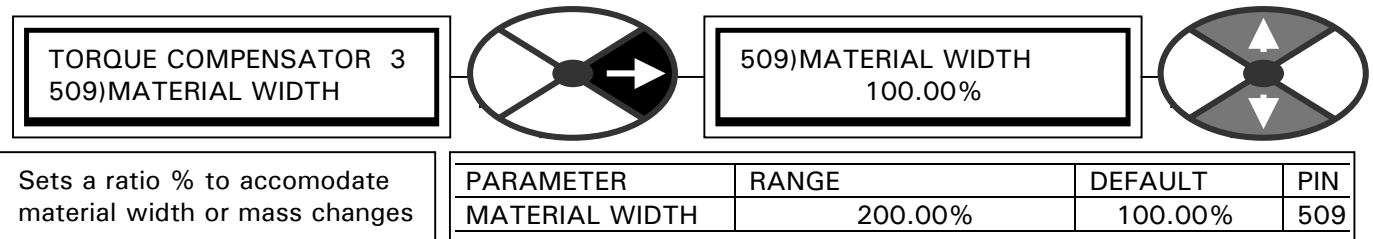

The material used during empirical measurement of inertia compensation currents is the 100% width/mass.

E. g. For material twice as wide as the measurement material this value should be set to 200.00%  
 For material of a specific gravity which is 80% of the measurement material, set the value to 80.00%.  
 For material of a specific gravity which is 80% of the measurement material, and twice as wide, set the value to 160.00%.

Note. The formula used by the block assumes an air core. The mass of the reel core is accomodated in the value for fixed mass inertia compensation. If the reel mass changes aswell as the material, then both FIXED INERTIA and MATERIAL WIDTH parameters will need adjusting.

3.7.12 TORQUE COMPENSATOR / Accel line speed input PIN 510

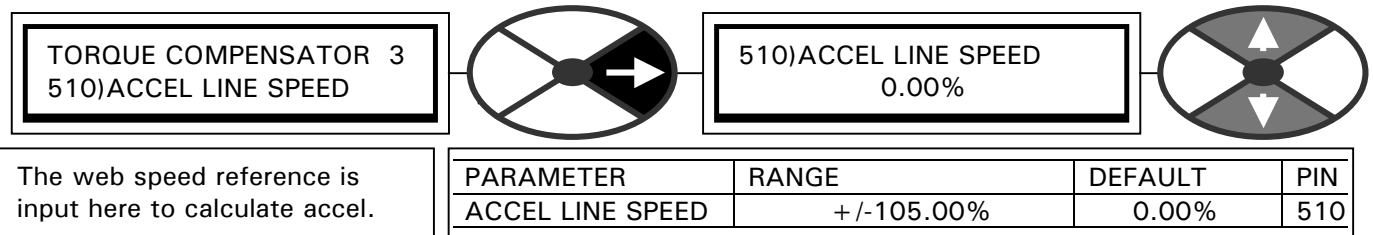

The acceleration of the system is required in order to calculate the total inertia compensation. There are two ways of arriving at a value for acceleration.

- 1) Input the acceleration value directly from an external source to PIN 512.
- 2) Let the block calculate the value by differentiating the line or web speed which is input to PIN 510.

When using method 2 a line or web speed reference is input. Note. The line speed reference will usually come from an external source via an analogue input terminal.

The input speed is scaled by PIN 511)ACCEL SCALER.

Note. If PIN 511)ACCEL SCALER is set to 0.00 then an internal switch is opened to allow 512)ACCEL INPUT/MON to become an input. Otherwise it remains a monitor of the calculated accel.

The resulting value on 512)ACCEL INPUT/MON should be arranged to be 100.00% for maximum acceleration by either method.

3.7.13 TORQUE COMPENSATOR / Accel scaler PIN 511

TORQUE COMPENSATOR 3  
511)ACCEL SCALER

511)ACCEL SCALER  
10.00

Sets the scaling factor to normalise the accel calculation.

PARAMETER	RANGE	DEFAULT	PIN
ACCEL SCALER	+/-100.00	10.00	511

Typically set this value to equal the 100% ramp time. E.g. Total ramp time equal 10 secs. Set to 10.00.

See 3.7.12 TORQUE COMPENSATOR / Accel line speed input PIN 510

Note. If PIN 511)ACCEL SCALER is set to 0.00 then an internal switch is opened to allow 512)ACCEL INPUT/MON to become an input. Otherwise it remains a monitor of the calculated accel.

3.7.14 TORQUE COMPENSATOR / Accel input/monitor PIN 512

TORQUE COMPENSATOR 3  
512)ACCEL INPUT/MON

512)ACCEL INPUT/MON  
0.00%

Used to monitor accel, or input an external accel signal

PARAMETER	RANGE	DEFAULT	PIN
ACCEL INPUT/MON	to 105.00%	0.00%	512

See 3.7.12 TORQUE COMPENSATOR / Accel line speed input PIN 510

3.7.15 TORQUE COMPENSATOR / Accel filter time constant PIN 513

TORQUE COMPENSATOR 3  
513)ACCEL FILTER TC

513)ACCEL FILTER TC  
0.10 SECS

Sets a filter time constant for the line acceleration signal.

PARAMETER	RANGE	DEFAULT	PIN
ACCEL FILTER TC	0.00 to 200.00 SECS	0.10 SECS	513

If the line speed input or the external accel input signal used to derive the accel value have a ripple content then this may cause tension variations. The filter is provided to smooth the accel value. Use the accel monitor to set the filter time constant. Select the lowest filter time constant that gives a smooth accel value.

3.7.16 TORQUE COMPENSATOR / Tension demand input PIN 514

TORQUE COMPENSATOR 3  
514)TENSION DEM IP

514)TENSION DEM IP  
0.00%

Sets the tension demand input.

PARAMETER	RANGE	DEFAULT	PIN
TENSION DEM IP	+/-100.00%	0.00%	514



3.7.17 TORQUE COMPENSATOR / Tension scaler PIN 515

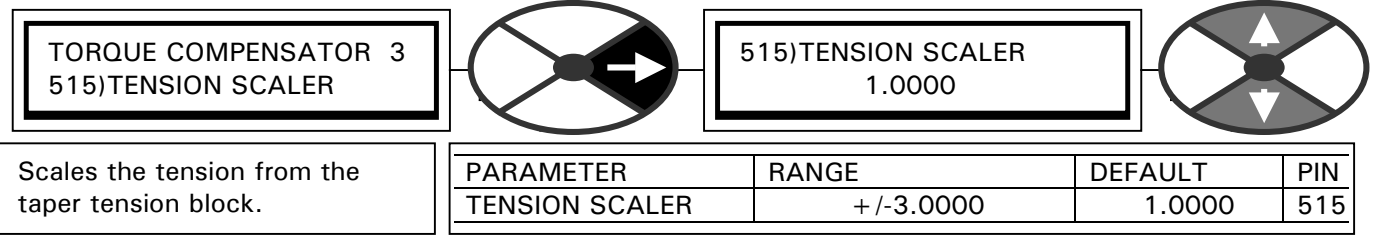

3.7.18 TORQUE COMPENSATOR / Torque memory select PIN 516

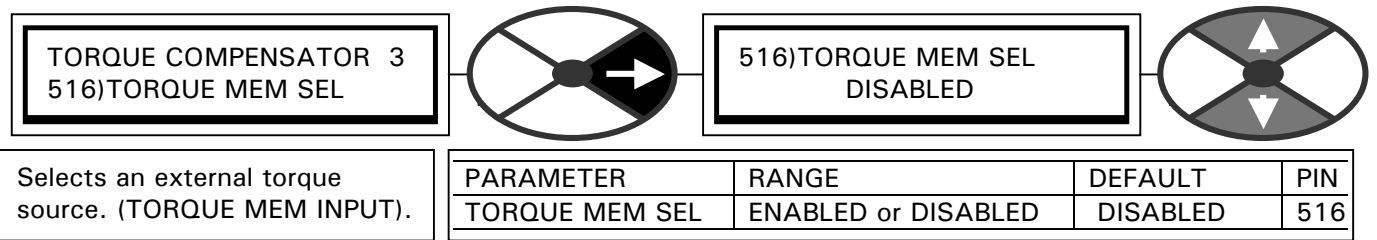

3.7.19 TORQUE COMPENSATOR / Torque memory input PIN 517

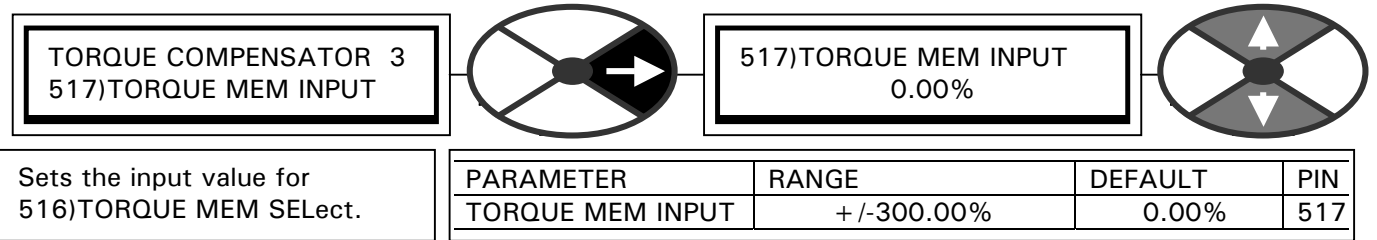

3.7.20 TORQUE COMPENSATOR / Tension enable PIN 518

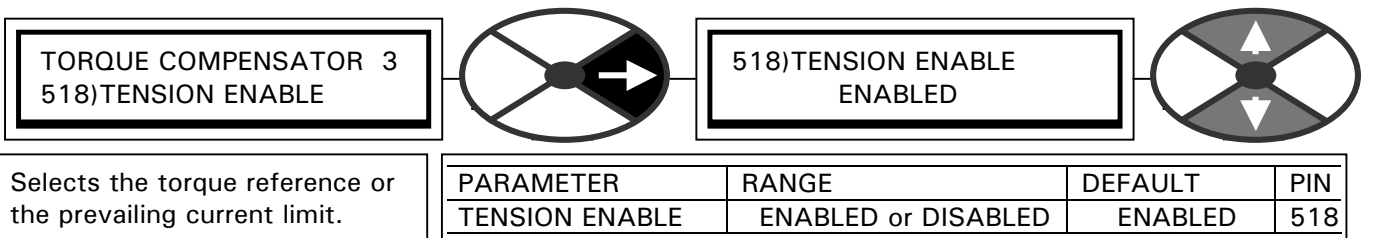

When winding, the drive system relies on arranging the speed loop to saturate so that the current is operating at the limit determined by the torque compensator. The speed loop saturation may be accomplished by adding an offset of say 10% to the speed demand of the reel drive.

3.7.21 TORQUE COMPENSATOR / Overwind/underwind PIN 519

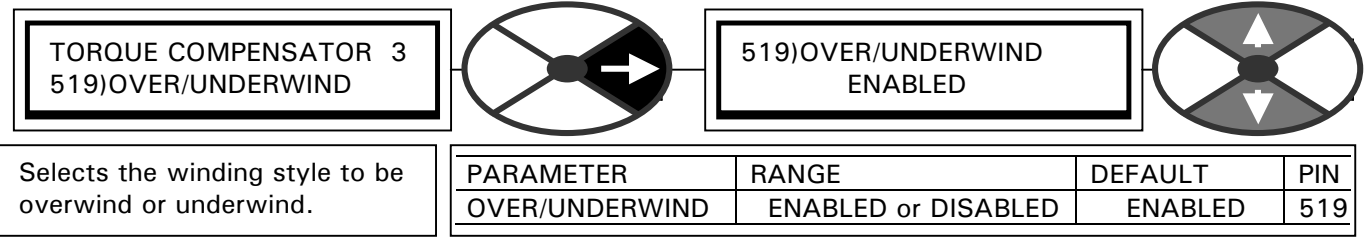

Overwinding is selected when the function is enabled. Underwind is selected when the function is disabled.

The term overwinding is referring to the chosen direction of layer addition on the reel. It assumes that the web is wound onto the reel in the direction which requires a positive current clamp. If the web is wound on in the underwind direction then the reel must change direction of rotation and the negative current clamp is operative.

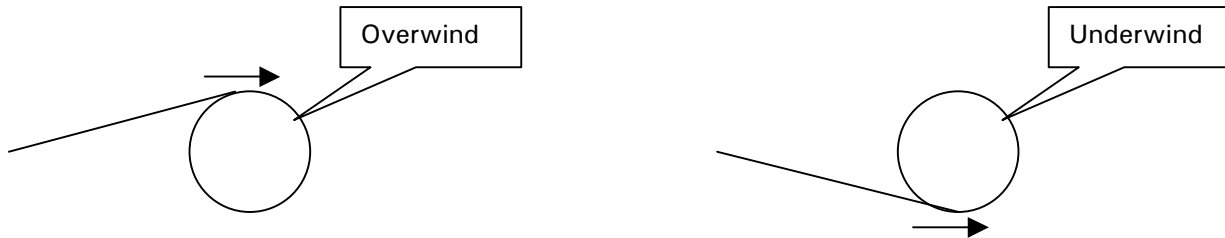

3.7.22 TORQUE COMPENSATOR / Inertia comp monitor PIN 520

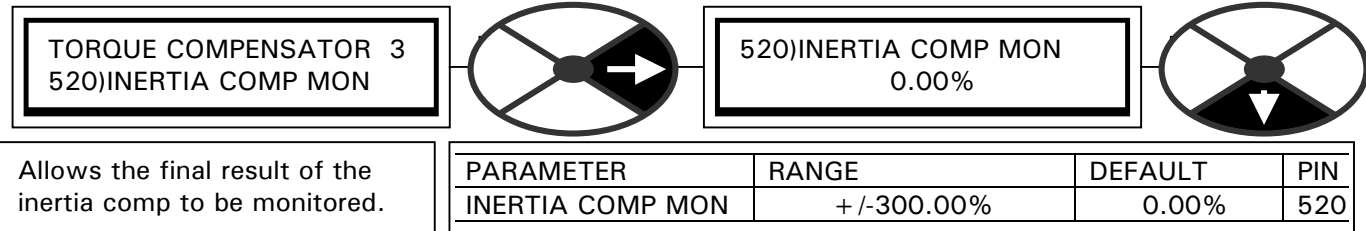

This has a branch hopping facility to 3.7.2 TORQUE COMPENSATOR / Torque demand monitor PIN 500.

3.8 Centre winding block arrangement

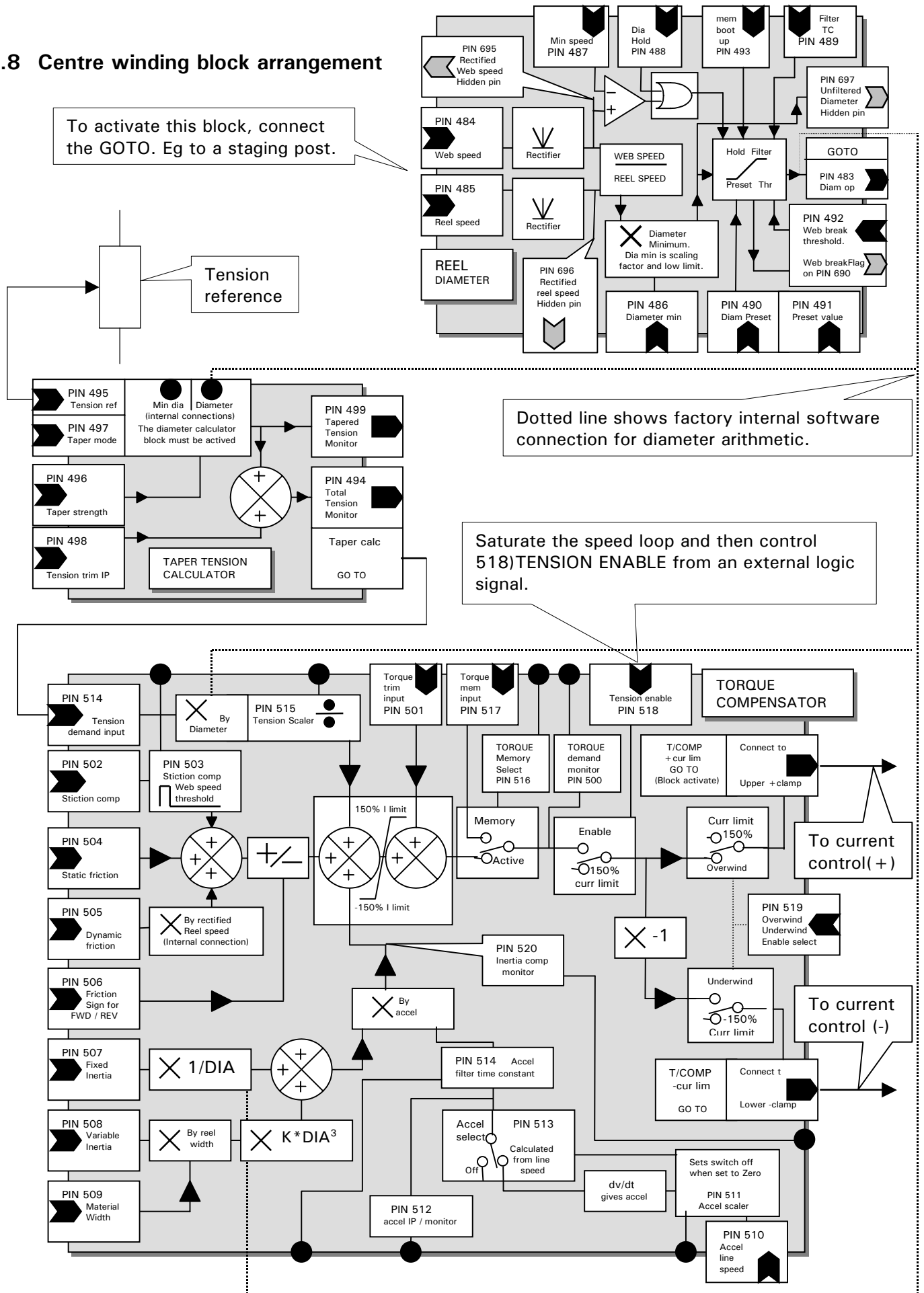

### 3.9 APPLICATION BLOCKS / PRESET SPEED

Pin numbers used 523 to 534

APPLICATION BLOCKS	2
PRESET SPEED	3

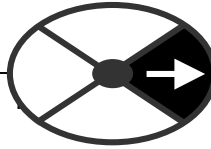

This block provides a versatile preset value selection machine. The primary use is for preset speeds. By defining output values for each one of 8 possible input combinations, various types of preset mode are possible. E. g. Input priority, input summing, BCD thumbwheel code.

This block contains 8 consecutive PINs with a range of +/-300.00% (527 to 534). If the block is not being used for its intended function then these PINs are ideal as extra STAGING POSTS.

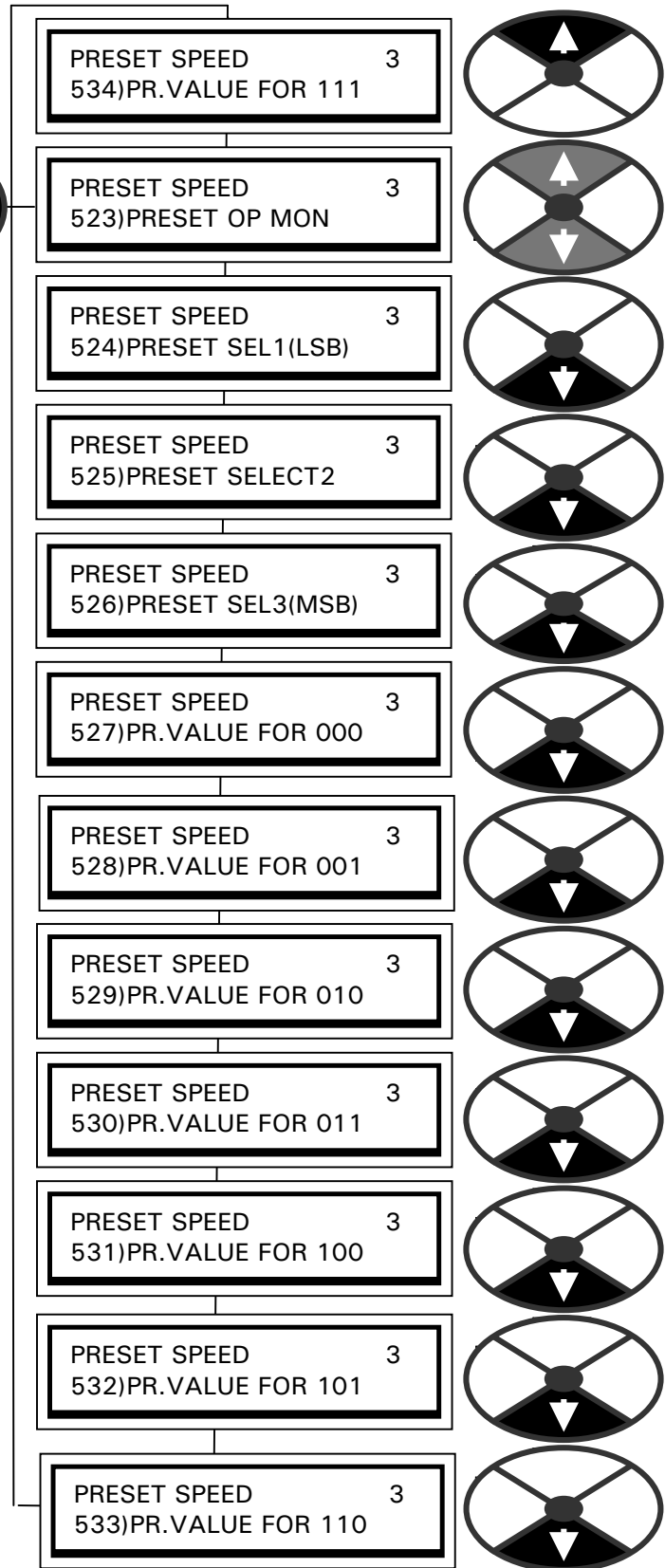

3.9.1 PRESET SPEED / Block diagram

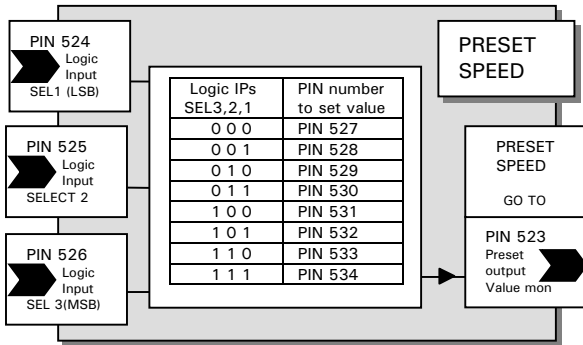

1) Ascending priority

Inputs 3,2,1	PIN number To set value	Actual value
0 0 0	PIN 527	0.00%
0 0 1	PIN 528	W%
0 1 0	PIN 529	X%
0 1 1	PIN 530	X%
1 0 0	PIN 531	Y%
1 0 1	PIN 532	Y%
1 1 0	PIN 533	Y%
1 1 1	PIN 534	Y%

Assuming that there are 3 output values (1 = W, 2 = X, 3 = Y) required and that logic select input 3 has the highest priority, followed by 2 and 1 in that order.

By entering the values for each PIN number as shown in the table the desired result is obtained.

2) Binary coded decimal

Inputs 3,2,1	PIN number OP value	Actual value
0 0 0	PIN 527	0.00%
0 0 1	PIN 528	10.00%
0 1 0	PIN 529	20.00%
0 1 1	PIN 530	30.00%
1 0 0	PIN 531	40.00%
1 0 1	PIN 532	50.00%
1 1 0	PIN 533	60.00%
1 1 1	PIN 534	70.00%

This will give 8 values up to 70.00% for the 8 BCD codes.

3) 4 digital inputs for 4 preset speeds.

Inputs 3,2,1	PIN number OP value	Actual value
0 0 0	PIN 527	25.00%
0 0 1	PIN 528	50.00%
0 1 0	PIN 529	75.00%
<b>0 1 1</b>	<b>PIN 530</b>	<b>62.50%</b>
1 0 0	PIN 531	100.00%
<b>1 0 1</b>	<b>PIN 532</b>	<b>75.00%</b>
<b>1 1 0</b>	<b>PIN 533</b>	<b>87.50%</b>
1 1 1	PIN 534	0.00%

Make the GOTO connection to the Value for low PIN on a digital input E.g. DIP1 on T14. Then connect the GOTO of DIP1 to the desired preset speed target PIN.

The DIP1 digital input will be the 25% input  
The preset speed select1 input will be the 50% input  
The preset speed select2 input will be the 75% input  
The preset speed select3 input will be the 100% input

The intermediate combinations are shown here bolded with intermediate values for smoother transition, but may be set to other values as desired.

3.9.2 PRESET SPEED / Preset speed output monitor PIN 523

PRESET SPEED 3  
523)PRESET SPEED MON

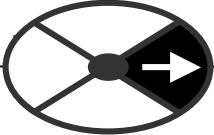

523)PRESET SPEED MON  
0.00%

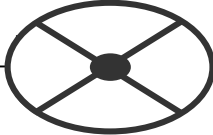

Allows the preset speed block output to be monitored.

PARAMETER	RANGE	DEFAULT	PIN
PRESET SPEED MON	+/-300.00%	0.00%	523

3.9.3 PRESET SPEED / Select bit inputs 1 lsb, 2, 3 msb PINs 524 / 525 / 526

PRESET SPEED 3  
524)PRESET SEL1(LSB)

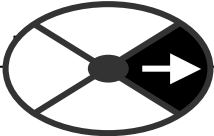

524)PRESET SEL1(LSB)  
LOW

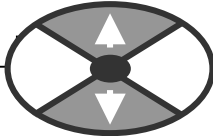

Sets the logic state of the preset speed block digital input.

PARAMETER	RANGE	DEFAULT	PIN
PRESET SEL1(LSB)	HIGH or LOW	LOW	524

3.9.4 PRESET SPEED / OP value of 000 to 111 PINs 527 to 534

PRESET SPEED 3  
527)PR.VALUE FOR 000

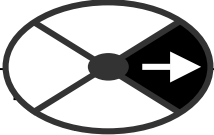

527)PR.VALUE FOR 000  
0.00%

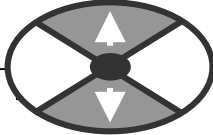

Sets the values for each preset speed block digital input code.

PARAMETER	RANGE	DEFAULT	PIN
PR.VALUE FOR 000	+/-300.00%	0.00%	527

See 3.9.1 PRESET SPEED / Block diagram.

### 3.10 APPLICATION BLOCKS / MULTI-FUNCTION 1 to 8

PINs used 544 to 559

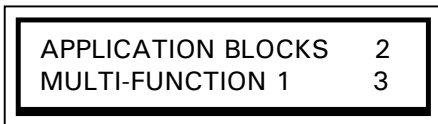

There are 8 identical independent MULTI FUNCTION blocks. They are identified by the suffix 1 to 8 in the menu windows.

Only number 1 is shown here.

They are used to perform simple signal processing on 1 or 2 signals.

Available functions are comparator, AND, OR, LOGIC INVERT, sign change, rectify and sample and hold. These blocks may also be used as JUMPERS to make connections.

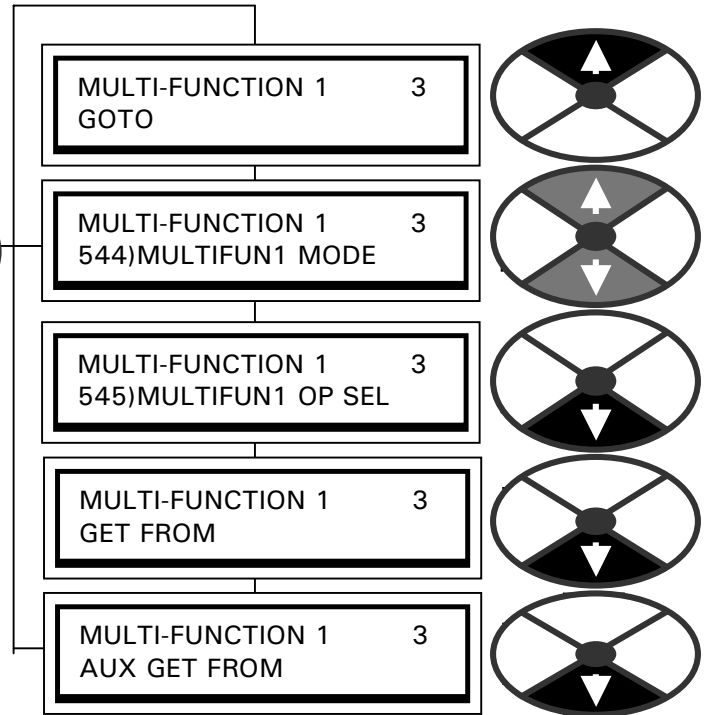

#### 3.10.1 MULTI-FUNCTION / Block diagram

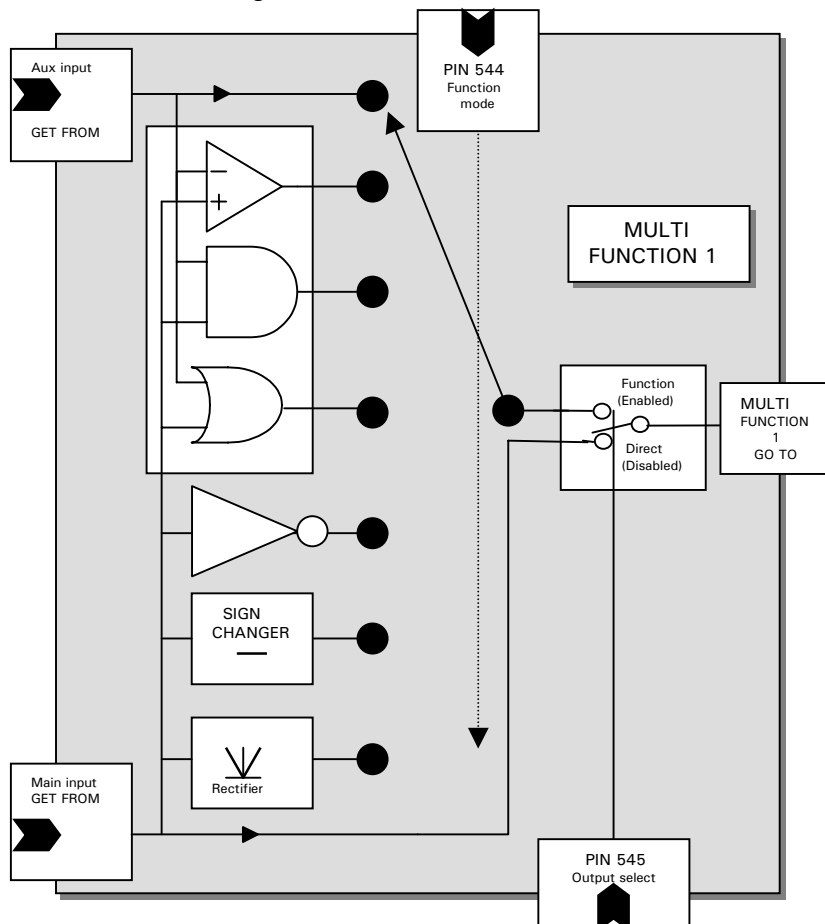

3.10.2 MULTI-FUNCTION 1 to 8 / Function mode PINs 544/6/8, 550/2/4/6/8

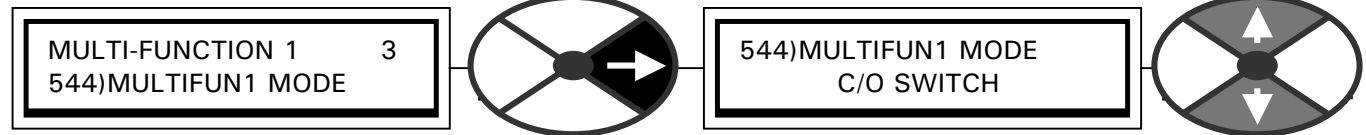

Select 1 of 7 transfer functions according the table below.

PARAMETER	RANGE	DEFAULT	PIN
MULTIFUN1 MODE	1 of 7 functions	C/O SWITCH	544

Note that a linear signal will be treated as a logical 0 by a logical function if its value is zero (any units), any other value including negative values will be treated as a logical 1.

Mode	Function	Function type	OP Description for MULTIFUN1 OP SEL ENABLED															
0	C/O SWITCH Or JUMPER	Linear or logical	The value at the aux input Use this for connections if JUMPERS are all used															
1	COMPARATOR	2 linear inputs, logical output	If MAIN > AUX output = 1 If MAIN < AUX output = 0															
2	AND GATE	2 logical inputs, logical output	<table border="1"> <thead> <tr> <th>MAIN</th> <th>AUX</th> <th>Output</th> </tr> </thead> <tbody> <tr> <td>0</td> <td>0</td> <td>0</td> </tr> <tr> <td>0</td> <td>1</td> <td>0</td> </tr> <tr> <td>1</td> <td>0</td> <td>0</td> </tr> <tr> <td>1</td> <td>1</td> <td>1</td> </tr> </tbody> </table>	MAIN	AUX	Output	0	0	0	0	1	0	1	0	0	1	1	1
MAIN	AUX	Output																
0	0	0																
0	1	0																
1	0	0																
1	1	1																
3	OR GATE	2 logical inputs, logical output	<table border="1"> <thead> <tr> <th>MAIN</th> <th>AUX</th> <th>Output</th> </tr> </thead> <tbody> <tr> <td>0</td> <td>0</td> <td>0</td> </tr> <tr> <td>0</td> <td>1</td> <td>1</td> </tr> <tr> <td>1</td> <td>0</td> <td>1</td> </tr> <tr> <td>1</td> <td>1</td> <td>1</td> </tr> </tbody> </table>	MAIN	AUX	Output	0	0	0	0	1	1	1	0	1	1	1	1
MAIN	AUX	Output																
0	0	0																
0	1	1																
1	0	1																
1	1	1																
4	INVERT	1 logical input, logical output	<table border="1"> <thead> <tr> <th>MAIN</th> <th>Output (Main + OP select, make EXOR)</th> </tr> </thead> <tbody> <tr> <td>0</td> <td>1</td> </tr> <tr> <td>1</td> <td>0</td> </tr> </tbody> </table>	MAIN	Output (Main + OP select, make EXOR)	0	1	1	0									
MAIN	Output (Main + OP select, make EXOR)																	
0	1																	
1	0																	
5	SIGN CHANGER	1 linear input, linear output	Output = MAIN X (-1)															
6	RECTIFIER	1 linear input, linear output	Output =   MAIN															

3.10.2.1 Sample and hold function

To perform a sample and hold simply set the AUX GET FROM source PIN to be the same as the output GOTO destination PIN and the MODE to 0. Then when the output select is disabled the output value will follow the main input. When the output select is enabled, the value pertaining at that time will be held.  
See also 3.16.1.1 C/O switch used as sample and hold function.

3.10.3 MULTI-FUNCTION 1 to 8 / Output select 1 to 8 PIN 545/7/9, 551/3/5/7/9

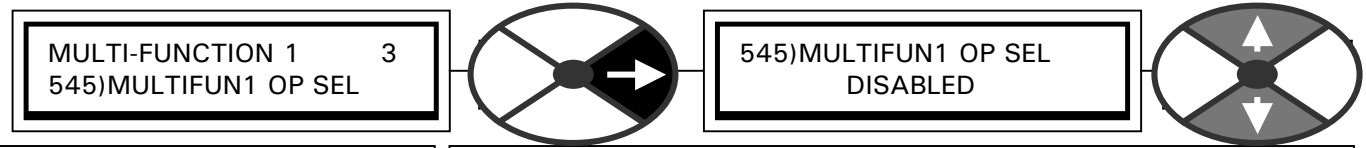

When disabled the main input flows directly to the output.

PARAMETER	RANGE	DEFAULT	PIN
MULTIFUN1 OP SEL	ENABLED or DISABLED	DISABLED	545

When enabled, 1 of 7 transfer functions selected by the logic mode switch is then output.  
When this PIN is used as a logic input with the main input in invert mode, the output is EXOR of the 2 inputs.

3.10.4 MULTI-FUNCTION 1 to 8 / Main input GET FROM 1 to 8

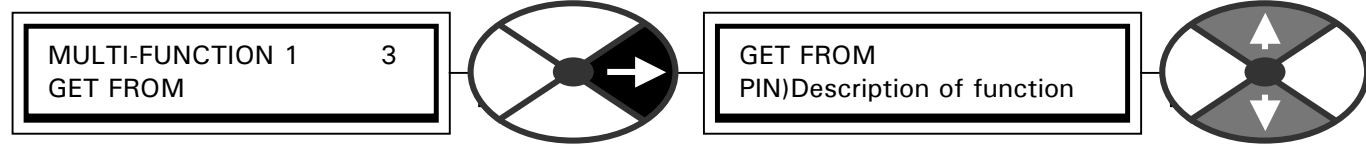

Sets the PIN for the main input signal source.

PARAMETER	RANGE	DEFAULT
GET FROM	000 to 720	400)Block disconnect



3.10.5 MULTI-FUNCTION 1 to 8 / Aux input GET FROM 1 to 8

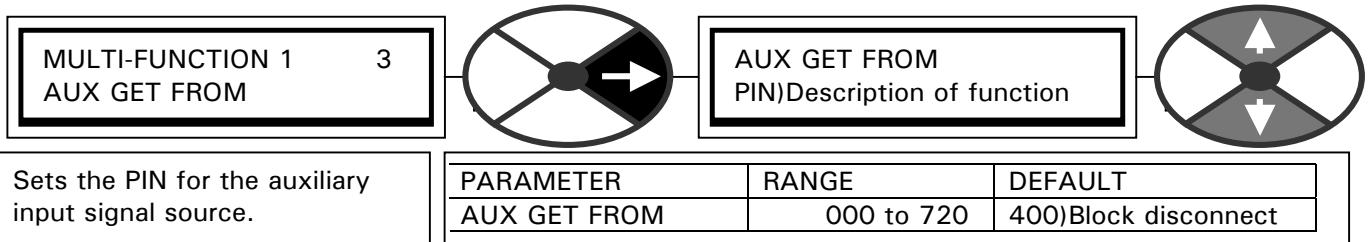

3.10.6 MULTI-FUNCTION 1 to 8 / GOTO 1 to 8

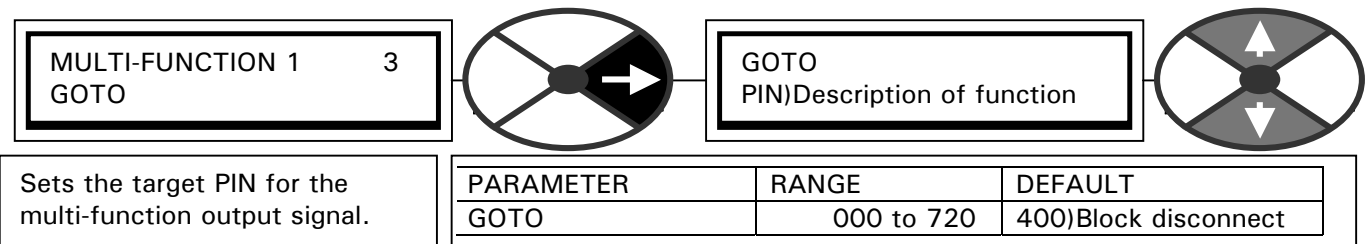

### 3.11 APPLICATION BLOCKS / LATCH

PINs used 560 to 566

APPLICATION BLOCKS	2
LATCH	3

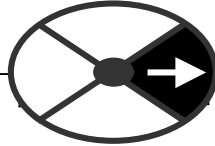

This block provides a standard D type latch function. The logic inputs are scanned at least once every 50mS hence the maximum operating frequency is 10Hz. See 3.1.1 Sample times.

#### 3.11.1 LATCH / Block diagram

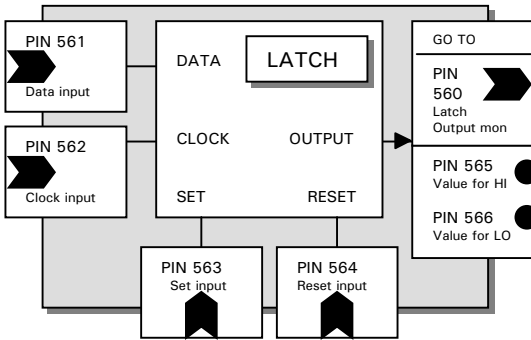

SET	RESET	CLOCK	DATA	OUTPUT
High	Low	Don't care	Don't care	Value for high
Low	High	Don't care	Don't care	Value for low
High	High	Don't care	Don't care	Value for high
Low	Low	+ VE EDGE	Low	Value for low
Low	Low	+ VE EDGE	High	Value for high

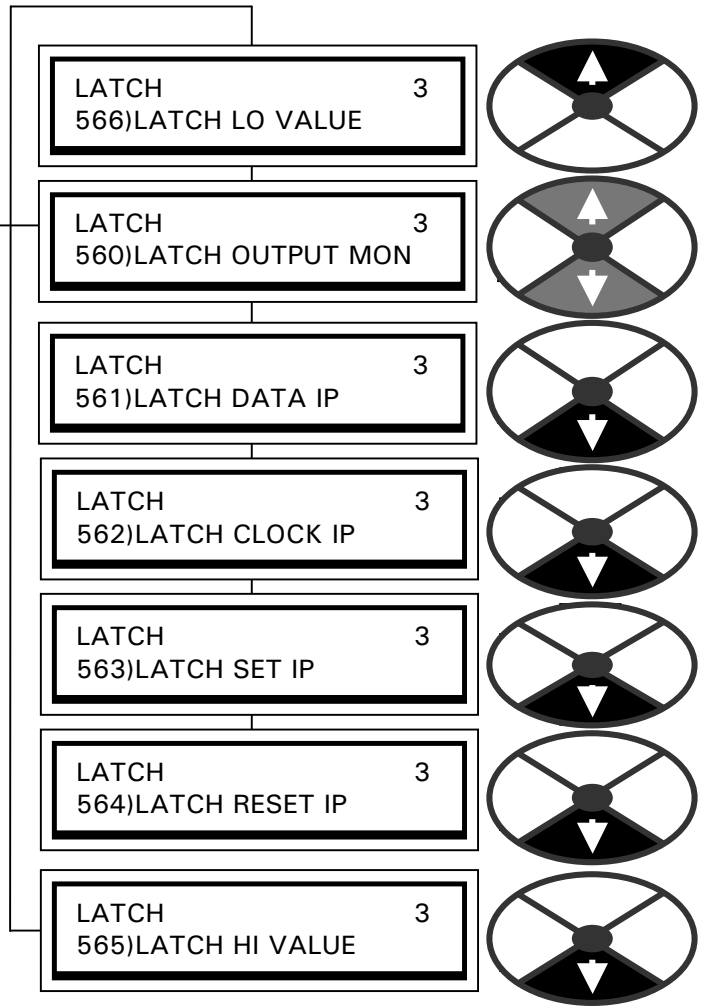

#### 3.11.2 LATCH / Latch output monitor PIN 560

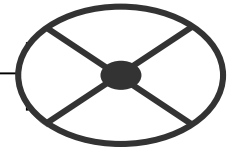
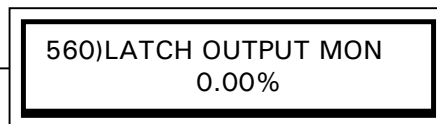
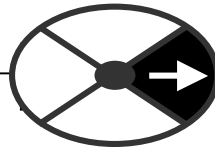

Shows the output value of the latch block.

PARAMETER	RANGE	DEFAULT	PIN
LATCH OUTPUT MON	+ /-300.00%	0.00%	560

#### 3.11.3 LATCH / Latch data input PIN 561

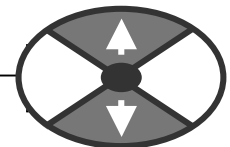
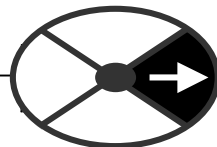

Sets logic level for the data input. Min dwell time 50mS.

PARAMETER	RANGE	DEFAULT	PIN
LATCH DATA IP	LOW or HIGH	LOW	561

If the clock level has changed from a low to a high since the last sample, then the logic level of the data input (high or low) is placed on the latch output stage giving an output value for high or low.

3.11.4 LATCH / Latch clock input PIN 562

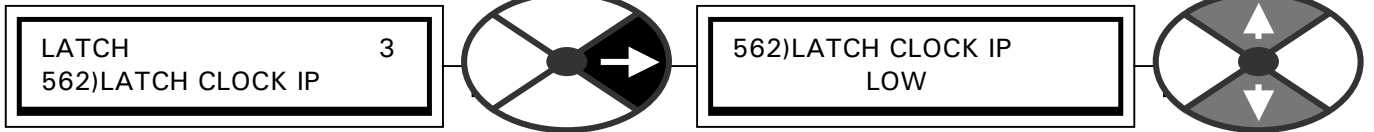

Sets logic level for the latch clock input.

PARAMETER	RANGE	DEFAULT	PIN
LATCH CLOCK IP	LOW or HIGH	LOW	562

If the clock level has changed from a low to a high since the last sample, then the logic level of the data input (high or low) is placed on the latch output stage giving an output value for high or low. See the truth table for a complete definition.

3.11.5 LATCH / Latch set input PIN 563

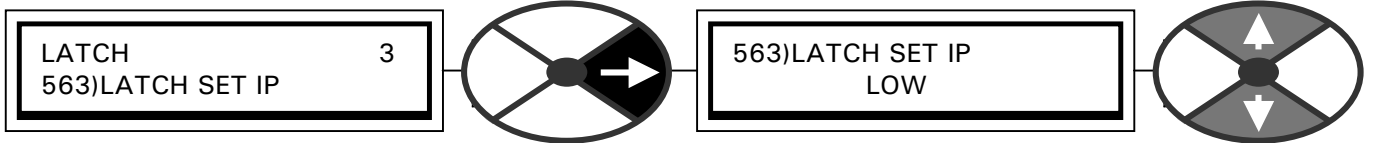

Sets logic level for the latch set input.

PARAMETER	RANGE	DEFAULT	PIN
LATCH SET IP	LOW or HIGH	LOW	563

See the truth table for a complete definition.

3.11.6 LATCH / Latch reset input PIN 564

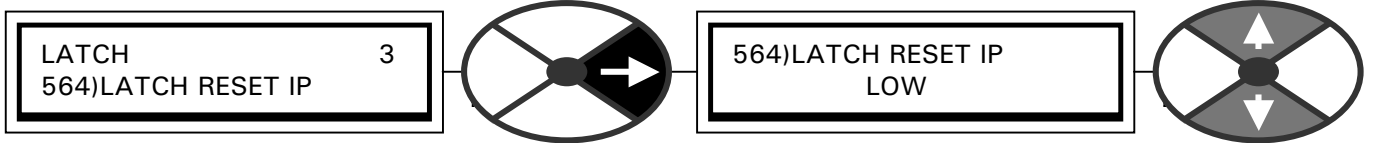

Sets logic level for the latch reset input.

PARAMETER	RANGE	DEFAULT	PIN
LATCH RESET IP	LOW or HIGH	LOW	564

See the truth table for a complete definition.

3.11.7 LATCH / Latch output value for HI/LOW PINs 565 / 566

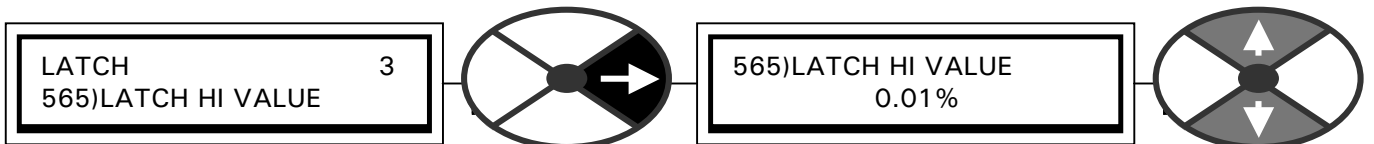

Sets the output value for the high result

PARAMETER	RANGE	DEFAULT	PIN
LATCH HI VALUE	+/-300.00%	0.01%	565

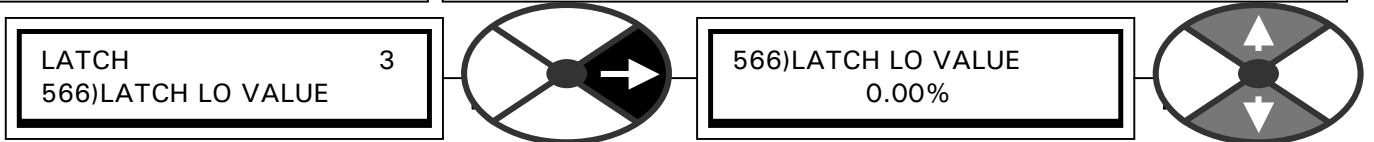

Sets the output value for the low result

PARAMETER	RANGE	DEFAULT	PIN
LATCH LO VALUE	+/-300.00%	0.00%	566

### 3.12 APPLICATION BLOCKS / FILTER 1, 2

PINs used 568/9 and 573/4  
There are 2 identical filter blocks

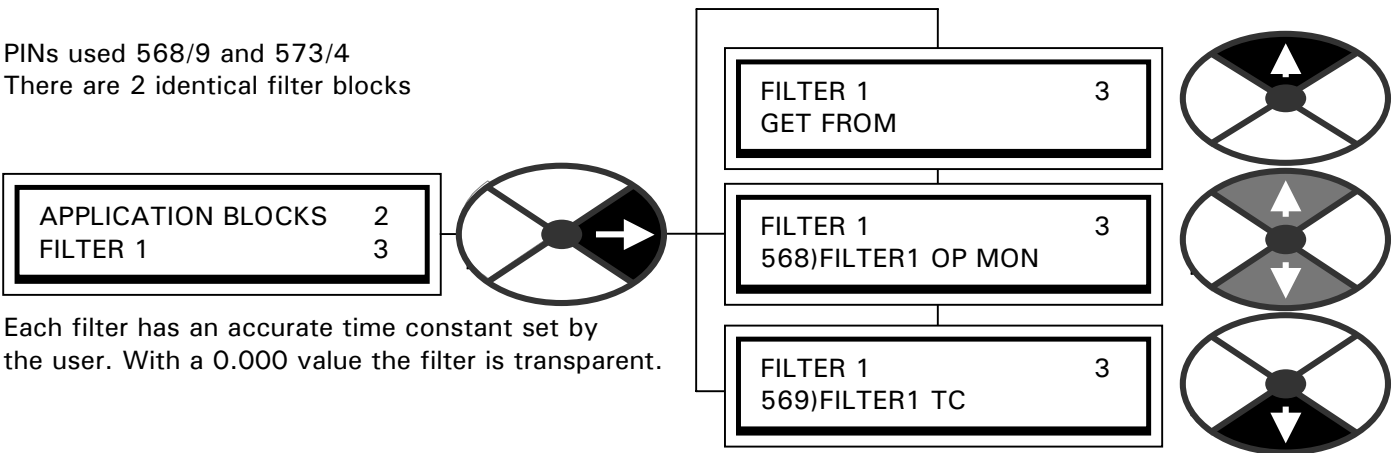

Each filter has an accurate time constant set by the user. With a 0.000 value the filter is transparent.

There is also a simple low pass filter in the hidden PIN list. Input is PIN 705, and output is PIN 706

#### 3.12.1 FILTER / Block diagram

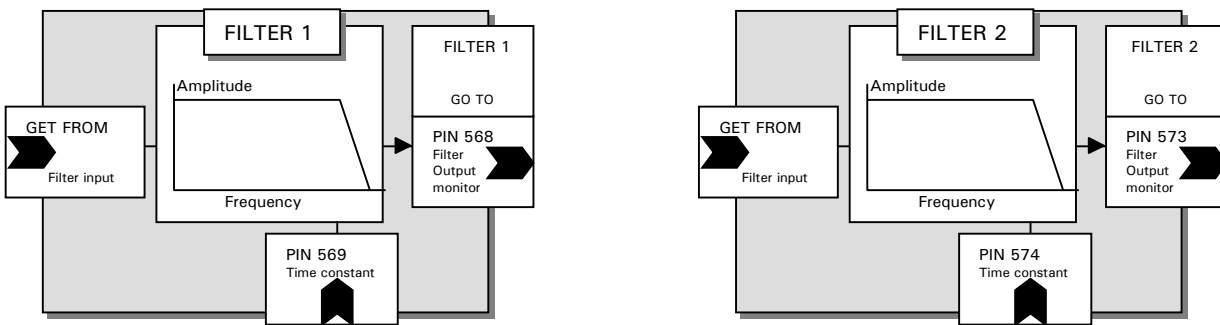

The filters are useful for eliminating mechanical resonance effects from the control system closed loop.

#### 3.12.2 FILTER 1, 2 / Filter output monitor PIN 568 / 573

Allows the filter 1 output to be monitored.

PARAMETER	RANGE	DEFAULT	PIN
FILTER1 OP MON	+/-315.00%	0.00%	568

#### 3.12.3 FILTER 1, 2 / Filter time constant PIN 569 / 574

Sets the value of the time constant for the filter 1 block.

PARAMETER	RANGE	DEFAULT	PIN
FILTER1 TC	0.000 to 32.000 SECS	1.000 SECS	569

For filter time constants in excess of 32.000 seconds, the filters may be cascaded.

### 3.12.4 FIXED LOW PASS FILTER

There is a simple low pass filter function with a cut off frequency of approximately 10 Hz.

It may be useful for smoothing linear signals or eliminating resonances.

The filter does not have any adjustments hence the PIN numbers are hidden.

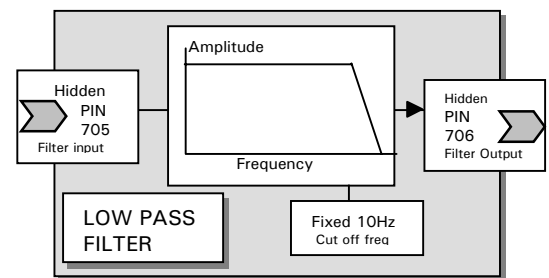

To use the filter connect the input using a GOTO window from another block, and connect the output using a GETFROM from the destination block. Alternatively use JUMPERS to make the connections.

### 3.13 APPLICATION BLOCKS / BATCH COUNTER

PINs used 578 to 582

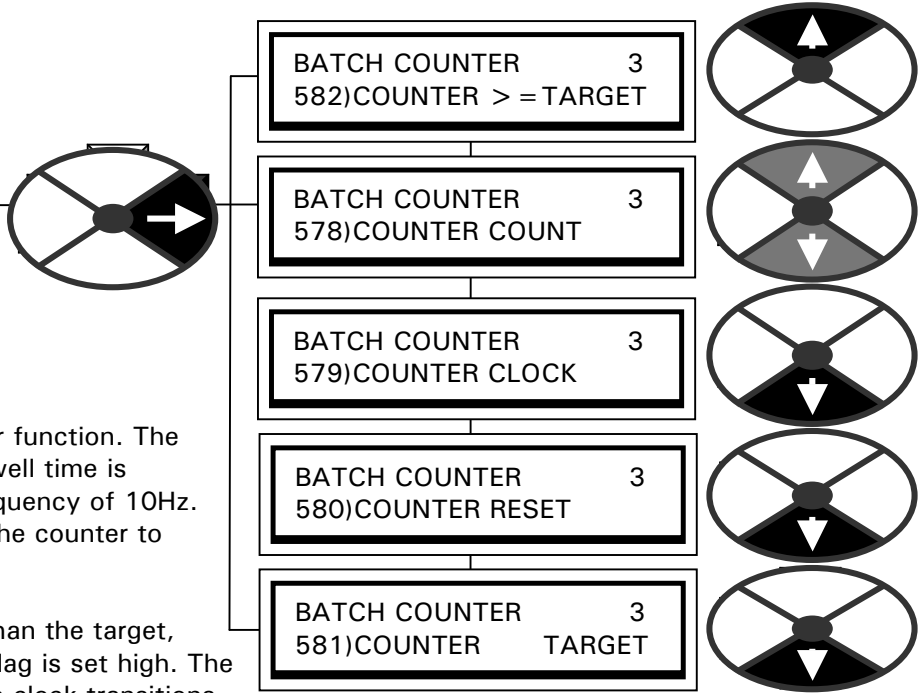

This block provides a batch counter function. The minimum low or high logic input dwell time is 50mS giving a maximum count frequency of 10Hz. A positive clock transition causes the counter to count up.

If the count is equal to or greater than the target, then 582)COUNTER > = TARGET flag is set high. The counter continues counting positive clock transitions unless the reset input is high or the counter reaches 32000. This feature is useful if the counter is used to signal intermediate points within a total batch. The count target may be changed without interfering with the counting process.

The reset input resets the counter to zero.

#### 3.13.1 BATCH COUNTER / Block diagram

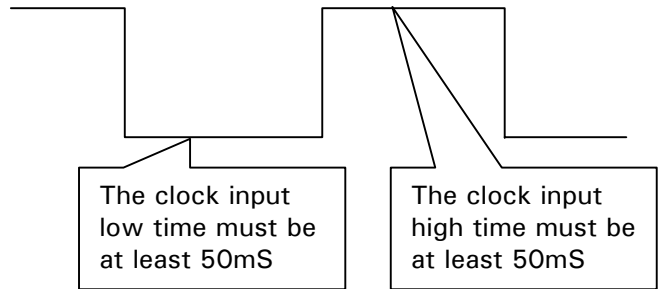
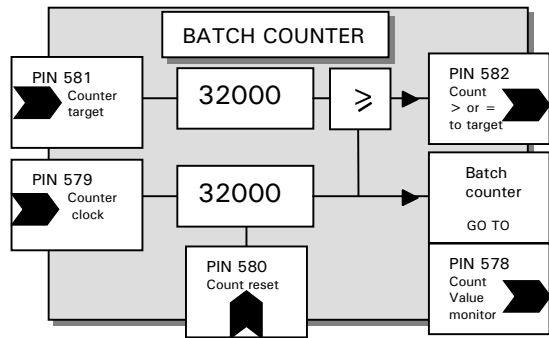

See 3.1.1 Sample times.

#### 3.13.2 BATCH COUNTER / Counter count monitor PIN 578

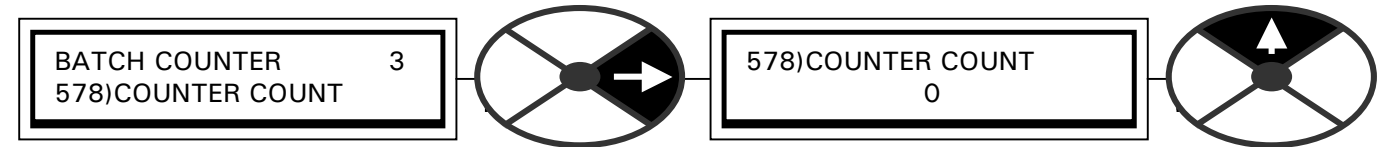

Allows the batch counter value to be monitored.

PARAMETER	RANGE	PIN
COUNTER COUNT	0 to 32000	578

Note. This value is the output of the block GOTO connection.

This window has a branch hopping facility to 3.13.6 BATCH COUNTER / Count equal or greater than target flag PIN 582.

3.13.3 BATCH COUNTER / Clock input PIN 579

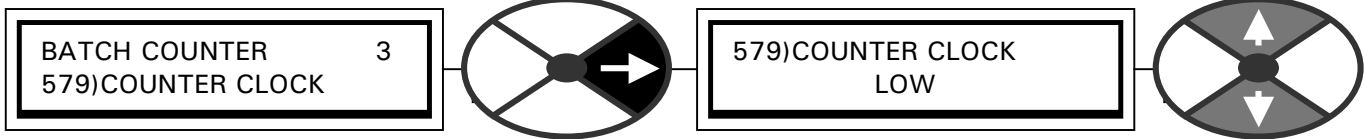

Sets the clock input logic level for the batch counter.

PARAMETER	RANGE	DEFAULT	PIN
COUNTER CLOCK	LOW or HIGH	LOW	579

The counter will increment on a positive clock transition.

3.13.4 BATCH COUNTER / Reset input PIN 580

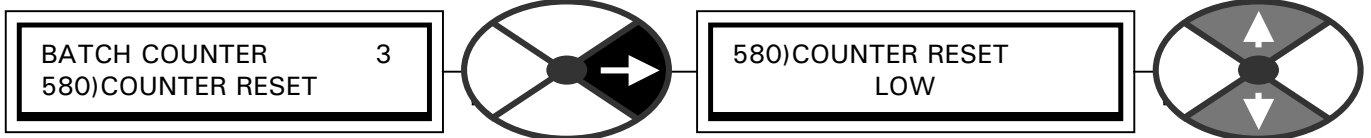

Sets the reset input logic level for the batch counter.

PARAMETER	RANGE	DEFAULT	PIN
COUNTER RESET	LOW or HIGH	LOW	580

The counter is held reset while the reset input is high.

3.13.5 BATCH COUNTER / Counter target number PIN 581

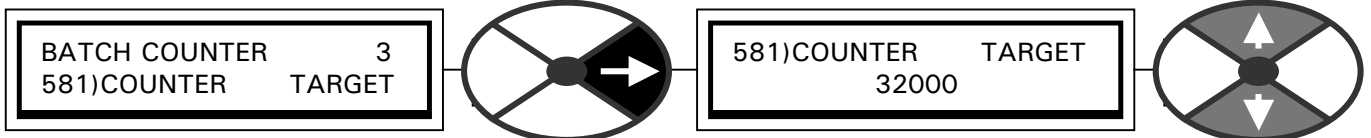

Sets the target number for the batch counter.

PARAMETER	RANGE	DEFAULT	PIN
COUNTER TARGET	0 to 32000	32000	581

When the batch counter value equals or exceeds the target value this output goes high. Changing the counter target does not interfere with the counting process.

3.13.6 BATCH COUNTER / Count equal or greater than target flag PIN 582

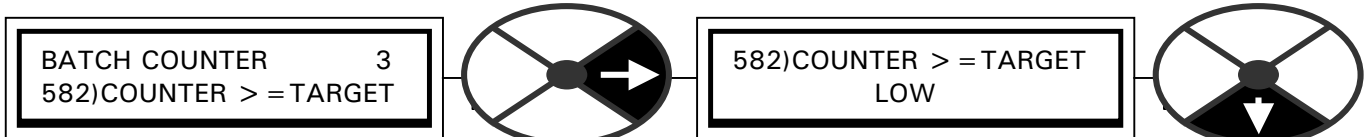

Allows the equal or greater output flag to be monitored.

PARAMETER	RANGE	PIN
COUNTER >= TARGET	LOW or HIGH	582

When the batch counter value equals or exceeds the target value the equal output goes high.

Note. By using a jumper to connect this flag to 580)COUNTER RESET, it is possible to make the counter roll over at the counter target number and continue counting from 0 again.

Branch hopping facility to 3.13.2 BATCH COUNTER / Counter count monitor PIN 578

### 3.14 APPLICATION BLOCKS / INTERVAL TIMER

PINs used 584 to 586

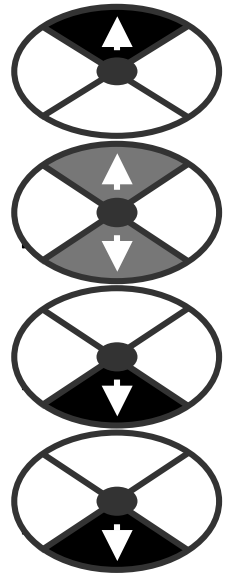
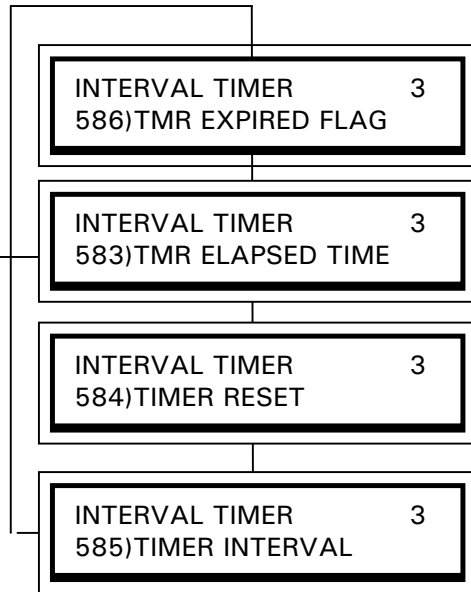
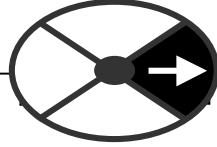
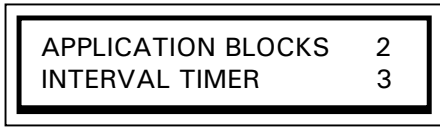

#### 3.14.1 INTERVAL TIMER / Block diagram

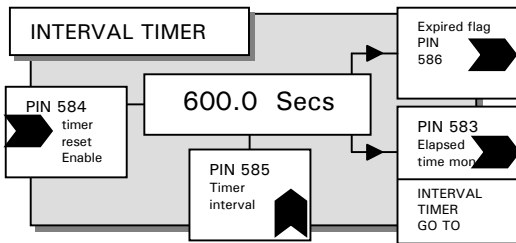

The INTERVAL TIMER may be used to control event sequencing in systems applications.

E. g. If a motion control sequence must wait before starting or a relay changeover delayed.

#### 3.14.2 INTERVAL TIMER / Time elapsed monitor PIN 583

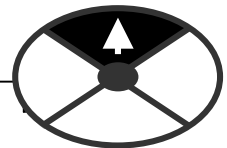
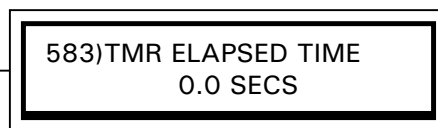
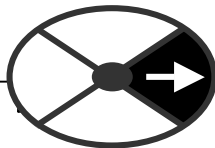

Allows the interval timer elapsed time to be monitored.

PARAMETER	RANGE	DEFAULT	PIN
TMR ELAPSED TIME	0.1 to 600.0 SECS	0.0 SECS	583

Note. This value is the output of the block GOTO connection.

When the total interval time has elapsed the block output goes high until the next disable/enable sequence. This window has a branch hopping facility to 3.14.5 INTERVAL TIMER / Timer expired flag PIN 586.

#### 3.14.3 INTERVAL TIMER / Timer reset enable PIN 584

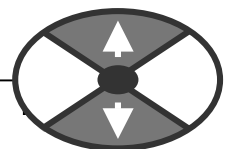
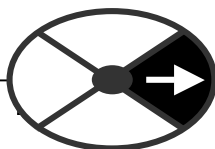

When enabled the timer is reset to and held at zero.

PARAMETER	RANGE	DEFAULT	PIN
TIMER RESET	ENABLED or DISABLED	DISABLED	584

The timer commences timing when disabled. The timer is reset if the input is enabled prior to timing out.



3.14.4 INTERVAL TIMER / Time interval setting PIN 585

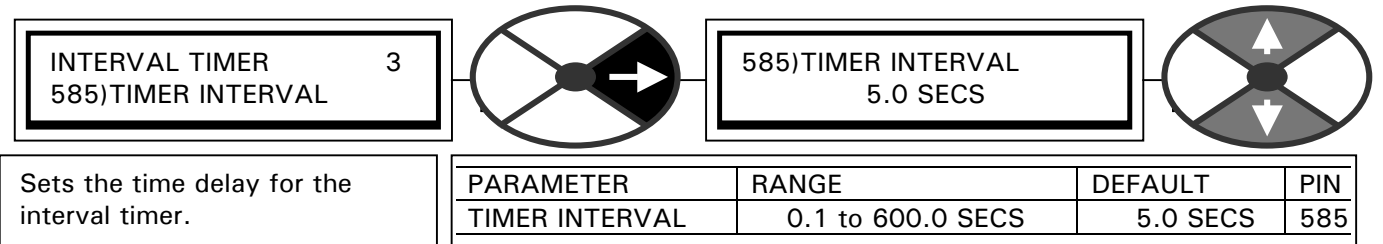

When the time delay has elapsed the block output goes high. It stays high until the next disable input.

3.14.5 INTERVAL TIMER / Timer expired flag PIN 586

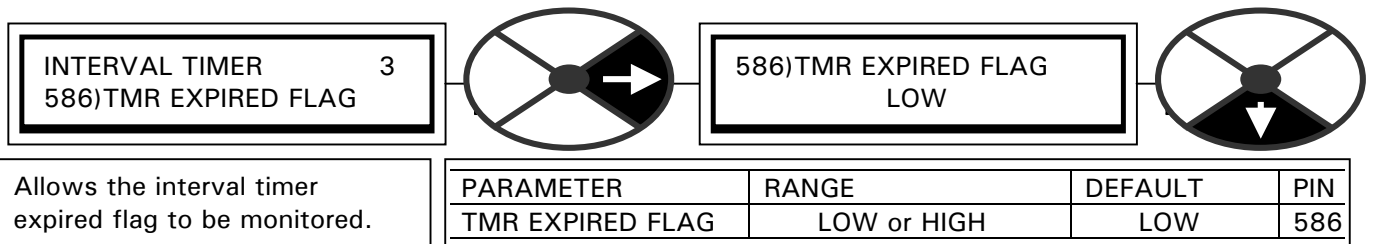

This window has a branch hopping facility to 3.14.2 INTERVAL TIMER / Time elapsed monitor PIN 583.

Note. By connecting this flag to 584)TIMER RESET using a jumper, it is possible to make the timer roll over and continue timing from 0 again.

### 3.15 APPLICATION BLOCKS / COMPARATOR 1 to 4

Pins 588 to 603

There are 4 identical comparators each with adjustable hysteresis and a window mode option. This description applies to all 4.

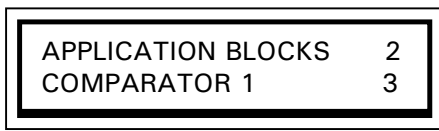

#### 3.15.1 COMPARATOR 1 / Block diagram

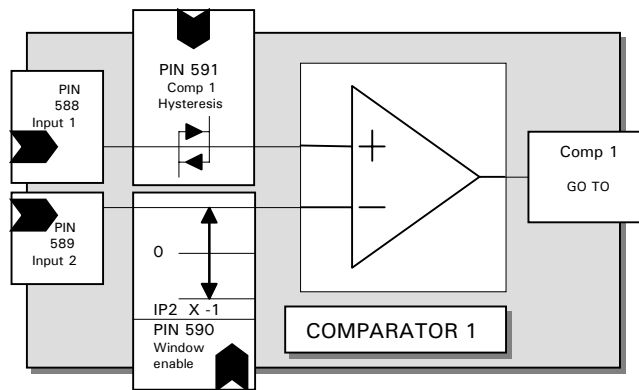

With the window mode disabled, the block functions as a comparator with input 1 on the positive input and input 2 on the negative input.

The hysteresis level is applied above and below the value of input 1. The hysteresis range is 0 - 10.00%.

If the window mode is enabled, then the value on input 2 creates a symmetrical window around zero. If the value on input 1 lies within the window then the comparator output is high. If hysteresis is used in the window mode it is applied at each boundary.

#### 3.15.2 COMPARATOR 1/2/3/4 / Input 1 PIN 588/592/596/600

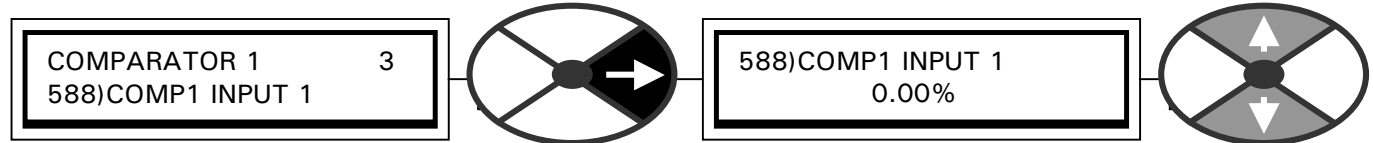

Sets the level of input 1 (+ve) of the comparator 1.

PARAMETER	RANGE	DEFAULT	PIN
COMP1 INPUT 1	+/- 300.00%	0.00%	588

The output is high for input 1 > input 2 (algebraic). The output is low for input 1 = < input 2 (algebraic).

#### 3.15.3 COMPARATOR 1/2/3/4 / Input 2 PIN 589/593/597/601

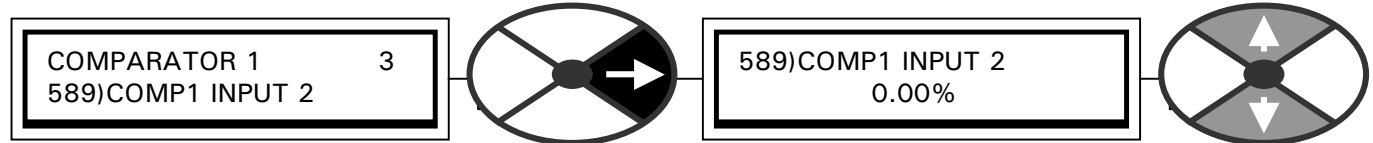

Sets the level of input 2 (-ve) of the comparator 1.

PARAMETER	RANGE	DEFAULT	PIN
COMP1 INPUT 2	+/- 300.00%	0.00%	589

The output is high for input 1 > input 2 (algebraic). The output is low for input 1 = < input 2 (algebraic).

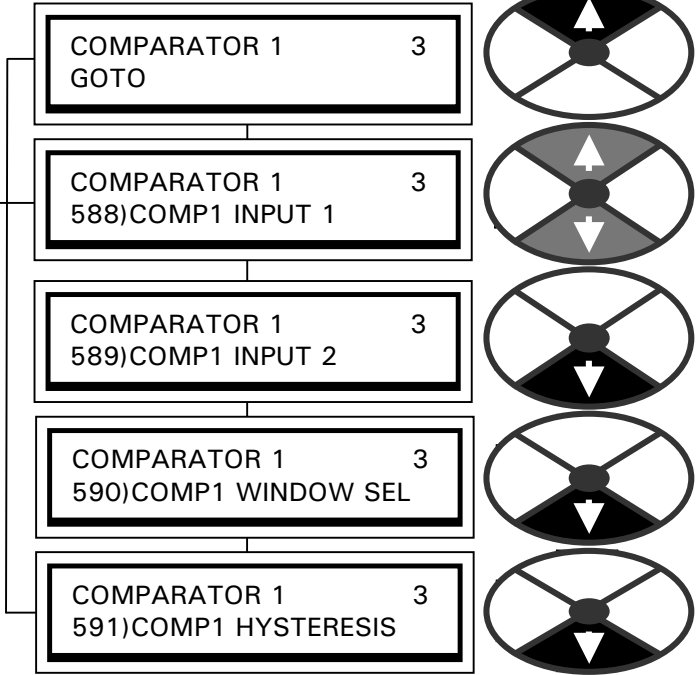

3.15.4 COMPARATOR 1/2/3/4 / Window mode select PIN 590/594/598/602

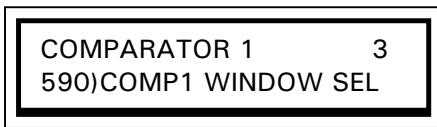

Enables the window comparator mode.

PARAMETER	RANGE	DEFAULT	PIN
COMP1 WINDOW SEL	ENABLED or DISABLED	DISABLED	590

The output is **low** for input 1 > or = < the window amplitude created by input 2 (algebraic).  
 The window is created symmetrically around 0.00% and has a range of +/- input 2.  
 If hysteresis is applied it operates at each boundary of the window.

3.15.5 COMPARATOR 1/2/3/4 / Hysteresis PIN 591/595/599/603

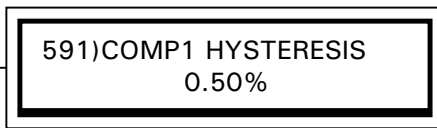
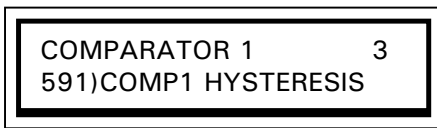

Sets the level of hysteresis applied to input 1 (-ve).

PARAMETER	RANGE	DEFAULT	PIN
COMP1 HYSTERESIS	0 to 10.00%	0.50%	591

E. g. A value of 1.00% requires input 1 to exceed input 2 by more than 1.00% for a high output and to fall below input 2 by 1.00% or more to go low.

3.15.6 COMPARATOR 1/2/3/4 / Comparator GOTO

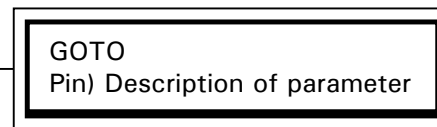
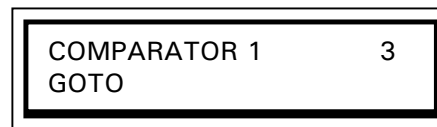

Sets the PIN for the GOTO connection target parameter.

PARAMETER	RANGE	DEFAULT
GOTO	2 to 720	400)Block disconnect

Note. To activate the block the GOTO must be connected to a PIN other than 400)Block disconnect.

3.16 APPLICATION BLOCKS / C/O SWITCH 1 to 4

Pins 604 to 615

There are 4 identical changeover switches each with 2 inputs and 1 output. This description applies to all 4.

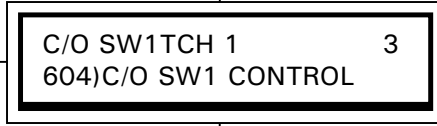
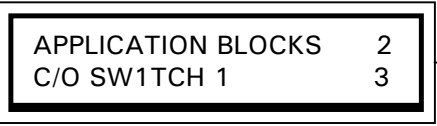

3.16.1 C/O SWITCH / Block diagram

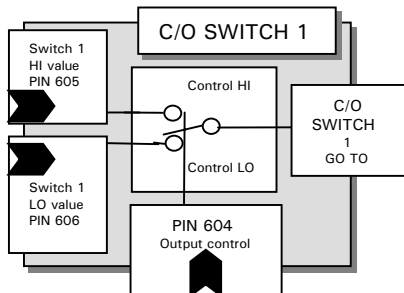

3.16.1.1 C/O switch used as sample and hold function

Note. A sample and hold function can be implemented by connecting the output to 606)C/O SW1 LO VALUE. The value on 605)C/O SW1 HI VALUE will be transferred to 606)C/O SW1 LO VALUE when 604)C/O SW1 CONTROL is HIGH. It will be held at the value pertaining when the control goes LOW.

3.16.2 C/O SWITCH 1/2/3/4 / Control PIN 604/607/610/613

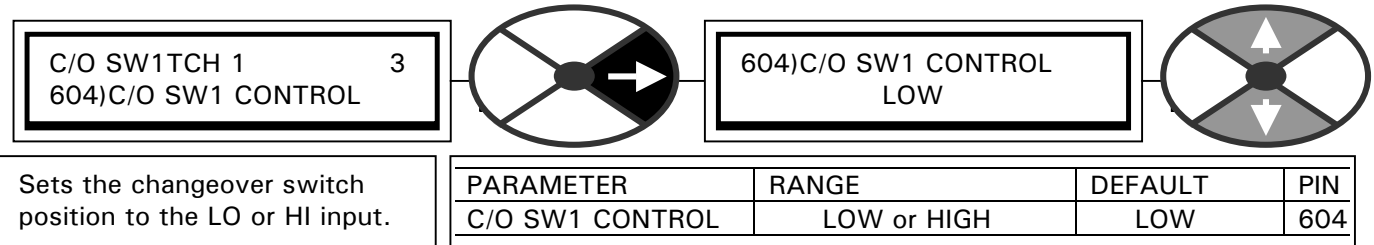

Sets the changeover switch position to the LO or HI input.

3.16.3 C/O SWITCH 1/2/3/4 / Inputs HI/LO PIN 605/608/611/614 / 606/609/612/615

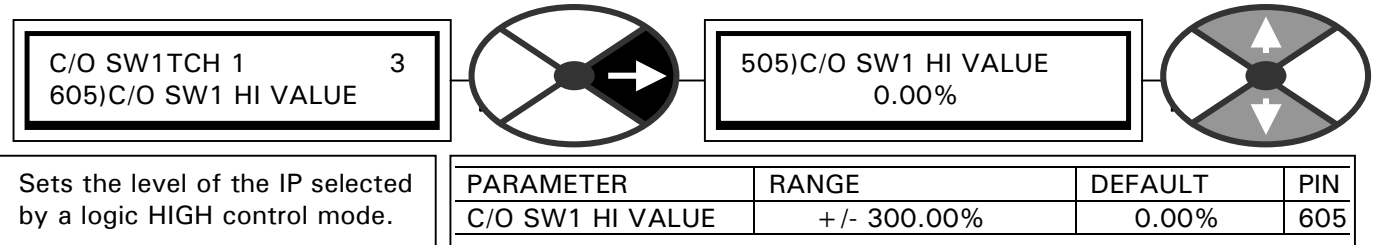

Sets the level of the IP selected by a logic HIGH control mode.

Note. 606)C/O SW1 LO VALUE Sets the level of the IP selected by a logic LOW control mode.

3.16.4 C/O SWITCH 1/2/3/4 / C/O switch GOTO

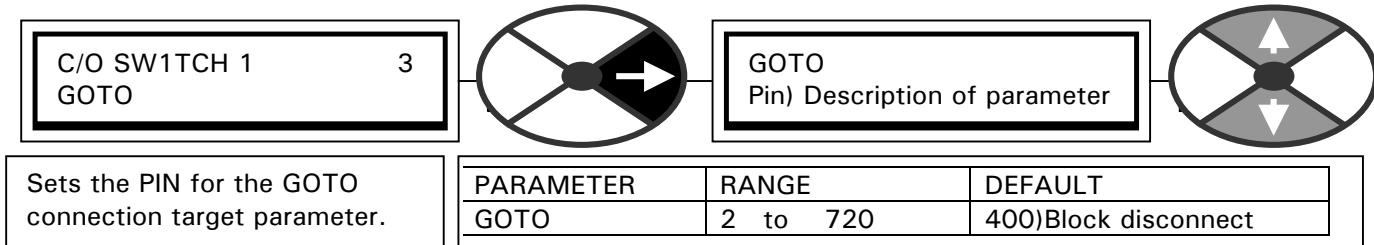

Sets the PIN for the GOTO connection target parameter.

Note. To activate the block the GOTO must be connected to a PIN other than 400)Block disconnect.

## 4 PIN table

Key to PROPERTIES. R=in REDUCED MENU, P=Not changed by 4-key reset. **Bolded PINs are more relevant for use within the PLA.** Unbolded PINs are less likely to be of use as these relate to the PL/X functioning.

### 4.1.1 Change parameters 2 - 121

Property	Paragraph PL/X man	Menu / Description	Range	Default	PIN
R/P	6.1.2	CALIBRATION / Rated armature amps PIN 2 QUICK START	33% -100%	33% Amps	2
R/P	6.1.3	CALIBRATION / Current limit% PIN 3 QUICK START	0 - 150.00%	150.00%	3
R/P	6.1.4	CALIBRATION / Rated field amps PIN 4 QUICK START	0.1 -100% A	25% Amps	4
R/P	6.1.5	CALIBRATION / Base rated motor rpm PIN 5 QUICK START	0 - 6000 rpm	1500 rpm	5
R/P	6.1.6	CALIBRATION / Desired max rpm PIN 6 QUICK START	0 - 6000 rpm	1500 rpm	6
R/P	6.1.7	CALIBRATION / Zero speed offset PIN 7	0 - +/-5.00%	0.00%	7
R/P	6.1.8	CALIBRATION / Max tach volts PIN 8	+/-200.00 V	60.00 V	8
R/P	6.1.9	CALIBRATION / Speed feedback type PIN 9 QUICK START	0, 1, 2, 3, 4	0 (AVF)	9
R/P	<b>6.1.10.1</b>	<b>ENCODER SCALING / Quadrature enable PIN 10</b>	<b>0 - 1</b>	<b>Disabled</b>	<b>10</b>
R/P	<b>6.1.10.2</b>	<b>ENCODER SCALING / Encoder lines PIN 11</b>	<b>1 - 6000</b>	<b>1000</b>	<b>11</b>
R/P	<b>6.1.10.3</b>	<b>ENCODER SCALING / Motor / encoder speed ratio PIN 12</b>	<b>0 - 3.0000</b>	<b>1.0000</b>	<b>12</b>
R/P	<b>6.1.10.4</b>	<b>ENCODER SCALING / Encoder sign PIN 13</b>	<b>0 - 1</b>	<b>Non-invert</b>	<b>13</b>
R/P	6.1.11	CALIBRATION / IR compensation PIN 14	0 - 100.00 %	0.00%	14
R/P	6.1.12	CALIBRATION / Field current feedback trim PIN 15	1 - 1.1000	1.0000	15
R/P	6.1.13	CALIBRATION / Armature volts trim PIN 16	1 - 1.1000	1.0000	16
R/P	6.1.14	CALIBRATION / Analog tach trim PIN 17	1 - 1.1000	1.0000	17
R/P	6.1.15	CALIBRATION / Rated armature volts PIN 18 QUICK START	0 - 1000.0 V	460.0 V	18
R/P	6.1.16	CALIBRATION / EL1/2/3 Rated AC volts PIN 19	0 - 1000.0 V	415.0 V	19
R/P	<b>6.1.17</b>	<b>CALIBRATION / MOTOR 1 or 2 select PIN 20</b>	<b>0 - 1</b>	<b>MOTOR 1</b>	<b>20</b>
R	6.2.2	RUN MODE RAMPS / Ramp output monitor PIN 21	+/-100.00%	0.00%	21
R	6.2.3	RUN MODE RAMPS / Forward up time PIN 22	0.1 - 600.0 s	10.0	22
R	6.2.4	RUN MODE RAMPS / Forward down time PIN 23	0.1 - 600.0 s	10.0	23
R	6.2.5	RUN MODE RAMPS / Reverse up time PIN 24	0.1 - 600.0 s	10.0	24
R	6.2.6	RUN MODE RAMPS / Reverse down time PIN 25	0.1 - 600.0 s	10.0	25
	6.2.7	RUN MODE RAMPS / Ramp input PIN 26	+/-105.00%	0.00%	26
	6.2.8	RUN MODE RAMPS / Forward minimum speed PIN 27	0 - 105.00%	0.00%	27
	6.2.9	RUN MODE RAMPS / Reverse minimum speed PIN 28	0 - -105.00%	0.00%	28
	6.2.10	RUN MODE RAMPS / Ramp automatic preset enable PIN 29	0 - 1	Enabled	29
	6.2.11	RUN MODE RAMPS / Ramp external preset enable PIN 30	0 - 1	Disabled	30
	6.2.12	RUN MODE RAMPS / Ramp preset value PIN 31	+/-300.00%	0.00%	31
	6.2.13	RUN MODE RAMPS / Ramp S profile % PIN 32	0.1- 100.00%	2.50%	32
	6.2.14	RUN MODE RAMPS / Ramp hold enable PIN 33	0 - 1	Disabled	33
	6.2.15	RUN MODE RAMPS / Ramping flag threshold PIN 34	0.1- 100.00%	0.50%	34
R	6.2.16	RUN MODE RAMPS / Ramping flag PIN 35	0 - 1	LOW	35
				0	36
R	6.3.2	JOG CRAWL SLACK / Jog speed 1 PIN 37	+/-100.00%	5.00%	37
R	6.3.2	JOG CRAWL SLACK / Jog speed 2 PIN 38	+/-100.00%	-5.00%	38
R	6.3.3	JOG CRAWL SLACK / Slack speed 1 PIN 39	+/-100.00%	5.00%	39
R	6.3.3	JOG CRAWL SLACK / Slack speed 2 PIN 40	+/-100.00%	-5.00%	40
R	6.3.4	JOG CRAWL SLACK / Crawl speed PIN 41	+/-100.00%	10.00%	41
R	6.3.5	JOG CRAWL SLACK / Jog mode select PIN 42	0 - 1	Disabled	42
R	6.3.6	JOG CRAWL SLACK / Jog/Slack ramp PIN 43	0.1 - 600.0 s	1.0 secs	43
				0	44
	6.4.2	MOTORISED POT RAMP / Motor pot output monitor PIN 45	+/-300.00%	0.00%	45
	6.4.3	MOTORISED POT RAMP / MP Up time PIN 46	0.1 - 600.0 s	10.0 secs	46
	6.4.3	MOTORISED POT RAMP / MP Down time PIN 47	0.1 - 600.0 s	10.0 secs	47
	6.4.4	MOTORISED POT RAMP / MP Up command PIN 48	0 - 1	Disabled	48
	6.4.4	MOTORISED POT RAMP / MP Down command PIN 49	0 - 1	Disabled	49
	6.4.5	MOTORISED POT RAMP / MP Maximum clamp PIN 50	+/-300.00%	100.00%	50
	6.4.5	MOTORISED POT RAMP / MP Minimum clamp PIN 51	+/-300.00%	-100.00%	51
	6.4.6	MOTORISED POT RAMP / MP preset enable PIN 52	0 - 1	Disabled	52
	6.4.7	MOTORISED POT RAMP / MP Preset value PIN 53	+/-300.00%	0.00%	53
	6.4.8	MOTORISED POT RAMP / MP memory boot up mode PIN 54	0 - 1	Disabled	54
				0	55
R	6.5.2	STOP MODE RAMP / Stop ramp time PIN 56	0.1 - 600.0 s	10.0 secs	56
	6.5.3	STOP MODE RAMP / Stop time limit PIN 57	0.0 - 600.0 s	60.0 secs	57

Property	Paragraph PL/X man	Menu / Description	Range	Default	PIN
	6.5.4	STOP MODE RAMP / Live delay mode PIN 58	0 - 1	Disabled	58
R	6.5.5	STOP MODE RAMP / Drop-out speed PIN 59	0 - 100.00%	2.00%	59
	6.5.6	STOP MODE RAMP / Drop-out delay PIN 60	0.1 - 600.0 s	1.0 secs	60
				0	61
R	6.6.2	SPEED REF SUMMER / Internal speed reference 1 PIN 62	+/-105.00%	0.00%	62
R	6.6.3	SPEED REF SUMMER / Auxiliary speed reference 2 PIN 63	+/-105.00%	0.00%	63
R	6.6.4	SPEED REF SUMMER / Speed / current reference 3 monitor PIN 64	+/-105.00%	0.00%	64
R	6.6.5	SPEED REF SUMMER / Ramped speed reference 4 PIN 65	+/-105.00%	0.00%	65
R	6.6.6	SPEED REF SUMMER / Speed/ Current reference 3 sign PIN 66	0 - 1	Non-invert	66
R	6.6.7	SPEED REF SUMMER / Speed/ Current reference 3 ratio PIN 67	+/-3.0000	1.0000	67
				0	68
R	6.7.2	SPEED CONTROL / Max+ speed reference PIN 69	0 - 105.00%	105.00%	69
R	6.7.3	SPEED CONTROL / Max- speed reference PIN 70	0 - -105.00%	-105.00%	70
R	6.7.4	SPEED CONTROL / Speed proportional gain PIN 71	0 - 200.00	15.00	71
R	6.7.5	SPEED CONTROL / Speed integral time constant PIN 72	.001-30.000s	1.000 s	72
	6.7.6	SPEED CONTROL / Speed integral reset PIN 73	0 - 1	Disabled	73
	6.7.7.1	SPEED PI ADAPTION / Low break point PIN 74	0 - 100.00%	1.00%	74
	6.7.7.2	SPEED PI ADAPTION / High break point PIN 75	0 - 100.00%	2.00%	75
	6.7.7.3	SPEED PI ADAPTION / Low point proportional gain PIN 76	0 - 200	5.00	76
	6.7.7.4	SPEED PI ADAPTION / Low integral time constant PIN 77	.001-30.000s	1.000 secs	77
	6.7.7.5	SPEED PI ADAPTION / Integral % during ramp PIN 78	0 - 100.00%	100.00%	78
	6.7.7.6	SPEED PI ADAPTION / Adapt input enable PIN 79	0 - 1	Enabled	79
				0	80
R	6.8.2	CURRENT CONTROL / Current clamp scaler PIN 81	0 - 150.00%	150.00%	81
S	6.8.3.1	CURRENT OVERLOAD / Overload % target value PIN 82	0 - 105.00%	105.00%	82
S	6.8.3.2	CURRENT OVERLOAD / Overload ramp time PIN 83	0 - 20.0 s	20.0 secs	83
	6.8.4.1	I DYNAMIC PROFILE / I Profile enable PIN 84	0 - 1	Disabled	84
	6.8.4.2	I DYNAMIC PROFILE / Speed break point at high current PIN 85	0 - 105.00%	75.00%	85
	6.8.4.3	I DYNAMIC PROFILE / Speed break point at low current PIN 86	0 - 105.00%	100.00%	86
	6.8.4.4	I DYNAMIC PROFILE / Current limit at low current PIN 87	0 - 150.00%	100.00%	87
	6.8.5	CURRENT CONTROL / Dual current clamps enable PIN 88	0 - 1	Disabled	88
	6.8.6	CURRENT CONTROL / Upper current clamp PIN 89	+/-100.00%	100.00%	89
	6.8.7	CURRENT CONTROL / Lower current clamp PIN 90	+/-100.00%	-100.00%	90
	6.8.8	CURRENT CONTROL / Extra current reference PIN 91	+/-300.00%	0.00%	91
S	6.8.9	CURRENT CONTROL / Autotune enable PIN 92	0 - 1	Disabled	92
R	6.8.10	CURRENT CONTROL / Current amp proportional gain PIN 93	0 - 200.00	30.00	93
R	6.8.11	CURRENT CONTROL / Current amp integral gain PIN 94	0 - 200.00	3.00	94
R	6.8.12	CURRENT CONTROL / Discontinuous current point PIN 95	0 - 200.00%	13.00%	95
R/S	6.8.13	CURRENT CONTROL / 4-quadrant mode enable PIN 96	0 - 1	Enabled	96
	6.8.14	CURRENT CONTROL / Speed bypass current demand enable PIN 97	0 - 1	Disabled	97
				0	98
R/S	6.9.2	FIELD CONTROL / Field enable PIN 99	0 - 1	Enabled	99
R/P	6.9.3	FIELD CONTROL / Voltage output % PIN 100	0 - 100.00%	90.00%	100
	6.9.4	FIELD CONTROL / Field proportional gain PIN 101	0 - 1000	10	101
	6.9.5	FIELD CONTROL / Field integral gain PIN 102	0 - 1000	100	102
S	6.9.6.1	WEAKENING MENU / Field weakening enable PIN 103	0 - 1	Disabled	103
	6.9.6.2	WEAKENING MENU / Field weakening proportional gain PIN 104	0 - 1000	50	104
	6.9.6.3	WEAKENING MENU / Field weakening integral TC PIN 105	0 - 20000 ms	4000 ms	105
	6.9.6.4	WEAKENING MENU / Field weakening derivative TC PIN 106	10 - 5000 ms	200 ms	106
	6.9.6.5	WEAKENING MENU / Field weakening feedback deriv TC PIN 107	10 - 5000 ms	100 ms	107
	6.9.6.6	WEAKENING MENU / Field weakening feedback int TC PIN 108	10 - 5000 ms	100 ms	108
	6.9.6.7	WEAKENING MENU / Spillover armature voltage % PIN 109	0 - 100.00%	100.00%	109
	6.9.6.8	WEAKENING MENU / Minimum field current % PIN 110	0 - 100.00%	10.00%	110
	6.9.7	FIELD CONTROL / Standby field enable PIN 111	0 - 1	Disabled	111
	6.9.8	FIELD CONTROL / Standby field value PIN 112	0 - 100.00%	25.00%	112
	6.9.9	FIELD CONTROL / Field quench delay PIN 113	0 - 600.0 s	10.0 secs	113
	6.9.10	FIELD CONTROL / Field reference PIN 114	0 - 100.00%	100.00%	114
R	6.10.2	ZERO INTERLOCKS / Standstill enable PIN 115	0 - 1	Disabled	115
	6.10.3	ZERO INTERLOCKS / Zero reference start enable PIN 116	0 - 1	Disabled	116
R	6.10.4	ZERO INTERLOCKS / Zero interlocks speed level PIN 117	0 - 100.00%	1.00%	117
R	6.10.5	ZERO INTERLOCKS / Zero interlocks current level PIN 118	0 - 100.00%	1.50%	118
	6.10.6	ZERO INTERLOCKS / At zero reference flag PIN 119	0 - 1	Low	119
	6.10.7	ZERO INTERLOCKS / At zero speed flag PIN 120	0 - 1	Low	120
	6.10.8	ZERO INTERLOCKS / At standstill flag PIN 121	0 - 1	Low	121
S	6.10.9.2	SPINDLE ORIENTATE / Zero speed lock PIN 122	0 - 100.00	0.00	122

## 4.1.2 Diagnostics and alarms 123 - 183

Property	Paragraph PL/X man	Menu / Description	Range	Default	PIN
R	7.1.1	SPEED LOOP MONITOR / Total speed reference monitor PIN 123	+/-300.00%	0.00%	123
	7.1.2	SPEED LOOP MONITOR / Speed demand monitor PIN 124	+/-300.00%	0.00%	124
	7.1.3	SPEED LOOP MONITOR / Speed error monitor PIN 125	+/-300.00%	0.00%	125
R	7.1.4	<b>SPEED LOOP MONITOR / Armature volts monitor PIN 126</b>	<b>+/-1250.0V</b>	<b>0.0 V</b>	<b>126</b>
	7.1.5	SPEED LOOP MONITOR / Armature volts % monitor PIN 127	+/-300.00%	0.00%	127
	7.1.6	SPEED LOOP MONITOR / Back emf % monitor PIN 128	+/-300.00%	0.00%	128
R	7.1.7	<b>SPEED LOOP MONITOR / Tachogenerator volts monitor PIN 129</b>	<b>+/-220.00 V</b>	<b>0.00 V</b>	<b>129</b>
R	7.1.8	SPEED LOOP MONITOR / Motor RPM monitor PIN 130	+/- 7500 rpm	0 rpm	130
R	7.1.10	SPEED LOOP MONITOR / Speed feedback % monitor PIN 131	+/-300.00%	0.00%	131
R	7.1.9	<b>SPEED LOOP MONITOR / Encoder RPM monitor PIN 132</b>	<b>+/- 7500 rpm</b>	<b>0 rpm</b>	<b>132</b>
R	7.2.1	ARM I LOOP MONITOR / Arm current demand monitor PIN 133	+/- 150.00%	0.00%	133
R	7.2.2	ARM I LOOP MONITOR / Arm current % monitor PIN 134	+/- 150.00%	0.00%	134
R	7.2.3	ARM I LOOP MONITOR / Arm current amps monitor PIN 135	+/-3000.0 A	0.00 Amps	135
	7.2.4	ARM I LOOP MONITOR / Upper current limit monitor PIN 136	+/-150.00%	0.00%	136
	7.2.5	ARM I LOOP MONITOR / Lower current limit monitor PIN 137	+/-150.00%	0.00%	137
R	7.2.6	ARM I LOOP MONITOR / Actual upper limit monitor PIN 138	+/-150.00%	0.00%	138
R	7.2.6	ARM I LOOP MONITOR / Actual lower limit monitor PIN 139	+/-150.00%	0.00%	139
	7.2.7	ARM I LOOP MONITOR / Overload limit monitor PIN 140	0 -150.00%	0.00%	140
	7.2.8	ARM I LOOP MONITOR / At current limit flag PIN 141	0 - 1	Low	141
				0	142
R	7.3.1	FIELD MONITOR / Field demand monitor PIN 143	0 -100.00%	0.00%	143
R	7.3.2	FIELD MONITOR / Field current % monitor PIN 144	0 -125.00%	0.00%	144
R	7.3.3	FIELD MONITOR / Field amps monitor PIN 145	0 - 50.00 A	0.00 Amps	145
	7.3.4	FIELD MONITOR / Field firing angle monitor PIN 146	0 - 155 Deg	0 Deg	146
	7.3.5	FIELD MONITOR / Field active monitor PIN 147	0 - 1	disabled	147
				0	148
				0	149
R	7.4.1	<b>ANALOG IO MONITOR / UIP2 analogue input monitor PIN 150</b>	<b>+/- 30.730</b>	<b>0.000 V</b>	<b>150</b>
R	7.4.1	<b>ANALOG IO MONITOR / UIP3 analogue input monitor PIN 151</b>	<b>+/- 30.730</b>	<b>0.000 V</b>	<b>151</b>
R	7.4.1	<b>ANALOG IO MONITOR / UIP4 analogue input monitor PIN 152</b>	<b>+/- 30.730</b>	<b>0.000 V</b>	<b>152</b>
	7.4.1	<b>ANALOG IO MONITOR / UIP5 analogue input monitor PIN 153</b>	<b>+/- 30.730</b>	<b>0.000 V</b>	<b>153</b>
	7.4.1	<b>ANALOG IO MONITOR / UIP6 analogue input monitor PIN 154</b>	<b>+/- 30.730</b>	<b>0.000 V</b>	<b>154</b>
	7.4.1	<b>ANALOG IO MONITOR / UIP7 analogue input monitor PIN 155</b>	<b>+/- 30.730</b>	<b>0.000 V</b>	<b>155</b>
	7.4.1	<b>ANALOG IO MONITOR / UIP8 analogue input monitor PIN 156</b>	<b>+/- 30.730</b>	<b>0.000 V</b>	<b>156</b>
	7.4.1	<b>ANALOG IO MONITOR / UIP9 analogue input monitor PIN 157</b>	<b>+/- 30.730</b>	<b>0.000 V</b>	<b>157</b>
				0	158
	7.4.2	<b>ANALOG IO MONITOR / AOP1 analogue output monitor PIN 159</b>	<b>+/-11.300 V</b>	<b>0.000 V</b>	<b>159</b>
	7.4.2	<b>ANALOG IO MONITOR / AOP2 analogue output monitor PIN 160</b>	<b>+/-11.300 V</b>	<b>0.000 V</b>	<b>160</b>
	7.4.2	<b>ANALOG IO MONITOR / AOP3 analogue output monitor PIN 161</b>	<b>+/-11.300 V</b>	<b>0.000 V</b>	<b>161</b>
R	7.5.1	<b>DIGITAL IO MONITOR / UIP2 to 9 digital input monitor PIN 162</b>	<b>0/1 times 8</b>	<b>00000000</b>	<b>162</b>
R	7.5.2	<b>DIGITAL IO MONITOR / DIP1-4 and DIO1-4 dig IP monitor PIN 163</b>	<b>0/1 times 8</b>	<b>00000000</b>	<b>163</b>
R	7.5.3	DIGITAL IO MONITOR / DOP1-3 + Control IPs dig OP mon PIN 164	0/1 times 8	00000000	164
	7.5.4	DIGITAL IO MONITOR / + Armature bridge flag PIN 165	0 - 1	Low	165
R	7.5.5	DIGITAL IO MONITOR / Drive start flag PIN 166	0 - 1	Low	166
R	7.5.6	DIGITAL IO MONITOR / Drive run flag PIN 167	0 - 1	Low	167
R	7.5.7	DIGITAL IO MONITOR / Internal running mode monitor PIN 168	1 of 8 modes	Stop	168
R	7.7	<b>DIAGNOSTICS / EL1/2/3 RMS monitor PIN 169</b>	<b>0- 1000.0 V</b>	<b>0.0 V</b>	<b>169</b>
R	7.8	DIAGNOSTICS / DC KILOWATTS monitor PIN 169	+/-3000.0Kw	0.0	170
R	8.1.1	MOTOR DRIVE ALARMS / Speed fb mismatch trip enable PIN 171	0 - 1	Enabled	171
	8.1.2	MOTOR DRIVE ALARMS / Speed fb mismatch tolerance PIN 172	0 -100.00%	50.00%	172
R	8.1.3	MOTOR DRIVE ALARMS / Field loss trip disable PIN 173	0 - 1	Enabled	173
	8.1.4	MOTOR DRIVE ALARMS / Dig OP short circuit trip enable PIN 174	0 - 1	Disabled	174
	8.1.5	MOTOR DRIVE ALARMS / Missing pulse trip enable PIN 175	0 - 1	Enabled	175
	8.1.6	MOTOR DRIVE ALARMS / Reference exchange trip enable PIN 176	0 - 1	Disabled	176
	8.1.7	MOTOR DRIVE ALARMS / Overspeed delay time PIN 177	0.1 - 600.0 s	5.00 secs	177
R	8.1.8.1	STALL TRIP MENU / Stall trip enable PIN 178	0 - 1	Enabled	178
R	8.1.8.2	STALL TRIP MENU / Stall current level PIN 179	0 -150.00%	95.00%	179
R	8.1.8.3	STALL TRIP MENU / Stall delay time PIN 180	0.1 - 600.0 s	10.0 secs	180
	8.1.9	MOTOR DRIVE ALARMS / Active trip monitor PIN 181	0000 - FFFF	0000	181
	8.1.9	MOTOR DRIVE ALARMS / Stored trip monitor PIN 182	0000 - FFFF	0	182
	8.1.10	MOTOR DRIVE ALARMS / External trip reset enable PIN 183	0 - 1	Enabled	183

## 4.1.3 Serial links 187 - 249

Property	Paragraph PL/X man	Menu / Description	Range	Default	PIN
				0	184
				0	185
				0	186
R/S	10.1.2	RS232 PORT1 / Port1 Baud rate PIN 187	300 - 57600	9600	187
S	10.1.3	PORT1 FUNCTION / Port1 function mode PIN 188	1 of 4 modes	Param exch	188
	10.3.1	PORT1 REF EXCHANGE / Ref exchange slave ratio PIN 189	+/-3.0000	1.0000	189
	10.3.2	PORT1 REF EXCHANGE / Ref exchange slave sign PIN 190	0 - 1	Non-invert	190
	10.3.3	PORT1 REF EXCHANGE / Ref exchange slave monitor PIN 191	+/-300.00%	0.00%	191
	10.3.4	PORT1 REF EXCHANGE / Ref exchange master monitor PIN 192	+/-300.00%	0.00%	192
	10.2.5	PORT 1 COMMS LINK / Port 1 group ID PIN 193	0 - 7	0	193
	10.2.5	PORT 1 COMMS LINK / Port 1 unit ID PIN 194	0 - 15	0	194
	10.2.5	PORT 1 COMMS LINK / Port 1 error code PIN 195	1 - 8	1	195
S	10.2.5	PORT 1 COMMS LINK / Port 1 DOP3 RTS mode PIN 196	0 - 1	Disabled	196
					197
					198
	Serial Comms	FIELD BUS CONFIG / Fieldbus data control PIN 199	00 - 11	00	199
		FBUS ON-LINE MON (Hidden pin)	0 - 1	Low	200
					201
					202
		RESERVED			203 to 239
	6.10.9.3	SPINDLE ORIENTATE / Marker enable PIN 240	0 - 1	Disabled	240
	6.10.9.4	SPINDLE ORIENTATE / Marker offset PIN 241	+/-15,000	0	241
	6.10.9.5	SPINDLE ORIENTATE / Position reference PIN 242	+/-30,000	0	242
	6.10.9.6	SPINDLE ORIENTATE / Marker frequency monitor PIN 243	20-655.37 Hz	0 Hz	243
	6.10.9.7	SPINDLE ORIENTATE / In position flag PIN 244	0 - 1	Low	244

## 4.1.4 Configuration 251 - 400

Property	Paragraph	Menu / Description	Range	Default	PIN
	13.4.1	ANALOG OUTPUTS / Iarm o/p rectify enable PIN 250	0 - 1	Disabled	250
	13.4.2.1	AOP1 (T10) SETUP / AOP1 Dividing factor PIN 251	+/- 3.0000	1.0000	251
	13.4.2.2	AOP1 (T10) SETUP / AOP1 Offset PIN 252	+/-100.00%	0.00%	252
	13.4.2.3	AOP1 (T10) SETUP / AOP1 Rectifier mode enable PIN 253	0 - 1	Disabled	253
	13.4.2.1	AOP2 (T11) SETUP / AOP2 Dividing factor PIN 254	+/- 3.0000	1.0000	254
	13.4.2.2	AOP2 (T11) SETUP / AOP2 Offset PIN 255	+/-100.00%	0.00%	255
	13.4.2.3	AOP2 (T11) SETUP / AOP2 Rectifier mode enable PIN 256	0 - 1	Disabled	256
	13.4.2.1	AOP3 (T12) SETUP / AOP3 Dividing factor PIN 257	+/- 3.0000	1.0000	257
	13.4.2.2	AOP3 (T12) SETUP / AOP3 Offset PIN 258	+/-100.00%	0.00%	258
	13.4.2.3	AOP3 (T13) SETUP / AOP3 Rectifier mode enable PIN 259	0 - 1	Disabled	259
	13.4.3	ANALOG OUTPUTS / Scope output select on AOP3 PIN 260	0 - 1	Disabled	260
	13.7.1.1	DOP1 (T22) SETUP / DOP1 Output value rectifier enable PIN 261	0 - 1	Enabled	261
	13.7.1.2	DOP1 (T22) SETUP / DOP1 OP comparator threshold . PIN 262	+/-300.00%	0.00%	262
	13.7.1.3	DOP1 (T22) SETUP / DOP1 Output inversion mode PIN 263	0 - 1	Non invert	263
	13.7.1.1	DOP2 (T23) SETUP / DOP2 Output value rectifier enable PIN 264	0 - 1	Enabled	264
	13.7.1.2	DOP2 (T23) SETUP / DOP2 OP comparator threshold PIN 265	+/-300.00%	0.00%	265
	13.7.1.3	DOP2 (T23) SETUP / DOP2 Output inversion mode PIN 266	0 - 1	Non invert	266
	13.7.1.1	DOP3 (T24) SETUP / DOP3 Output value rectifier enable PIN 267	0 - 1	Enabled	267
	13.7.1.2	DOP3 (T24) SETUP / DOP3 OP comparator threshold PIN 268	+/-300.00%	0.00%	268
	13.7.1.3	DOP3 (T24) SETUP / DOP3 Output inversion mode PIN 269	0 - 1	Non invert	269
				0	270
S	13.6.1.1	DIO1 (T18) SETUP / DIO1 Output mode enable PIN 271	0 - 1	Disabled	271
	13.6.1.2	DIO1 (T18) SETUP / DIO1 Output value rectify enable PIN 272	0 - 1	Enabled	272
	13.6.1.3	DIO1 (T18) SETUP / DIO1 OP comparator threshold PIN 273	+/-300.00%	0.00%	273
	13.6.1.4	DIO1 (T18) SETUP / DIO1 Output inversion mode PIN 274	0 - 1	Non invert	274
	13.6.1.7	DIO1 (T18) SETUP / DIO1 Input high value PIN 275	+/-300.00%	0.01%	275
	13.6.1.8	DIO1 (T18) SETUP / DIO1 Input low value PIN 276	+/-300.00%	0.00%	276
S	13.6.1.1	DIO2 (T19) SETUP / DIO2 Output mode enable PIN 277	0 - 1	Disabled	277
	13.6.1.2	DIO2 (T19) SETUP / DIO2 Output value rectify enable PIN 278	0 - 1	Enabled	278
	13.6.1.3	DIO2 (T19) SETUP / DIO2 OP comparator threshold PIN 279	+/-300.00%	0.00%	279



Property	Paragraph PL/X man	Menu / Description	Range	Default	PIN
	13.6.1.4	DIO2 (T19) SETUP / DIO2 Output inversion mode PIN 280	0 - 1	Non invert	280
	13.6.1.7	DIO2 (T19) SETUP / DIO2 Input high value PIN 281	+/-300.00%	0.01%	281
	13.6.1.8	DIO2 (T19) SETUP / DIO2 Input low value PIN 282	+/-300.00%	0.00%	282
S	13.6.1.1	DIO3 (T20) SETUP / DIO3 Output mode enable PIN 283	0 - 1	Disabled	283
	13.6.1.2	DIO3 (T20) SETUP / DIO3 Output value rectify enable PIN 284	0 - 1	Enabled	284
	13.6.1.3	DIO3 (T20) SETUP / DIO3 OP comparator threshold PIN 285	+/-300.00%	0.00%	285
	13.6.1.4	DIO3 (T20) SETUP / DIO3 Output inversion mode PIN 286	0 - 1	Non invert	286
	13.6.1.7	DIO3 (T20) SETUP / DIO3 Input high value PIN 287	+/-300.00%	0.01%	287
	13.6.1.8	DIO3 (T20) SETUP / DIO3 Input low value PIN 288	+/-300.00%	0.00%	288
S	13.6.1.1	DIO4 (T21) SETUP / DIO4 Output mode enable PIN 289	0 - 1	Disabled	289
	13.6.1.2	DIO4 (T21) SETUP / DIO4 Output value rectify enable PIN 290	0 - 1	Enabled	290
	13.6.1.3	DIO4 (T21) SETUP / DIO4 OP comparator threshold PIN 291	+/-300.00%	0.00%	291
	13.6.1.4	DIO4 (T21) SETUP / DIO4 Output inversion mode PIN 292	0 - 1	Non invert	292
	13.6.1.7	DIO4 (T21) SETUP / DIO4 Input high value PIN 293	+/-300.00%	0.01%	293
	13.6.1.8	DIO4 (T21) SETUP / DIO4 Input low value PIN 294	+/-300.00%	0.00%	294
				0	295
	13.8.2	STAGING POSTS / Digital post 1 PIN 296	0 - 1	Low	296
	13.8.2	STAGING POSTS / Digital post 2 PIN 297	0 - 1	Low	297
	13.8.2	STAGING POSTS / Digital post 3 PIN 298	0 - 1	Low	298
	13.8.2	STAGING POSTS / Digital post 4 PIN 299	0 - 1	Low	299
	13.8.2	STAGING POSTS / Analog post 1 PIN 300	+/-300.00%	0.00%	300
	13.8.2	STAGING POSTS / Analog post 2 PIN 301	+/-300.00%	0.00%	301
	13.8.2	STAGING POSTS / Analog post 3 PIN 302	+/-300.00%	0.00%	302
	13.8.2	STAGING POSTS / Analog post 4 PIN 303	+/-300.00%	0.00%	303
				0	304
	13.9.1	SOFTWARE TERMINALS / Anded run PIN 305	0 - 1	High	305
	13.9.2	SOFTWARE TERMINALS / Anded jog PIN 306	0 - 1	High	306
	13.9.3	SOFTWARE TERMINALS / Anded start PIN 307	0 - 1	High	307
	13.9.4	SOFTWARE TERMINALS / Internal run PIN 308	0 - 1	Low	308
				0	309
	13.5.2.1	DIP1 (T14) SETUP / DIP1 Input high value PIN 310	+/-300.00%	0.01%	310
	13.5.2.2	DIP1 (T14) SETUP / DIP1 Input low value PIN 311	+/-300.00%	0.00%	311
	13.5.2.1	DIP2 (T15) SETUP / DIP2 Input high value PIN 312	+/-300.00%	0.01%	312
	13.5.2.2	DIP2 (T15) SETUP / DIP2 Input low value PIN 313	+/-300.00%	0.00%	313
	13.5.2.1	DIP3 (T16) SETUP / DIP3 Input high value PIN 314	+/-300.00%	0.01%	314
	13.5.2.2	DIP3 (T16) SETUP / DIP3 Input low value PIN 315	+/-300.00%	0.00%	315
	13.5.2.1	DIP4 (T17) SETUP / DIP4 Input high value PIN 316	+/-300.00%	0.01%	316
	13.5.2.2	DIP4 (T17) SETUP / DIP4 Input low value PIN 317	+/-300.00%	0.00%	317
	13.5.3.1	RUN INPUT SETUP / RUN input HI value PIN 318	+/-300.00%	0.01%	318
	13.5.3.2	RUN INPUT SETUP / RUN input LO value PIN 319	+/-300.00%	0.00%	319
	13.3.1.1	UIP2 (T2) SETUP / UIP2 Input range PIN 320	1 of 4 ranges	10V range	320
	13.3.1.2	UIP2 (T2) SETUP / UIP2 Input offset PIN 321	+/-100.00%	0.00%	321
	13.3.1.3	UIP2 (T2) SETUP / UIP2 Linear scaling factor PIN 322	+/-3.0000	1.0000	322
	13.3.1.4	UIP2 (T2) SETUP / UIP2 Max clamp level PIN 323	+/-300.00%	100.00%	323
	13.3.1.5	UIP2 (T2) SETUP / UIP2 Min clamp level PIN 324	+/-300.00%	-100.00%	324
	13.3.1.9	UIP2 (T2) SETUP / UIP2 Digital IP, high value for output 1 PIN 325	+/-300.00%	0.01%	325
	13.3.1.10	UIP2 (T2) SETUP / UIP2 Digital IP, low value for output 1 PIN 326	+/-300.00%	0.00%	326
	13.3.1.11	UIP2 (T2) SETUP / UIP2 Digital IP, high value for output 2 PIN 327	+/-300.00%	0.01%	327
	13.3.1.12	UIP2 (T2) SETUP / UIP2 Digital IP, low value for output 2 PIN 328	+/-300.00%	0.00%	328
	13.3.1.13	UIP2 (T2) SETUP / UIP2 Threshold PIN 329	+/-30.000 V	6.000V	329
	13.3.1.1	UIP3 (T3) SETUP / UIP3 Input range PIN 330	1 of 4 ranges	10V range)	330
	13.3.1.2	UIP3 (T3) SETUP / UIP3 Input offset PIN 331	+/-100.00%	0.00%	331
	13.3.1.3	UIP3 (T3) SETUP / UIP3 Linear scaling factor PIN 332	+/-3.0000	1.0000	332
	13.3.1.4	UIP3 (T3) SETUP / UIP3 Max clamp level PIN 333	+/-300.00%	100.00%	333
	13.3.1.5	UIP3 (T3) SETUP / UIP3 Min clamp level PIN 334	+/-300.00%	-100.00%	334
	13.3.1.9	UIP3 (T3) SETUP / UIP3 Digital IP, high value for output 1 PIN 335	+/-300.00%	0.01%	335
	13.3.1.10	UIP3 (T3) SETUP / UIP3 Digital IP, low value for output 1 PIN 336	+/-300.00%	0.00%	336
	13.3.1.11	UIP3 (T3) SETUP / UIP3 Digital IP, high value for output 2 PIN 337	+/-300.00%	0.01%	337
	13.3.1.12	UIP3 (T3) SETUP / UIP3 Digital IP, low value for output 2 PIN 338	+/-300.00%	0.00%	338
	13.3.1.13	UIP3 (T3) SETUP / UIP3 Threshold PIN 339	+/-30.000 V	6.000V	339
	13.3.1.1	UIP4 (T4) SETUP / UIP4 Input range PIN 340	1 of 4 ranges	10V range	340
	13.3.1.2	UIP4 (T4) SETUP / UIP4 Input offset PIN 341	+/-100.00%	0.00%	341
	13.3.1.3	UIP4 (T4) SETUP / UIP4 Linear scaling factor PIN 342	+/-3.0000	1.0000	342
	13.3.1.4	UIP4 (T4) SETUP / UIP4 Max clamp level PIN 343	+/-300.00%	100.00%	343
	13.3.1.5	UIP4 (T4) SETUP / UIP4 Min clamp level PIN 344	+/-300.00%	-100.00%	344
	13.3.1.9	UIP4 (T4) SETUP / UIP4 Digital IP, high value for output 1 PIN 345	+/-300.00%	0.01%	345

Property	Paragraph PL/X man	Menu / Description	Range	Default	PIN
	13.3.1.10	UIP4 (T4) SETUP / UIP4 Digital IP, low value for output 1 PIN 346	+/-300.00%	0.00%	346
	13.3.1.11	UIP4 (T4) SETUP / UIP4 Digital IP, high value for output 2 PIN 347	+/-300.00%	0.01%	347
	13.3.1.12	UIP4 (T4) SETUP / UIP4 Digital IP, low value for output 2 PIN 348	+/-300.00%	0.00%	348
	13.3.1.13	UIP4 (T4) SETUP / UIP4 Threshold PIN 349	+/-30.000 V	6.000V	349
	13.3.1.1	UIP5 (T5) SETUP / UIP5 Input range PIN 350	1 of 4 ranges	10V range	350
	13.3.1.2	UIP5 (T5) SETUP / UIP5 Input offset PIN 351	+/-100.00%	0.00%	351
	13.3.1.3	UIP5 (T5) SETUP / UIP5 Linear scaling factor PIN 352	+/-3.0000	1.0000	352
	13.3.1.4	UIP5 (T5) SETUP / UIP5 Max clamp level PIN 353	+/-300.00%	100.00%	353
	13.3.1.5	UIP5 (T5) SETUP / UIP5 Min clamp level PIN 354	+/-300.00%	-100.00%	354
	13.3.1.9	UIP5 (T5) SETUP / UIP5 Digital IP, high value for output 1 PIN 355	+/-300.00%	0.01%	355
	13.3.1.10	UIP5 (T5) SETUP / UIP5 Digital IP, low value for output 1 PIN 356	+/-300.00%	0.00%	356
	13.3.1.11	UIP5 (T5) SETUP / UIP5 Digital IP, high value for output 2 PIN 357	+/-300.00%	0.01%	357
	13.3.1.12	UIP5 (T5) SETUP / UIP5 Digital IP, low value for output 2 PIN 358	+/-300.00%	0.00%	358
	13.3.1.13	UIP5 (T5) SETUP / UIP5 Threshold PIN 359	+/-30.000 V	6.000V	359
	13.3.1.1	UIP6 (T6) SETUP / UIP6 Input range PIN 360	1 of 4 ranges	10V range	360
	13.3.1.2	UIP6 (T6) SETUP / UIP6 Input offset PIN 361	+/-100.00%	0.00%	361
	13.3.1.3	UIP6 (T6) SETUP / UIP6 Linear scaling factor PIN 362	+/-3.0000	1.0000	362
	13.3.1.4	UIP6 (T6) SETUP / UIP6 Max clamp level PIN 363	+/-300.00%	100.00%	363
	13.3.1.5	UIP6 (T6) SETUP / UIP6 Min clamp level PIN 364	+/-300.00%	-100.00%	364
	13.3.1.9	UIP6 (T6) SETUP / UIP6 Digital IP, high value for output 1 PIN 365	+/-300.00%	0.01%	365
	13.3.1.10	UIP6 (T6) SETUP / UIP6 Digital IP, low value for output 1 PIN 366	+/-300.00%	0.00%	366
	13.3.1.11	UIP6 (T6) SETUP / UIP6 Digital IP, high value for output 2 PIN 367	+/-300.00%	0.01%	367
	13.3.1.12	UIP6 (T6) SETUP / UIP6 Digital IP, low value for output 2 PIN 368	+/-300.00%	0.00%	368
	13.3.1.13	UIP6 (T6) SETUP / UIP6 Threshold PIN 369	+/-30.000 V	6.000V	369
	13.3.1.1	UIP7 (T7) SETUP / UIP7 Input range PIN 370	1 of 4 ranges	10V range	370
	13.3.1.2	UIP7 (T7) SETUP / UIP7 Input offset PIN 371	+/-100.00%	0.00%	371
	13.3.1.3	UIP7 (T7) SETUP / UIP7 Linear scaling factor PIN 372	+/-3.0000	1.0000	372
	13.3.1.4	UIP7 (T7) SETUP / UIP7 Max clamp level PIN 373	+/-300.00%	100.00%	373
	13.3.1.5	UIP7 (T7) SETUP / UIP7 Min clamp level PIN 374	+/-300.00%	-100.00%	374
	13.3.1.9	UIP7 (T7) SETUP / UIP7 Digital IP, high value for output 1 PIN 375	+/-300.00%	0.01%	375
	13.3.1.10	UIP7 (T7) SETUP / UIP7 Digital IP, low value for output 1 PIN 376	+/-300.00%	0.00%	376
	13.3.1.11	UIP7 (T7) SETUP / UIP7 Digital IP, high value for output 2 PIN 377	+/-300.00%	0.01%	377
	13.3.1.12	UIP7 (T7) SETUP / UIP7 Digital IP, low value for output 2 PIN 378	+/-300.00%	0.00%	378
	13.3.1.13	UIP7 (T7) SETUP / UIP7 Threshold PIN 379	+/-30.000 V	6.000V	379
	13.3.1.1	UIP8 (T8) SETUP / UIP8 Input range PIN 380	1 of 4 ranges	10V range	380
	13.3.1.2	UIP8 (T8) SETUP / UIP8 Input offset PIN 381	+/-100.00%	0.00%	381
	13.3.1.3	UIP8 (T8) SETUP / UIP8 Linear scaling factor PIN 382	+/-3.0000	1.0000	382
	13.3.1.4	UIP8 (T8) SETUP / UIP8 Max clamp level PIN 383	+/-300.00%	100.00%	383
	13.3.1.5	UIP8 (T8) SETUP / UIP8 Min clamp level PIN 384	+/-300.00%	-100.00%	384
	13.3.1.9	UIP8 (T8) SETUP / UIP8 Digital IP, high value for output 1 PIN 385	+/-300.00%	0.01%	385
	13.3.1.10	UIP8 (T8) SETUP / UIP8 Digital IP, low value for output 1 PIN 386	+/-300.00%	0.00%	386
	13.3.1.11	UIP8 (T8) SETUP / UIP8 Digital IP, high value for output 2 PIN 387	+/-300.00%	0.01%	387
	13.3.1.12	UIP8 (T8) SETUP / UIP8 Digital IP, low value for output 2 PIN 388	+/-300.00%	0.00%	388
	13.3.1.13	UIP8 (T8) SETUP / UIP8 Threshold PIN 389	+/-30.000 V	6.000V	389
	13.3.1.1	UIP9 (T9) SETUP / UIP9 Input range PIN 390	1 of 4 ranges	10V range	390
	13.3.1.2	UIP9 (T9) SETUP / UIP9 Input offset PIN 391	+/-100.00%	0.00%	391
	13.3.1.3	UIP9 (T9) SETUP / UIP9 Linear scaling factor PIN 392	+/-3.0000	1.0000	392
	13.3.1.4	UIP9 (T9) SETUP / UIP9 Max clamp level PIN 393	+/-300.00%	100.00%	393
	13.3.1.5	UIP9 (T9) SETUP / UIP9 Min clamp level PIN 394	+/-300.00%	-100.00%	394
	13.3.1.9	UIP9 (T9) SETUP / UIP9 Digital IP, high value for output 1 PIN 395	+/-300.00%	0.01%	395
	13.3.1.10	UIP9 (T9) SETUP / UIP9 Digital IP, low value for output 1 PIN 396	+/-300.00%	0.00%	396
	13.3.1.11	UIP9 (T9) SETUP / UIP9 Digital IP, high value for output 2 PIN 397	+/-300.00%	0.01%	397
	13.3.1.12	UIP9 (T9) SETUP / UIP9 Digital IP, low value for output 2 PIN 398	+/-300.00%	0.00%	398
	13.3.1.13	UIP9 (T9) SETUP / UIP9 Threshold PIN 399	+/-30.000 V	6.000V	399
	13.2.5	Block disconnect PIN 400			400

#### 4.1.5 Application blocks 401 - 680

All application block PINs are relevant.

Property	Paragraph PLA man	Menu / Description	Range	Default	PIN
		Block disconnect			400
	3.2.2	SUMMER 1 / Total output value monitor PIN 401	+/-200.00%	0.00%	401
	3.2.3	SUMMER 1 / Sign 1 PIN 402	0 - 1	Non-invert	402
	3.2.4	SUMMER 1 / Sign 2 PIN 403	0 - 1	Non-invert	403

	3.2.5	SUMMER 1 / Ratio 1 PIN 404	+/-3.0000	1.0000	404
	3.2.6	SUMMER 1 / Ratio 2 PIN 405	+/-3.0000	1.0000	405
	3.2.7	SUMMER 1 / Divider 1 PIN 406	+/-3.0000	1.0000	406
	3.2.8	SUMMER 1 / Divider 2 PIN 407	+/-3.0000	1.0000	407
	3.2.9	SUMMER 1 / Input 1 PIN 408	+/-300.00%	0.00%	408
	3.2.10	SUMMER 1 / Input 2 PIN 409	+/-300.00%	0.00%	409
	3.2.11	SUMMER 1 / Input 3 PIN 410	+/-300.00%	0.00%	410
	3.2.12	SUMMER 1 / Deadband PIN 411	0 - 100.00%	0.00%	411
	3.2.13	SUMMER 1 / Output sign inverter PIN 412	0 - 1	Non-invert	412
	3.2.14	SUMMER 1 / Symmetrical clamp PIN 413	0 - 200.00%	105.00%	413
					414
	3.2.2	SUMMER 2 / Total output value monitor PIN 415	+/-200.00%	0.00%	415
	3.2.3	SUMMER 2 / Sign 1 PIN 416	0 - 1	Non-invert	416
	3.2.4	SUMMER 2 / Sign 2 PIN 417	0 - 1	Non-invert	417
	3.2.5	SUMMER 2 / Ratio 1 PIN 418	+/-3.0000	1.0000	418
	3.2.6	SUMMER 2 / Ratio 2 PIN 419	+/-3.0000	1.0000	419
	3.2.7	SUMMER 2 / Divider 1 PIN 420	+/-3.0000	1.0000	420
	3.2.8	SUMMER 2 / Divider 2 PIN 421	+/-3.0000	1.0000	421
	3.2.9	SUMMER 2 / Input 1 PIN 422	+/-300.00%	0.00%	422
	3.2.10	SUMMER 2 / Input 2 PIN 423	+/-300.00%	0.00%	423
	3.2.11	SUMMER 2 / Input 3 PIN 424	+/-300.00%	0.00%	424
	3.2.12	SUMMER 2 / Deadband PIN 425	0 - 100.00%	0.00%	425
	3.2.13	SUMMER 2 / Output sign inverter PIN 426	0 - 1	Non-invert	426
	3.2.14	SUMMER 2 / Symmetrical clamp PIN 427	0 - 200.00%	105.00%	427
				0	428
	3.3.2	PID 1 / Pid1 output value monitor PIN 429	+/-300.00%	0.00%	429
	3.3.3	PID 1 / Pid1 IP1 value PIN 430	+/-300.00%	0.00%	430
	3.3.4	PID 1 / Pid1 IP1 ratio PIN 431	+/-3.0000	1.0000	431
	3.3.5	PID 1 / Pid1 IP1 divider PIN 432	+/-3.0000	1.0000	432
	3.3.6	PID 1 / Pid1 IP2 value PIN 433	+/-300.00%	0.00%	433
	3.3.7	PID 1 / Pid1 IP2 ratio PIN 434	+/-3.0000	1.0000	434
	3.3.8	PID 1 / Pid1 IP2 divider PIN 435	+/-3.0000	1.0000	435
	3.3.9	PID 1 / Pid1 proportional gain PIN 436	0.0 - 100.0	1.0	436
	3.3.10	PID 1 / Pid1 integrator time constant PIN 437	.01-100.00 s	5.00 secs	437
	3.3.11	PID 1 / Pid1 derivative time constant PIN 438	0 - 10.000s	0.000 secs	438
	3.3.12	PID 1 / Pid1 derivative filter time constant PIN 439	0 - 10.000s	0.100 secs	439
	3.3.13	PID 1 / Pid1 integrator preset enable PIN 440	0 - 1	Disabled	440
	3.3.14	PID 1 / Pid1 integrator preset value PIN 441	+/-300.00%	0.00%	441
	3.3.15	PID 1 / Pid1 reset enable PIN 442	0 - 1	Disabled	442
	3.3.16	PID 1 / Pid1 positive clamp level PIN 443	0 - 105.00%	100.00%	443
	3.3.17	PID 1 / Pid1 negative clamp level PIN 444	0 - -105.00%	-100.00%	444
	3.3.18	PID 1 / Pid1 output % trim PIN 445	+/-3.0000	0.2000	445
	3.3.19	PID 1 / Pid1 Profile mode select PIN 446	1 of 5 modes	0 (constant)	446
	3.3.20	PID 1 / Pid1 Minimum proportional gain % PIN 447	0 - 100.00%	20.00%	447
	3.3.21	PID 1 / Pid1 Profile X axis minimum PIN 448	0 - 100.00%	0.00%	448
	3.3.23	PID 1 / Pid1 Profiled proportional gain output PIN 449	0 - 100.0	0.0	449
	3.3.24	PID 1 / Pid1 clamp flag monitor PIN 450	0 - 1	Low	450
	3.3.25	PID 1 / Pid1 error value monitor PIN 451	+/-105.00%	0.00%	451
	3.3.2	PID 2 / Pid2 output value monitor PIN 452	+/-300.00%	0.00%	452
	3.3.3	PID 2 / Pid2 IP1 value PIN 453	+/-300.00%	0.00%	453
	3.3.4	PID 2 / Pid2 IP1 ratio PIN 454	+/-3.0000	1.0000	454
	3.3.5	PID 2 / Pid2 IP1 divider PIN 455	+/-3.0000	1.0000	455
	3.3.6	PID 2 / Pid2 IP2 value PIN 456	+/-300.00%	0.00%	456
	3.3.7	PID 2 / Pid2 IP2 ratio PIN 457	+/-3.0000	1.0000	457
	3.3.8	PID 2 / Pid2 IP2 divider PIN 458	+/-3.0000	1.0000	458
	3.3.9	PID 2 / Pid2 proportional gain PIN 459	0.0 - 100.00	1.0	459
	3.3.10	PID 2 / Pid2 integrator time constant PIN 460	.01-100.00 s	5.00 secs	460
	3.3.11	PID 2 / Pid2 derivative time constant PIN 461	0 - 10.000s	0.000 secs	461
	3.3.12	PID 2 / Pid2 derivative filter time constant PIN 462	0 - 10.000s	0.100 secs	462
	3.3.13	PID 2 / Pid2 integrator preset enable PIN 463	0 - 1	Disabled	463
	3.3.14	PID 2 / Pid2 integrator preset value PIN 464	+/-300.00%	0.00%	464
	3.3.15	PID 2 / Pid2 reset enable PIN 465	0 - 1	Disabled	465
	3.3.16	PID 2 / Pid2 positive clamp level PIN 466	0 - 105.00%	100.00%	466
	3.3.17	PID 2 / Pid2 negative clamp level PIN 467	0 - -105.00%	-100.00%	467
	3.3.18	PID 2 / Pid2 output % trim PIN 468	+/-3.0000	0.2000	468
	3.3.19	PID 2 / Pid2 Profile mode select PIN 469	1 of 5 modes	0 (constant)	469
	3.3.20	PID 2 / Pid2 Minimum proportional gain % PIN 470	0 - 100.00%	20.00%	470

Property	Paragraph PLA man	Menu / Description	Range	Default	PIN
	3.3.21	PID 2 / Pid2 Profile X axis minimum PIN 471	0 - 100.00%	0.00%	471
	3.3.23	PID 2 / Pid2 Profiled proportional gain output PIN 472	0 - 100.0	0.0	472
	3.3.24	PID 2 / Pid2 clamp flag monitor PIN 473	0 - 1	Low	473
	3.3.25	PID 2 / Pid2 error value monitor PIN 474	+/-105.00%	0.00%	474
	3.4.2	PARAMETER PROFILER / Profile Y output monitor PIN 475	+/-300.00%	0.00%	475
	3.4.3	PARAMETER PROFILER / Profiler mode PIN 476	1 of 5 modes	0 (constant)	476
	3.4.4	PARAMETER PROFILER / Profile Y at Xmin PIN 477	+/-300.00%	0.00%	477
	3.4.5	PARAMETER PROFILER / Profile Y at Xmax PIN 478	+/-300.00%	100.00%	478
	3.4.6	PARAMETER PROFILER / Profile X axis minimum PIN 479	+/-300.00%	0.00%	479
	3.4.7	PARAMETER PROFILER / Profile X axis maximum PIN 480	+/-300.00%	100.00%	480
	3.4.8	PARAMETER PROFILER / Profile X axis rectify PIN 481	0 - 1	Enabled	481
					482
	3.5.2	REEL DIAMETER CALC / Diameter output monitor PIN 483	0 - 100.00%	0.00%	483
	3.5.3	REEL DIAMETER CALC / Web speed input PIN 484	+/-105.00%	0.00%	484
	3.5.4	REEL DIAMETER CALC / Reel speed input PIN 485	+/-105.00%	0.00%	485
	3.5.5	REEL DIAMETER CALC / Minimum diameter input PIN 486	0 - 100.00%	10.00%	486
	3.5.6	REEL DIAMETER CALC / Diameter calculation min speed PIN 487	+/-105.00%	5.00%	487
	3.5.7	REEL DIAMETER CALC / Diameter hold enable PIN 488	0 - 1	Disabled	488
	3.5.8	REEL DIAMETER CALC / Diameter filter time constant PIN 489	0.1 - 200.0 s	5.00 secs	489
	3.5.9	REEL DIAMETER CALC / Diameter preset enable PIN 490	0 - 1	Disabled	490
	3.5.10	REEL DIAMETER CALC / Diameter preset value PIN 491	0 - 100.00%	10.00%	491
	3.5.11	REEL DIAMETER CALC / Diameter web break threshold PIN 492	0 - 100.00%	7.50%	492
	3.5.12	REEL DIAMETER CALC / Diameter memory boot up PIN 493	0 - 1	Disabled	493
	3.6.2	TAPER TENSION CALC / Total tension output monitor PIN 494	+/-100.00%	0.00%	494
	3.6.3	TAPER TENSION CALC / Tension reference PIN 495	0 - 100.00%	0.00%	495
	3.6.4	TAPER TENSION CALC / Taper strength input PIN 496	+/-100.00%	0.00%	496
	3.6.5	TAPER TENSION CALC / Hyperbolic taper enable PIN 497	0 - 1	Disabled	497
	3.6.6	TAPER TENSION CALC / Tension trim input PIN 498	+/-100.00%	0.00%	498
	3.6.7	TAPER TENSION CALC / Tapered tension monitor PIN 499	+/-100.00%	0.00%	499
	3.7.2	TORQUE COMPENSATOR / Torque demand monitor PIN 500	+/-300.00%	0.00%	500
	3.7.3	TORQUE COMPENSATOR / Torque trim input PIN 501	+/-150.00%	0.00%	501
	3.7.4	TORQUE COMPENSATOR / Stiction compensation PIN 502	+/-300.00%	0.00%	502
	3.7.5	TORQUE COMPENSATOR / Stiction web speed threshold PIN 503	0 - 10.00%	5.00%	503
	3.7.6	TORQUE COMPENSATOR / Static friction comp PIN 504	+/-300.00%	0.00%	504
	3.7.7	TORQUE COMPENSATOR / Dynamic friction comp PIN 505	+/-300.00%	0.00%	505
	3.7.8	TORQUE COMPENSATOR / Friction sign PIN 506	0 - 1	Non-invert	506
	3.7.9	TORQUE COMPENSATOR / Fixed mass inertia PIN 507	+/-300.00%	0.00%	507
	3.7.10	TORQUE COMPENSATOR / Variable mass inertia PIN 508	+/-300.00%	0.00%	508
	3.7.11	TORQUE COMPENSATOR / Material width PIN 509	0 - 200.00%	100.00%	509
	3.7.12	TORQUE COMPENSATOR / Accel line speed input PIN 510	+/-105.00%	0.00%	510
	3.7.13	TORQUE COMPENSATOR / Accel scaler PIN 511	+/-100.00	10	511
	3.7.14	TORQUE COMPENSATOR / Accel input/mon PIN 512	0 -105.00%	0.00%	512
	3.7.15	TORQUE COMPENSATOR / Accel filter time constant PIN 513	0 - 200.00 s	0.01 secs	513
	3.7.16	TORQUE COMPENSATOR / Tension demand IP PIN 514	+/-100.00%	0.00%	514
	3.7.17	TORQUE COMPENSATOR / Tension scaler PIN 515	+/-3.0000	1.0000	515
	3.7.18	TORQUE COMPENSATOR / Torque memory select enable PIN 516	0 - 1	Disabled	516
	3.7.19	TORQUE COMPENSATOR / Torque memory input PIN 517	+/-300.00%	0.00%	517
	3.7.20	TORQUE COMPENSATOR / Tension enable PIN 518	0 - 1	Enabled	518
	3.7.21	TORQUE COMPENSATOR / Overwind/underwind PIN 519	0 - 1	Enabled	519
	3.7.22	TORQUE COMPENSATOR / Inertia comp monitor PIN 520	+/-300.00%	0.00%	520
					521
					522
	3.9.2	PRESET SPEED / Preset speed output monitor PIN 523	+/-300.00%	0.00%	523
	3.9.3	PRESET SPEED / Digital input 1 LSB PIN 524	0 - 1	Low	524
	3.9.3	PRESET SPEED / Digital input 2 PIN 525	0 - 1	Low	525
	3.9.3	PRESET SPEED / Digital input 3 MSB PIN 526	0 - 1	Low	526
	3.9.4	PRESET SPEED / Value for 000 PIN 527	+/-300.00%	0.00%	527
	3.9.4	PRESET SPEED / Value for 001 PIN 528	+/-300.00%	0.00%	528
	3.9.4	PRESET SPEED / Value for 010 PIN 529	+/-300.00%	0.00%	529
	3.9.4	PRESET SPEED / Value for 011 PIN 530	+/-300.00%	0.00%	530
	3.9.4	PRESET SPEED / Value for 100 PIN 531	+/-300.00%	0.00%	531
	3.9.4	PRESET SPEED / Value for 101 PIN 532	+/-300.00%	0.00%	532
	3.9.4	PRESET SPEED / Value for 110 PIN 533	+/-300.00%	0.00%	533
	3.9.4	PRESET SPEED / Value for 111 PIN 534	+/-300.00%	0.00%	534
					535

Property	Paragraph PLA man	Menu / Description	Range	Default	PIN
					536
					537
					538
					539
					540
					541
					542
					543
	3.10.2	MULTI-FUNCTION 1 Function mode 1 PIN 544	0 - 6 (1 of 7)	C/O switch	544
	3.10.3	MULTI-FUNCTION 1 Output select 1 PIN 545	0 - 1	Disabled	545
	3.10.2	MULTI-FUNCTION 2 Function mode 2 PIN 546	0 - 6 (1 of 7)	C/O switch	546
	3.10.3	MULTI-FUNCTION 2 Output select 2 PIN 547	0 - 1	Disabled	547
	3.10.2	MULTI-FUNCTION 3 Function mode 3 PIN 548	0 - 6 (1 of 7)	C/O switch	548
	3.10.3	MULTI-FUNCTION 3 Output select 3 PIN 549	0 - 1	Disabled	549
	3.10.2	MULTI-FUNCTION 4 Function mode 4 PIN 550	0 - 6 (1 of 7)	C/O switch	550
	3.10.3	MULTI-FUNCTION 4 Output select 4 PIN 551	0 - 1	Disabled	551
	3.10.2	MULTI-FUNCTION 5 Function mode 5 PIN 552	0 - 6 (1 of 7)	C/O switch	552
	3.10.3	MULTI-FUNCTION 5 Output select 5 PIN 553	0 - 1	Disabled	553
	3.10.2	MULTI-FUNCTION 6 Function mode 6 PIN 554	0 - 6 (1 of 7)	C/O switch	554
	3.10.3	MULTI-FUNCTION 6 Output select 6 PIN 555	0 - 1	Disabled	555
	3.10.2	MULTI-FUNCTION 7 Function mode 7 PIN 556	0 - 6 (1 of 7)	C/O switch	556
	3.10.3	MULTI-FUNCTION 7 Output select 7 PIN 557	0 - 1	Disabled	557
	3.10.2	MULTI-FUNCTION 8 Function mode 8 PIN 558	0 - 6 (1 of 7)	C/O switch	558
	3.10.3	MULTI-FUNCTION 8 Output select 8 PIN 559	0 - 1	Disabled	559
	3.11.2	LATCH / Latch output monitor PIN 561	+/-300.00%	0.00%	560
	3.11.3	LATCH / Latch data input PIN 561	0 - 1	Low	561
	3.11.4	LATCH / Latch clock input PIN 562	0 - 1	Low	562
	3.11.5	LATCH / Latch set input PIN 563	0 - 1	Low	563
	3.11.6	LATCH / Latch reset input PIN 564	0 - 1	Low	564
	3.11.7	LATCH / Latch value for high output PIN 565	+/-300.00%	0.01%	565
	3.11.7	LATCH / Latch value for low output PIN 566	+/-300.00%	0.00%	566
				0	567
	3.12.2	FILTER 1 / Filter1 output monitor PIN 568	+/-315.00%	0.00%	568
	3.12.3	FILTER 1 / Filter1 time constant PIN 569	0 - 32.000 s	1.0 secs	569
					570
					571
					572
	3.12.2	FILTER 2 / Filter2 output monitor PIN 573	+/-315.00%	0.00%	573
	3.12.3	FILTER 2 / Filter2 time constant PIN 574	0 - 32.000 s	1.0 secs	574
					575
					576
					577
	3.13.2	BATCH COUNTER / Counter value monitor PIN 578	0 - 32000	0	578
	3.13.3	BATCH COUNTER / Clock input PIN 579	0 - 1	Low	579
	3.13.4	BATCH COUNTER / Reset enable input PIN 580	0 - 1	Low	580
	3.13.5	BATCH COUNTER / Counter target number PIN 581	0 - 32000	32000	581
	3.13.6	BATCH COUNTER / Count > = than target flag PIN 582	0 - 1	Low	582
	3.14.2	INTERVAL TIMER / Time elapsed monitor PIN 583	0.1 - 600.0 s	0.0 secs	583
	3.14.3	INTERVAL TIMER / Timer reset enable input PIN 584	0 - 1	Disabled	584
	3.14.4	INTERVAL TIMER / Timer interval PIN 585	0.1 - 600.0 s	5.0 secs	585
	3.14.5	INTERVAL TIMER / Timer expired flag PIN 586	0 - 1	Low	586
					587
	3.15.2	COMPARATOR 1 / Input 1 PIN 588	+/-300.00%	0.00%	588
	3.15.3	COMPARATOR 1 / Input 2 PIN 589	+/-300.00%	0.00%	588
	3.15.4	COMPARATOR 1 / Window mode select PIN 590	0 - 1	Disabled	590
	3.15.5	COMPARATOR 1 / Hysteresis PIN 591	0 - 10.00%	0.00%	591
	3.15.2	COMPARATOR 2 / Input 1 PIN 592	+/-300.00%	0.00%	592
	3.15.3	COMPARATOR 2 / Input 2 PIN 593	+/-300.00%	0.00%	593
	3.15.4	COMPARATOR 2 / Window mode select PIN 594	0 - 1	Disabled	594
	3.15.5	COMPARATOR 2 / Hysteresis PIN 595	0 - 10.00%	0.00%	595
	3.15.2	COMPARATOR 3 / Input 1 PIN 596	+/-300.00%	0.00%	596
	3.15.3	COMPARATOR 3 / Input 2 PIN 597	+/-300.00%	0.00%	597
	3.15.4	COMPARATOR 3 / Window mode select PIN 598	0 - 1	Disabled	598
	3.15.5	COMPARATOR 3 / Hysteresis PIN 599	0 - 10.00%	0.00%	599
	3.15.2	COMPARATOR 4 / Input 1 PIN 600	+/-300.00%	0.00%	600

Property	Paragraph PLA man	Menu / Description	Range	Default	PIN
	3.15.3	COMPARATOR 4 / Input 2 PIN 601	+/-300.00%	0.00%	601
	3.15.4	COMPARATOR 4 / Window mode select PIN 602	0 - 1	Disabled	602
	3.15.5	COMPARATOR 4 / Hysteresis PIN 603	0 - 10.00%	0.00%	603
	3.16.2	C/O SWITCH 1 / Control PIN 604	0 - 1	Low	604
	3.16.3	C/O SWITCH 1 / Input HI value PIN 605	+/-300.00%	0.00%	605
	3.16.3	C/O SWITCH 1 / Input LO value PIN 606	+/-300.00%	0.00%	606
	3.16.2	C/O SWITCH 2 / Control PIN 607	0 - 1	Low	607
	3.16.3	C/O SWITCH 2 / Input HI value PIN 608	+/-300.00%	0.00%	608
	3.16.3	C/O SWITCH 2 / Input LO value PIN 609	+/-300.00%	0.00%	609
	3.16.2	C/O SWITCH 3 / Control PIN 610	0 - 1	Low	610
	3.16.3	C/O SWITCH 3 / Input HI value PIN 611	+/-300.00%	0.00%	611
	3.16.3	C/O SWITCH 3 / Input LO value PIN 612	+/-300.00%	0.00%	612
	3.16.2	C/O SWITCH 4 / Control PIN 613	0 - 1	Low	613
	3.16.3	C/O SWITCH 4 / Input HI value PIN 614	+/-300.00%	0.00%	614
	3.16.3	C/O SWITCH 4 / Input LO value PIN 615	+/-300.00%	0.00%	615
PLXm	13.13.2	DRIVE PERSONALITY / Recipe page PIN 678	0 - 4	Normal Reset	677
S/PLXm	13.13.3	DRIVE PERSONALITY / Max current response PIN 678	0 - 1	Disabled	678
PLXm	13.13	DRIVE PERSONALITY / ID ABCXRxxx MON PIN 679	Binary value	By model	679
P/PLXm	13.13.4	DRIVE PERSONALITY / Iarm BURDEN OHMS PIN 680	1 to 327.67R	By model	680

## 4.1.6 Hidden pins 680 - 720

Paragraph PL/X man	Menu / Description	Range	Default	PIN
5.1.2	Power.SAVED ONCE MON PIN 681	0 - 1	low	681
13.7.1.6	DOP1 O/P BIN VAL PIN 682	0 - 1	low	682
13.7.1.6	DOP2 O/P BIN VAL PIN 683	0 - 1	low	683
13.7.1.6	DOP3 O/P BIN VAL PIN 684	0 - 1	low	684
13.6.1.10	DIO1 O/P BIN VAL PIN 685	0 - 1	low	685
13.6.1.10	DIO2 O/P BIN VAL PIN 686	0 - 1	low	686
13.6.1.10	DIO3 O/P BIN VAL PIN 687	0 - 1	low	687
13.6.1.10	DIO4 O/P BIN VAL PIN 688	0 - 1	low	688
6.3	IN JOG FLAG / In Jog mode process flag PIN 689	0 - 1	low	689
PLA manual	WEB BREAK FLAG PIN 690	0 - 1	low	690
12.1.14	SUM1 CH1 SUBTOT / Summer1 Ch1 subtotal monitor PIN 691	+/-200.00%	0.00%	691
12.1.14	SUM1 CH2 SUBTOT / Summer1 Ch2 subtotal monitor PIN 692	+/-200.00%	0.00%	692
12.1.14	SUM2 CH1 SUBTOT / Summer2 Ch1 subtotal monitor PIN 693	+/-200.00%	0.00%	693
12.1.14	SUM2 CH2 SUBTOT / Summer2 Ch2 subtotal monitor PIN 694	+/-200.00%	0.00%	694
PLA manual	WEB SPEED RECT. PIN 695	0 - 105.00%	0.00%	695
PLA manual	REEL SPEED RECT. PIN 696	0 - 105.00%	0.00%	696
PLA manual	UNFILTERED DIAMETER 697	0 - 100.00%	0.00%	697
6.5.1.1	HEALTHY FLAG / Healthy flag output PIN 698	0 - 1	low	698
6.5.1.1	READY FLAG / Ready flag output PIN 699	0 - 1	low	699
8.1.8	STALL WARNING / Stall warning PIN 700	0 - 1	low	700
8.1.11.14	REF XC WARNING / Reference exchange error warning PIN 701	0 - 1	low	701
8.1.11.5	THERMISTOR WARN / Thermistor overtemp warning PIN 702	0 - 1	low	702
8.1.1	SPEED FBK WARN / Speed feedback mismatch warning PIN 703	0 - 1	low	703
8.1.9	I LOOP OFF WARN / Current loop off warning PIN 704	0 - 1	low	704
12.3	LP FILTER INPUT / Low pass filter input PIN 705		From GOTO	705
12.3	LP FILTER OUTPUT / Low pass filter output PIN 706		To GETFROM	706
6.8.9	AUTOTUNE MONITOR / Autotune in progress flag PIN 707	0 - 1	low	707
10.1.4.2	REMOTE PARAM RCV / Remote receive input PIN 708	0 - 1	low	708
6.1.10.3	MOTOR RPM % / Encoder RPM % mon PIN 709,(scaled by 12)MOT/ENC ratio)	+/-300.00%	0	709
12.14.1	POSITION COUNT / Running position counter PIN 710		0	710
12.14.1	POS CNT DIVIDER / Position count divider input PIN 711		1	711
8.1.11.5	USER ALARM INPUT PIN 712	0 - 1	low	712
6.7.1	SPEED LOOP PI OP / Speed loop PI output monitor PIN 700	+/-200.00%	0.00%	713
6.3	IN SLACK FLAG / In Slack mode process flag PIN 714	0 - 1	low	714
7.1.9	SPD FBK % UNF / Unfiltered total speed feedback % mon PIN 715	+/-300.00%	0.00%	715
7.1.7	TACHO % UNF / Unfiltered analog tachometer % mon PIN 716	+/-300.00%	0.00%	716
7.1.8	MOTOR RPM UNF / Unfiltered motor RPM monitor PIN 717	+/-6000	0	717
7.2.1	CUR DEMAND UNF / Unfiltered current demand monitor PIN 718	+/-150.00%	0.00%	718
7.2.2	CUR FBK % UNF / Unfiltered current feedback % monitor PIN 719	+/-150.00%	0.00%	719
6.5.1.1	SYSTEM RESET / System reset pulse output PIN 720	0 - 1	low	720

## 5 Index

Base rated motor rpm .....	69	Rated armature amps .....	69
Batch counter .....	62	Rated armature volts .....	69
Coast stop .....	11	Rated field amps.....	69
Control terminals.....	11, 12, 13	Reel diameter calculator.....	35
Current limit% .....	69	Remote AVF .....	12
Desired max rpm .....	69	Simple logical and linear processing.....	49, 55
General purpose filters 1 and 2.....	60	SOFTWARE TERMINALS .....	73
IR compensation .....	69	Speed feedback type.....	69
Latch block.....	58	Summer 1 and 2.....	18
Motor drive alarms .....	71	Tachogenerator .....	69
Parameter profile .....	31	Taper tension calculator.....	39
PID 1 and 2 .....	23	Warning .....	7, 8, 36, 78
Preset speed block .....	52	Winding torque compensator.....	35, 42

### PIN number tables

The description of every parameter can be located by using the table in chapter 4. They are listed in numeric order under convenient headings. The tables contain a cross reference to each parameter paragraph number.

## 6 Record of PLA manual modifications

Manual Version	Description of change	Reason for change	Paragraph reference	Date	Software version
5.02p	PLA manual.	First public issue of PLA manual		July 2002	5.02
5.11	Improve tach input range for small signals.	Enable use of full scale tacho signals of 10V.	Main manual. 6.1.8	Oct 2002	5.11
5.12	See main manual for general functional changes. Note. The default % DIAGNOSTIC summary windows are not enabled on the PLA	These windows not relevant to PLA function.	Main manual 5.16	Jan 03	5.12

## 7 Record of PLA blocks bug fixes

Manual Version	Description of change	Reason for change	Paragraph reference	Date	Software version
5.02p	PLA manual.	First public issue of PLA manual		July 2002	5.02
5.11	No bugs recorded.			Oct 2002	5.11
5.12	No bugs recorded.			Jan 2003	5.12

Please refer also to the PL/X product manual for other bug fixes.

## 8 Changes to product since manual publication

Any new features that affect the existing functioning of the PLA, that has occurred since the publication of the manual, will be recorded here using an attached page.

