

TURNVISION™

Vision Readout Systems for Mills



REFERENCE
MANUAL

ACU-RITE®

INSTALLATION

The Modular Concept	4
Installing/Removing Modules	4
TURNVISION Keypad	6
Bench Testing	8
Installation/Mounting	10
Modes of Operation	12
The HELP Mode	13
The Sleep Screen	16
The SET SYS Mode	16
Password Protection	16
TURNVISION Default Values	18
Assigning Axis Labels	18
Setting Encoder Parameters	20
Finding the Home Reference Point (FTO)	23
TURNVISION vs Machine Geometry Error	25
Selecting Single and Multiple	
Interval Error Compensation	28
Setting Up Single Interval Error Compensation	30
Setting Up Multiple Interval Error Compensation	31
Editing Both Single and Multiple	
Interval Compensation Values	36

STANDARD MACHINING PROCEDURES

The DRO Mode	40
Near Zero Display Indicator	43
Multiple Scale Coupling (MSC)	44
Display Multipliers	46
Vectoring	47
Presetting/Machining to Zero	48
Absolute Presetting	48
Incremental Presetting	48
Reference Presetting	49
Zero Resetting	49
The FREEZE Feature	50
Set Tool Mode	51
Tool Offsets	51
Auto Tool Offsets	52
Tool Adjust	54
The Calculator Mode	55
Taper Calculator	55
RPM Calculator	57
Resetting TURNVISION Memory	58

PROGRAM OPERATION

The Program Mode	60
Program Step Information	60
Z-Axis Coupling	60
Creating/Entering a Program	63
Viewing, Editing, and Deleting a Program	64
Running and Learning Programs	65

TURNVISION™

TURNVISION

Table of contents

OPTIONS

Footswitch Option	OP3
Edge Finder	OP3
Standard Edge Find	OP4
Workpiece Positioning	OP5
Two Point Calculator	OP7
Parallel Communications Output	OP7
External Video Monitor	OP10
RS-232 Communications	OP11
Printer Function	OP14
Program Storage	OP15
Program Transfers	OP15
Computer Communication	OP18
Data Requests	OP19
Remote Keyboard	OP21
Option Appendices	OP23

APPENDICES

Troubleshooting	68
Ventilation System	68
TURNVISION Fuses	68
Software Errors	69
Warranty	70
Specifications	71
Glossary	72
Encoder Specifications	74

TURNVISION™

TURNVISION was designed and built with a modular concept. The modular units consist of the chassis assembly, the video unit, the axis modules and central processing unit (CPU). The axis modules and the CPU module are slide-in boards. The module slots are designed so that only the corresponding module can go into the proper slot.

The modular concept

The video screen (CRT) and chassis assembly are not intended to be maintained in the field. The unit should be returned to the distributor or original equipment manufacturer if there are problems with the screen, on/off switch, contrast, or keypad.

TURNVISION was designed to make board replacement and installation of additional options (boards) possible on the job site (see below). It should be noted, however, that changing modular boards is the only level of maintenance authorized by ACU-RITE. If the problem is not a board-related malfunction, the entire unit must be returned for service.

The standard 2-axis TURNVISION can be upgraded to 4-axis by the addition of an axis module (Part Number 387802-6000) to one of the appropriate expansion slots (Figure 1).

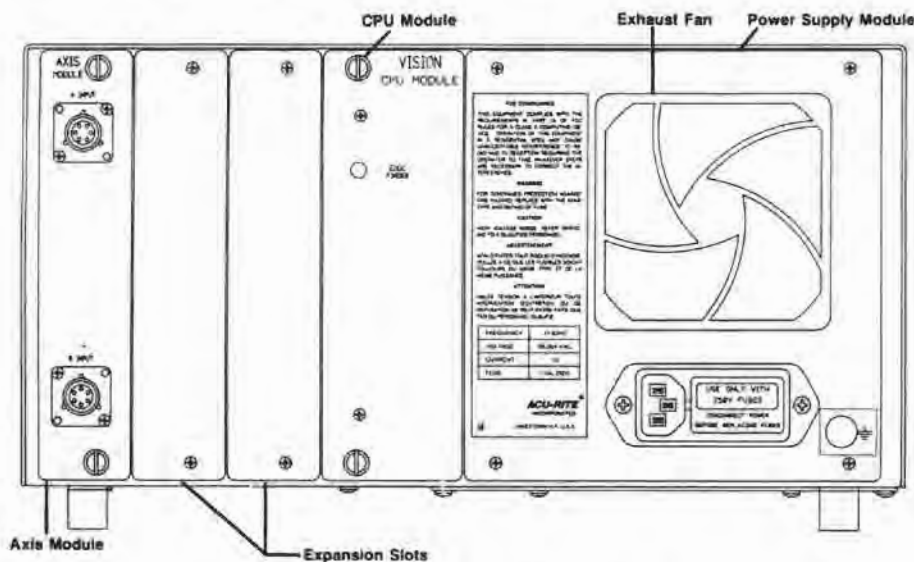

Figure 1. Module Locations.

The standard TURNVISION can be expanded to a "full-option" VRO by adding the option module (Part Number 387800-4060) into an expansion slot. Option capabilities are explained in the tab section "OPTIONS".

Option module

To remove an axis module or a CPU module, proceed as follows:

- 1) Turn TURNVISION off, and unplug the unit.
- 2) Remove the two screws and cover plate from the desired module slot on the back of TURNVISION (Figure 2).

Installing/removing TURNVISION modules

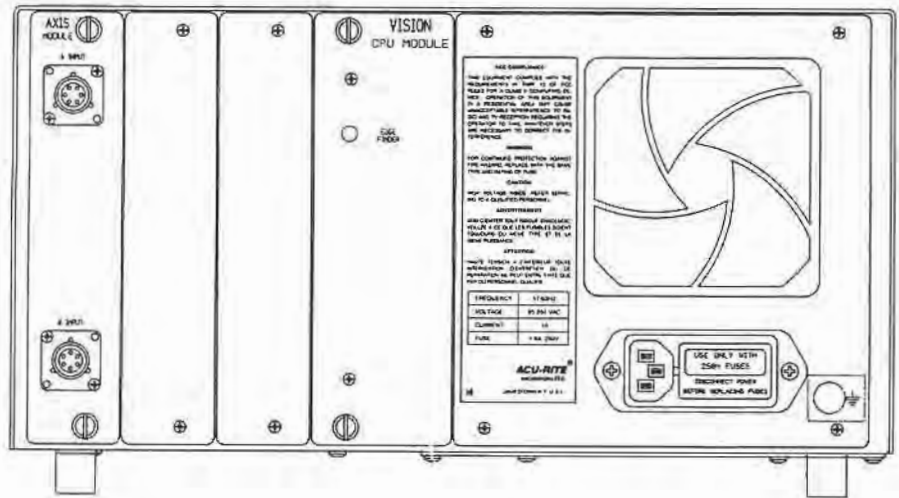

Figure 2. Rear Panel.

3) Gently pull the module out, sliding it along the tracks.

To install a new module, proceed as follows:

1) Slide new module into chassis until rear plate is tight to chassis frame (Figure 3).

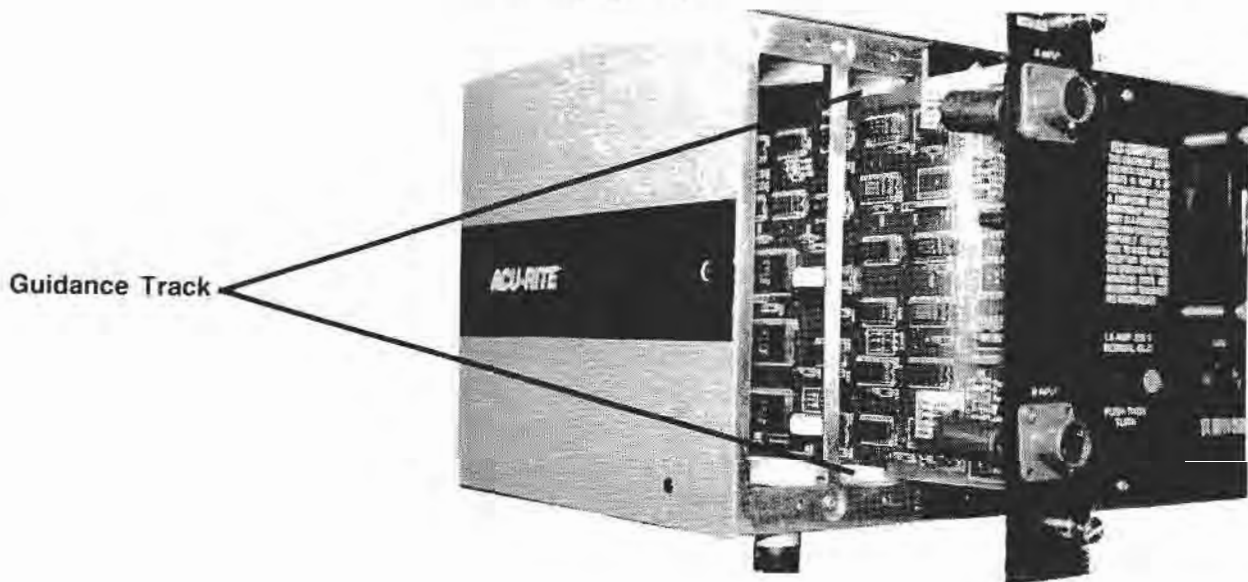

Figure 3. Module Installation.

Some resistance will be felt when pushing the module in the last half inch; the connector on the module is making contact with the connector in the chassis. **Do not force the module in place.**

5) Once the module is in all the way, tighten the retaining screws finger tight.

TURNVISION is now ready to go back to work.

TURNVISION has 46 tactile keys used to input and manipulate data, a power switch and a contrast adjustment knob. A slight "click" is heard and felt when pressing the tactile keys. The ON/OFF rocker switch powers the unit and the adjustment knob controls the contrast of the screen.

TURNVISION keypad

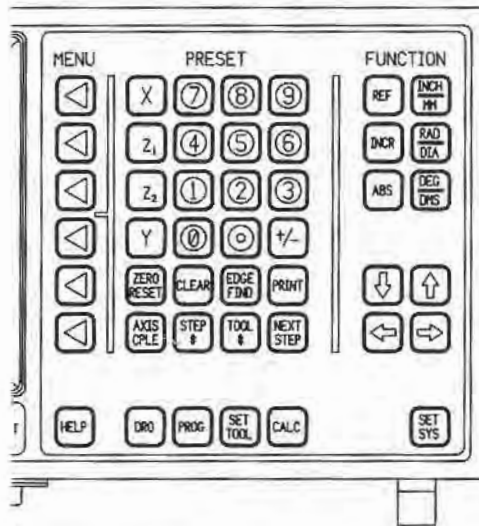







Figure 4. TURNVISION Keypad.

The 46 keys are grouped in five major sections:

MENU keys - There are six menu keys located on the far left of the keypad. The menu keys correspond to an instruction or function enclosed in a box, on the screen. The instruction or function box is activated when the menu key to the right is pressed. If a menu key with no corresponding screen information is pressed, an "Incorrect Keypress" message will be displayed on the screen.

PRESET keys - The PRESET keys consist of the following sub-groups:

-  **Numeric** keys - keys 0 through 9, the decimal point key, and the +/- sign key, are used to enter numeric values.
-  **Axis** keys - X, Z1, Z2, and Y keys are used to select an axis or axes during TURNVISION functions.
-  **ZERO RESET** key - used to reset an axis (or axes) display.
-  **CLEAR** key - used to erase previous data, so new values can be entered.
-  **EDGE FIND** key - activates the edge find function on units equipped with the option module.

 **PRINT** key - activates an optional connected printer to print the current screen information when unit is equipped with the option module.

 **AXIS CPLE** key - (short for Axis Coupling) the capability of mathematically combining (adding, subtracting or averaging) the signals from two parallel linear encoders to display one resultant motion.

 **STEP # and NEXT STEP** keys - used while running or learning a program to move to another step in the program.

 **TOOL #** key - used to indicate a tool to be used for an operation. If tool offsets are assigned to the tool number, TURNVISION adjusts the axes' displays in the DRO and program modes.



FUNCTION keys - six keys located in the upper-right of the keypad. Three of the keys, REF, INCR, and ABS, are used to preset an axis. The INCH/MM, RAD/DIA, and DEG/DMS keys are display format functions and are detailed below.

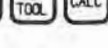
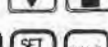

CURSOR MOVEMENT (ARROW) keys - located in lower-right of the keypad, these keys move the cursor or highlighted areas on the screen in the direction the arrows point.

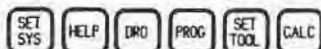

MODE keys - located across the bottom of the keypad, these six keys access a mode of operation.

Special function keys

The INCH/MM key

Axis positions, both incremental and absolute, may be displayed in either inches or millimeters for linear encoders. The desired units of measurement (English or Metric) may be selected by pressing the INCH/MM key which toggles between the two measurements. Conversions from inch to metric are performed immediately. Current units are indicated in the status area of the DRO display.



The RAD/DIA key

Linear axis measurements can be displayed as a radius or a diameter value. When setting axis parameters (page 20), axes must be defined as being a "crossfeed" or a "longitudinal" axis type. The "crossfeed" axes will display a "RAD" or "DIA" marker in the status area below the axis display to indicate the displayed measurement unit. The "longitudinal" axes remain unaffected.



The DEG/DMS key

This key represents decimal degrees (DEG) and degrees-minutes-seconds (DMS) and is used to toggle, at any time, between the two formats for angular encoders. Angular axis position is displayed in the same format as linear axes position. Angular axis displays have a degree symbol following both the incremental and absolute displays.

TURNVISION™

Bench testing

Prior to installation, the following simple bench test should be run:

1. Connect TURNVISION to power. TURNVISION has the following power requirements:

Voltage - 95 to 130 VAC or 180 to 250 VAC, 47 to 63 Hz

Amperage - 1.5 Amp

TURNVISION has a two-position voltage selector switch on the back panel. The 115V position is used for incoming voltages between 95 to 130 VAC. The 230V position is used for incoming voltages between 180 to 250 VAC. To change the voltage selector, turn the unit off, then use a screwdriver to gently slide the switch up or down until the correct voltage position is visible.

2. Turn the power switch ON. "TURNVISION by ACU-RITE" should appear on the opening screen. This screen also indicates the software version currently installed in memory.
3. Press any key to continue (except HELP).
4. Disregard any messages on the screen and press the  mode key (bottom right on keypad).

If the DRO mode key was selected and pressed to perform the "continue" routine referenced in step 3, and a "Check Filter Press Help" message is displayed, press the HELP mode key. Filter, ventilation fault checks and remedial recommendations will appear on the screen. Rectify the problem and continue the bench test by pressing the "RESUME" menu key followed by the SET SYS mode key.

For further information please refer to the Troubleshooting "Ventilation system" section in the APPENDICES tab section, page 68).

5. Press the "MISCELLANEOUS" menu key.
6. Press the "TESTS" menu key.
7. Press the "KEYBOARD TEST" menu key.

To check a key, simply press that key. Its location on the screen (simulated keypad) should become highlighted. When all keys have been checked, hold down one key for a few seconds to return to the MISCELLANEOUS MENU (Figure 5).

Bench testing (cont.)

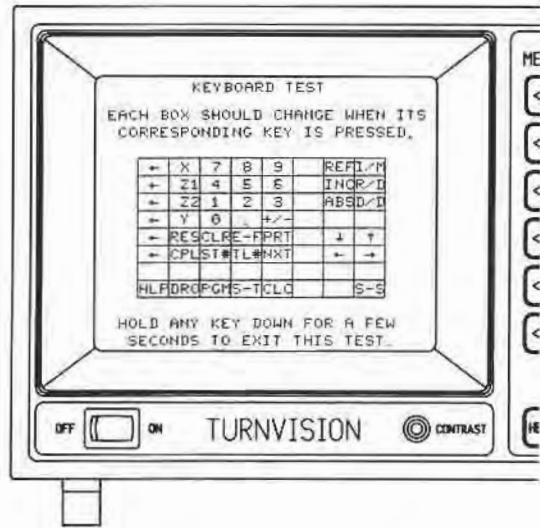

Figure 5. Keyboard Test.

8. Press the "VIDEO TEST" menu key.

The video test displays a grid pattern on the screen. The grid lines should be straight, both vertically and horizontally. Arrows along the right hand side of the screen should line up with the center of the menu keys. Press any key to end the video test.

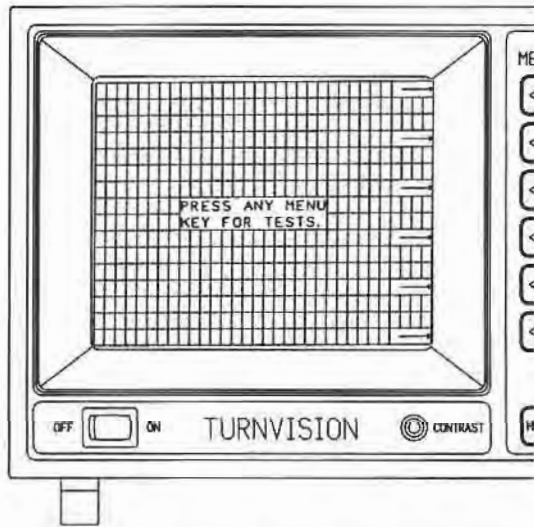

Figure 6. Video Test.

TURNVISION™

9. Press the "MEMORY TEST" menu key.

The memory test will check both the Random Access Memory (RAM) and the Read Only Memory (ROM). If a bad memory location is detected in RAM, the location will be indicated. A Checksum Technique is used to check the ROM memory. A number will appear on the screen when the test is complete. If a memory problem is indicated, contact your ACU-RITE distributor or OEM.

Press the "TESTS MENU" key to return to the TESTS menu screen.

10. When all tests have been conducted, turn the unit off.

If any of the above steps cannot be completed or if any of the screens differ from the above descriptions, contact your ACU-RITE distributor or OEM for further instructions.

Location is an important consideration for proper installation. The following points should be kept in mind when selecting a safe and convenient location:

1. Ease of operator reach.
2. Approximate eye level to the operator.
3. Avoid moving components or tools, and coolant splash.
4. Operating environment must be 5° to 40° C (41° to 104° F), with a non-condensing relative humidity of 25-95%.
5. TURNVISION's CRT, like all CRTs, can be adversely affected by a strong magnetic field. Therefore, it should be mounted away from any source of magnetism and magnetic base holders should never be set on top of TURNVISION.
6. To avoid overheating, TURNVISION should have adequate airflow around and under the unit. Access to the filter assembly is also needed for periodic maintenance (for further information refer to "Troubleshooting", (page 68).

ACU-RITE has developed specific mounting kits for TURNVISION which are applicable to most common mounting configurations. The kits are available from your ACU-RITE distributor and come complete with hardware and mounting instructions.

Careful consideration should be given when fabricating a support device for TURNVISION. It should be large and strong enough to accommodate the readout and any other devices that may be placed on top (printer, etc).

Installation location considerations

Proper mounting

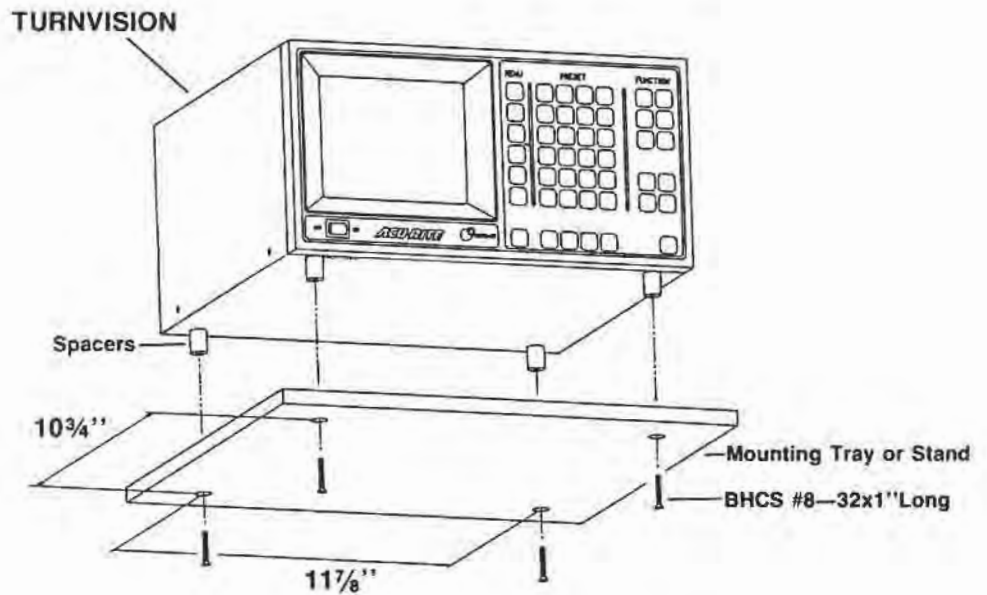

Figure 7. Mounting on Tray or Stand.

Connecting linear encoders

After axis encoders (scales) have been installed, the input connectors are plugged into the back of TURNVISION. Insert the male connector with the large spline up, into a mating receptacle and lock in place with a 1/4 turn.

Make sure there is enough slack in the encoder cables to allow for full travel of each machine axis.

Connector specifications are given on page 74, in the APPENDICES tab section. The encoder input receptacles are labeled "A INPUT" and "B INPUT". It is not important which axis is plugged into which receptacle because each input is assigned an axis label (X, Z1, Z2, or Y) while setting encoder parameters (see page 20).

TURNVISION™

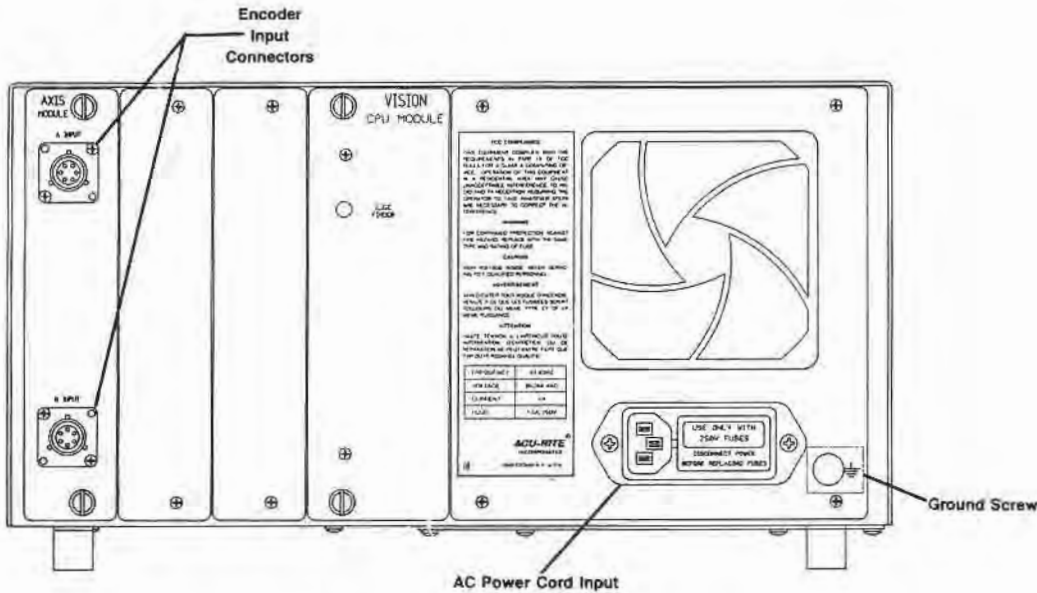

Figure 8. Power and Encoder Connections.

TURNVISION has seven operational modes. The first mode is the Power-Up mode, automatically entered when TURNVISION is turned on or when there has been a power interruption. The other six modes are selected from the keyboard using the tactile mode keys along the bottom of TURNVISION's keypad. The six user modes are as follows:

Modes of operation

Set System Mode - used to set parameters for the incoming encoder information and to display it to the operator. The encoder parameters should be entered into the unit during the installation of the system as explained on page 20.

Programming Mode - the operator can create programs for machining repetitive parts. This mode has routines to create, view, edit, run and learn programs.

Set Tool Mode - used to enter and store tool offset dimensions. TURNVISION can retain information for up to 24 tools with offsets in two axes.

DRO Mode - the "workhorse" mode within TURNVISION. Standard machining (without a program) is done in the DRO mode.

Calculator Mode - gives access to a four-function calculator, taper calculator, and RPM calculator. The standard calculator also allows the operator to do calculations using information directly from the preset register, and add or replace the calculation result back into the preset register.

NOTE: Axis positions are maintained while every mode is active; positional information is never lost while the readout is on.

Help Mode - an "operator's manual" that is only an arm's reach away. The Help mode key accesses screens covering all topics of concern to the operation of TURNVISION. It is accessible from any mode and will offer help relating to the screen the operator is viewing when entering the help mode. After reading the information provided, in most modes, the operator can ask for "More Help", or return to the screen displayed prior to pressing the HELP key. A complete outline of all help screens available can be found on pages 14-15.

The HELP mode

Pressing the HELP Key once will access help for the current operation. To access the GENERAL HELP INDEX press the HELP key twice.

Each section in the GENERAL HELP INDEX has its own index. When moving through various HELP screens, press the top menu key to get back to the index for that section.

The following is an outline which illustrates the software structure sequences in the HELP Mode. Many help screens offer "More Help" (additional information screens). Each "More Help" screen is identified with a sequential number ([1], [2], etc.) in the upper left of the screen.

GENERAL HELP INDEX

1. HOW HELP WORKS
2. SET SYS HELP
3. OTHER MODES
4. TABLES
5. RESUME

1. HOW HELP WORKS

2. SET SYS HELP

- SETTING AXIS INFORMATION
 - LABELING THE AXES
 - SETTING THE AXIS PARAMETERS
 - USING ERROR COMPENSATION
 - USING VECTORING
- SETTING REFERENCE POINTS
- SETTING DRO DISPLAYS
- MISCELLANEOUS
 - RESETTING ALL MEMORY TESTS
 - KEYBOARD TEST
 - VIDEO TEST
 - MEMORY TEST
 - HARDWARE IDENTIFICATION
 - JUMPING TO WHERE SET SYS WAS LEFT
 - OPTION CONFIGURATION
 - PARALLEL PRINTER PORT
 - RS-232 PORTS
 - RS-232 FUNCTIONS
 - RS-232 PROTOCOLS
 - FOOTSWITCH

3. OTHER MODES

- DRO HELP
 - ZERO RESET & PRESETTING
 - SPECIAL KEYS
 - AXIS CPLE
 - TOOL #
 - INCH/MM, RAD/DIA, DEG/DMS
 - EDGE FINDER
 - MISCELLANEOUS
 - FILTER MAINTENANCE
 - ERROR RECOVERY
- PROG HELP
 - ABOUT THE PROGRAM DIRECTORY
 - DELETING A PROGRAM
 - CREATING A PROGRAM
 - WORKING WITH PROGRAMS
 - RUNNING OR LEARNING A PROGRAM
 - EDITING A PROGRAM
 - VIEWING A PROGRAM
 - PROGRAM OPTIONS
 - PRINTING A PROGRAM
 - PROGRAM TRANSFERS

SET TOOL HELP
EDGE FINDER OFFSETS
EDIT EDGE FINDER OFFSETS
AUTO EDGE FINDER OFFSETS
EDIT TOOL OFFSETS
AUTO TOOL OFFSETS
CALC HELP
ACTIVE KEYS
NUMBER KEYS
CLEAR KEY
MENU KEYS
CALC KEY
HOW TO USE THE CALCULATOR
HOW TO CALCULATE TAPER
HOW TO CALCULATE RPM
SURFACE SPEED TABLE

4. TABLES

THREAD INFORMATION (INCH)
THREAD INFORMATION (MM)
SURFACE SPEEDS

5. RESUME

Returns the screen back to the previous mode or function.
To exit the HELP Mode, press the "RESUME" menu key.

Another unique feature of TURNVISION, is the "sleep screen". This feature extends the life of the CRT by blanking the screen and flashing a "SLEEPING" message, during long periods of nonuse. After approximately 10 minutes without any activity on the keyboard or information coming from the encoders, TURNVISION will go into its "sleep" mode. As soon as any key is pressed, the screen will return to the previous display. The only screens that don't "sleep" are the HELP screens and the welcome, power-up screen.

The sleep screen

TURNVISION must know several pieces of important information before it can supply correct position readout to the operator. These pieces of information, or parameters, includes axis and encoder labels, resolution, etc. To set parameters, a password must first be entered (see below).

The SET SYS mode

A password is required to change axis parameters and to reset memory. Password protection is a safeguard against accidentally changing axis parameters (axis labels, error compensation, etc.). The following page contains the password for this TURNVISION. If desired, the page can be removed.

Password protection

PASSWORD 8891

TURNVISION™

Password: **8891**

TURNVISION™

TURNVISION comes from the factory with default states for the axis and encoder parameters. If encoder requirements match the default states, it is not necessary to change any of the axis or encoder parameters.

TURNVISION default states

AXIS LABELS	1A - X 1B - Z1 2A - Z2 2B - Y
AXIS MOTION	LINEAR, ALL AXES
AXIS RESOLUTION	10 MICRON, ALL AXES
FTOs AVAILABLE	NO, ALL AXES
COUNT DIRECTION	POSITIVE, ALL AXES
AXIS TYPE	LONGITUDINAL - Z1, Z2, Y AXES; CROSSFEED - X AXIS
ERROR COMPENSATION	0 PPM, ALL AXES
ROUND-OFF VALUES DRO MODES 1 AND 2	.01mm (.0005") ALL AXES
NEAR-ZERO VALUES DRO MODES 1 AND 2	0
MULTIPLIER	+ 1, ALL AXES

Figure 9. Default Table.

Individual axis encoders are randomly plugged into any of the available connectors on the back of TURNVISION (axis modules). Axis labels are then assigned as follows:

Assigning axis labels

- 1) Press  mode key.
- 2) Press "SET AXES" menu key.
- 3) Enter password. "8891"
- 4) Press "LABEL AXES" menu key.

The AXIS LABELS screen (Figure 11) represents the input ports, 1A through 3D, on the back of TURNVISION.

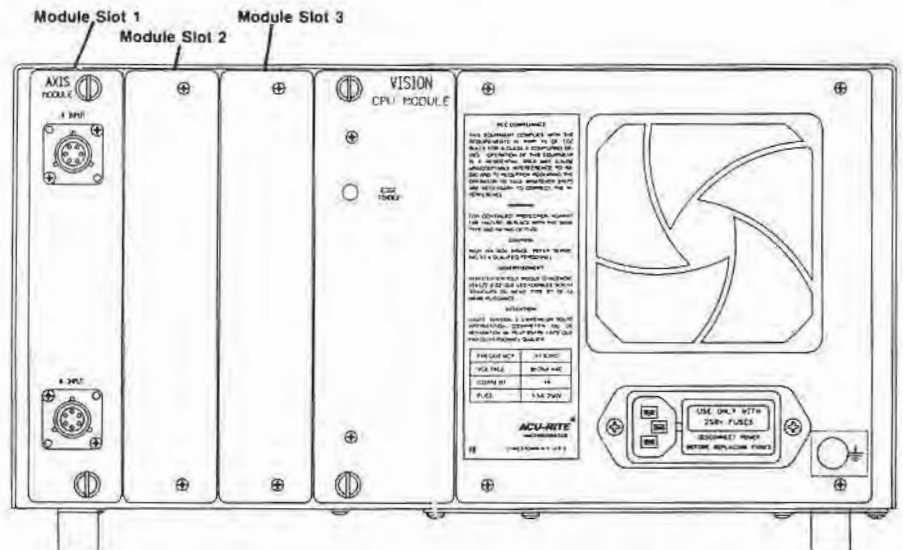

Figure 10. Axis Module Locations.

- 5) Highlight an input axis by using the arrow keys. Axes marked "N/A" are not available with current hardware, but can be upgraded with additional axis modules.
- 6) Clear current label using the key or leave the default axis label.
- 7) Assign the desired axis label by pressing X, Z1, Z2, or Y axis key. **If the desired axis label is already displayed on another axis, it must first be cleared from its present assignment.**

Repeat the above process for each input slot that has an encoder connected to it. When all axis labels have been assigned, return to the AXIS INFORMATION Menu by pressing the "FINISHED" menu key.

NOTE: If axis labels need to be changed to other than default values, it may be necessary to refer to page 43 to ensure new labeled axis will be displayed in the DRO Mode. Default displays are X, Z1 for single axis module units, and X, Z1, Z2, Y for double axis module units.

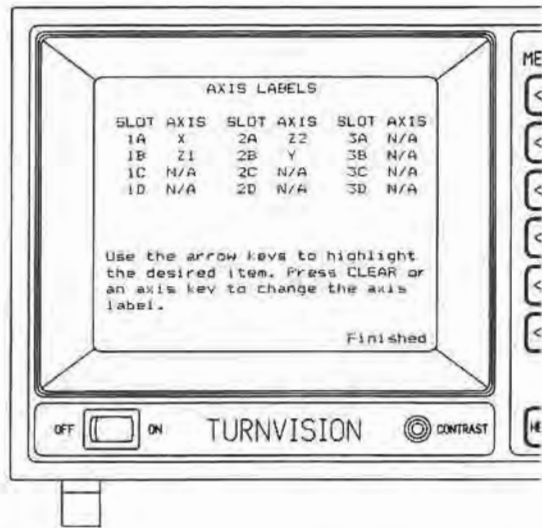

Figure 11. Axis Labels Screen.

After axis labels have been assigned to each input slot, it is necessary to program specific facts about the individual encoders associated with each axis label. Enter encoder parameters as follows:

- 1) Press the "SET PARAMETERS" menu key (AXIS INFORMATION screen).

The SET PARAMETERS menu screen shows an axis and five facts concerning that axis. These parameters are listed in a format with the current value or status shown for each parameter.

- 2) To change a parameter, highlight the parameter by using the arrow keys. As each parameter is highlighted, available choices (menu keys) are displayed.
- 3) To select a new value or status, press the corresponding menu key. The new parameter value will then be displayed.

"Motion type" refers to the type of motion the encoder is measuring. Two types are available — linear and angular.

"Resolution" is the size of the increment of position that the encoder indicates. Standard linear encoder resolutions are as follows:

1000 μm	50 μm	2 μm	.1 μm
500 μm	20 μm	1 μm	.05 μm
200 μm	10 μm	.5 μm	.02 μm
100 μm	5 μm	.2 μm	.01 μm

To select one of these values, use the menu keys "Finer" and "Coarser" until the correct value is shown for "Res. (microns)". To accommodate English-ruled linear encoders and linear encoders with resolutions not listed, direct keyboard entry can be used to define the resolution.

Setting encoder parameters

Parameter descriptions

TURNVISION™

Clear the current resolution by using the CLEAR key and enter the scale resolution in **microns** by using the numeric keys on the keypad.

Note: All entries (English or Metric ruled encoders) must be entered in microns (.001 mm). For example, to enter a .0005" resolution encoder, multiply .0005" by 25,400 microns/inch. This translates to a metric resolution 12.7 microns which is then keyed in as the scale resolution.

When installing 5 μm (.0002") scales on lathe crossfeed applications, the following parameters must be set:

```
"AXIS PARAMETER"  
  "Res. (Microns):    5."  
  "Axis type:        Crossfeed"
```

For half-thousandths "Diameter" display, "ROUND Off Values" ("SET DRO DISPLAYS") must be set at .0002" (see page 43).

Standard resolutions for angular motion in counts per revolution (cnt/rev.) are as follows:

36,000,000	1,800,000	72,000	3,600
18,000,000	720,000	36,000	1,800
7,200,000	360,000	18,000	720
3,600,000	180,000	7,200	360

Note: If keyboard entry is necessary for an angular encoder, it must be entered in *counts per revolution*.

"FTO" refers to a signal pulse generated when a fiducial trigger output (reference) mark on a scale is sensed by the scale reading head. This reference mark can be used to automatically reset the readout display to the last workpiece zero. ACU-RITE linear encoders are available with FTO signals, and are labeled on scale as "ABSOLUTE ZERO" or "ABSOLUTE ZERO II". The FTO parameter is a YES or NO selection.

"Count Direction" refers to assigning a positive or negative value to axis motion. This assignment is the preference of the operator or shop. Some shops feel that if the carriage movement towards the tail stock is a positive movement, while other shops refer to this as a negative movement.

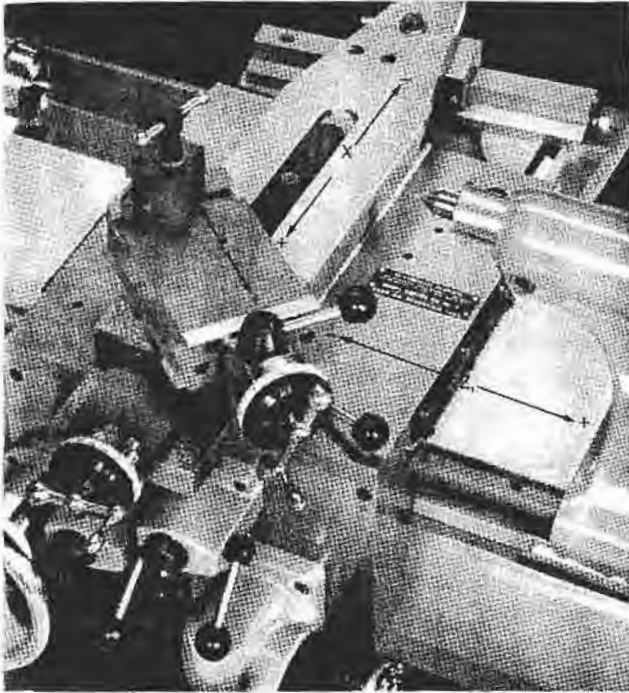

Figure 12. Axes Count Directions.

To set the count direction:

- 1) Press mode key.
- 2) Move the axis in question, observing the motion polarity (display becoming more negative indicates a *negative* count direction, display becoming more positive indicates a *positive* count direction).

If this count direction is in agreement with shop standards, no change for that axis is necessary.

If the count direction is opposite from shop standards, proceed to the following steps:

- 3) Press the mode key.
- 4) Press the "Jump to where SET SYS was left" menu key. This will return the display to the AXIS PARAMETERS screen.
- 5) Make sure the axis being worked on is indicated at the top of the screen; if not, press the correct axis key.
- 6) Use the "down" arrow key to move to the "Count Direction" parameter and then press the *opposite* status.
- 7) Repeat the above procedure to ensure the axis motion is now in agreement with shop standards.

Setting the count direction

TURNVISION™

Finding the home reference point (FTO)

“**Axis type**” refers to the axis as being either a longitudinal or a crossfeed axis. An axis indicated as a crossfeed axis can have its position displayed as a radius or diameter value. The radius/diameter value is part of the axis display (DRO mode) and can be changed instantly by pressing the RAD/DIA key.

With ACU-RITE ABSOLUTE ZERO linear encoders, FTO reference marks can be used to easily locate the workpiece zero. Every time TURNVISION is turned off, or power is interrupted, all axis position information is lost. The readout cannot tell if the encoder has moved while the power is off and when power is restored, TURNVISION resets all axes to 0.0. Therefore, the current positions of the axes, relative to the mounted workpiece, are lost until the axes positions are reset. **It is very important to find the same home reference point every time TURNVISION is powered up.**

To find the home reference point proceed as follows:

- 1) Press the  key.
- 2) Press the “SET REF. POINT” menu key.
- 3) Press the corresponding axis key (X, Z1, Z2, Y) for the axis the home reference point is to be set.

Only axes for which parameters were set indicating they have FTOs are now listed as available for setting home reference points.

- 4) Press the “Ready” menu key.
- 5) Slowly move through an FTO mark on the scale in the positive count direction.

The FTO mark will only be sensed if the axis is moving in a positive count direction. Once the reading head has passed over an FTO mark on the linear encoder, TURNVISION will indicate the home reference point has been found.

Finding the home reference point (cont.)

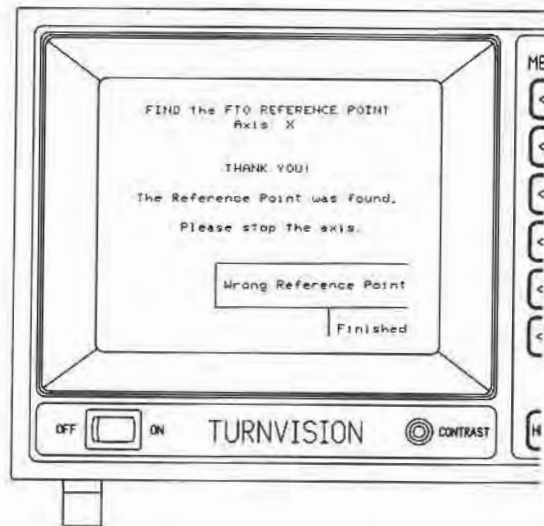

Figure 13. FTO Reference Point Screen

- 6) Press the "Finished" menu key or press the "Wrong Reference Point" menu key to select a different point.
- 7) Once the reference point is acceptable, it is extremely important to draw a line on the scale casing at the approximate location of the reference point (FTO). This will aid in locating the FTO reference point quickly each time there is a need to find the same home reference point. These FTO reference marks and their function **must** be understood by the machine operator.

Repeat the above procedure for each axis requiring a home reference point.

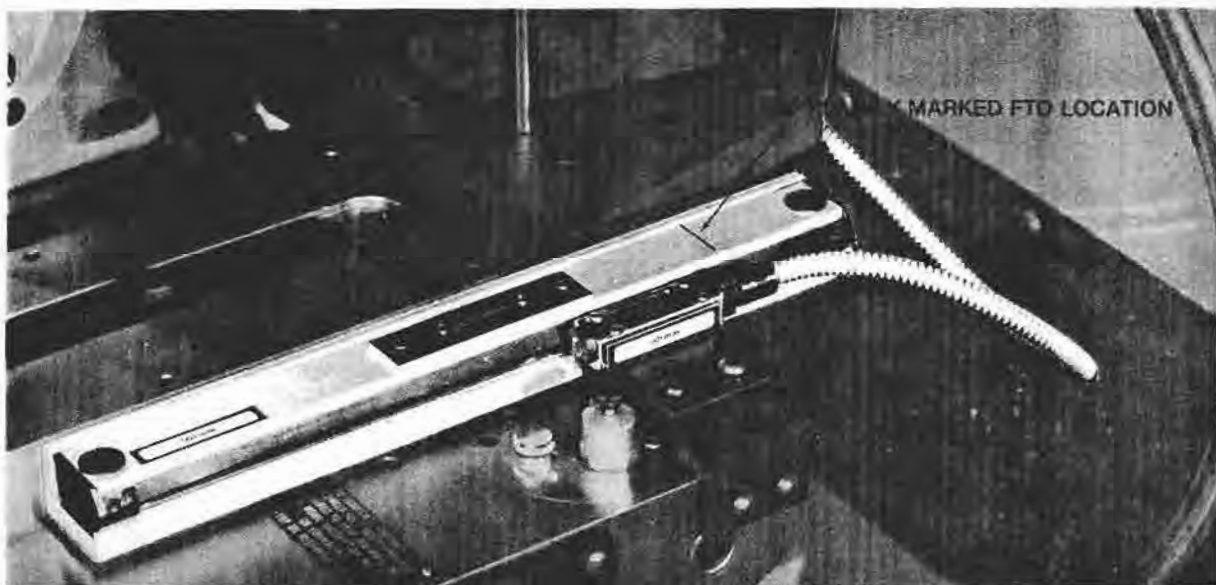

Figure 14. FTO Marker on Linear Encoder.

TURNVISION™

TURNVISION vs machine geometry error

All machine tools, new or old, contain some error in the accuracy of indicated motion when compared to a standard which is known to be true. TURNVISION helps compensate for this form of error.

To properly program for error compensation, please read this entire section.

Machine error is caused by at least one of the following machine tool deficiencies:

- A. The fit between mating surfaces is loose, either because of manufacturing tolerances, subsequent wear, or improper gib adjustment.
- B. The ways are not scraped straight or are not aligned perfectly at assembly.
- C. Driving and cutting forces cause deflections (since no material is completely rigid).
- D. Temperature gradients can distort machine geometry.

Errors caused by C and D (above), must be compensated by using correct machining practices and maintain the machine in a temperature-stable environment.

Machine inaccuracies caused by A and B (above), can be significantly reduced by programming TURNVISION's error compensation. Since machine tool error is a constant, it can be measured and graphed. Error compensation values can then be programmed into TURNVISION. The resulting error compensation values can then be programmed as a single interval compensation or into multiple intervals. The two examples below will show how each, single and multiple error compensation, are determined.

Error Analysis (Example 1)

Error Analysis (Example 1) - Incremental moves were made along the entire length of an axis. For each move, the readout display, with no compensation, was compared with the distance moved by using certified gage blocks or by using a laser interferometer. Both the actual travel and the travel displayed on the readout were recorded. The readout measurements were then subtracted from the actual measurements to represent the error values.

The error values were plotted against the distance traveled. A line was drawn representing the "best-fitting" straight line among the plotted points (the line should pass through the 0, 0 point). From the chart and plot (Figures 15a & 15b), it can be seen that error is increasing at a near constant rate as we move along the axis. This is an example of single interval error compensation.

Distance Measured by Standard	Measurement Displayed on Readout	Difference Between Measurements
0.000	0.000	0
3.0000	3.000	0
6.0000	5.9995	-.0005
9.0000	8.9995	-.0005
12.0000	11.9990	-.0010
15.0000	14.9990	-.0010
18.0000	17.9990	-.0010
21.0000	20.9985	-.0015
24.0000	23.9985	-.0015
27.0000	26.9985	-.0015
30.0000	29.9980	-.0020

Figure 15a. Error Analysis Chart (Example 1).

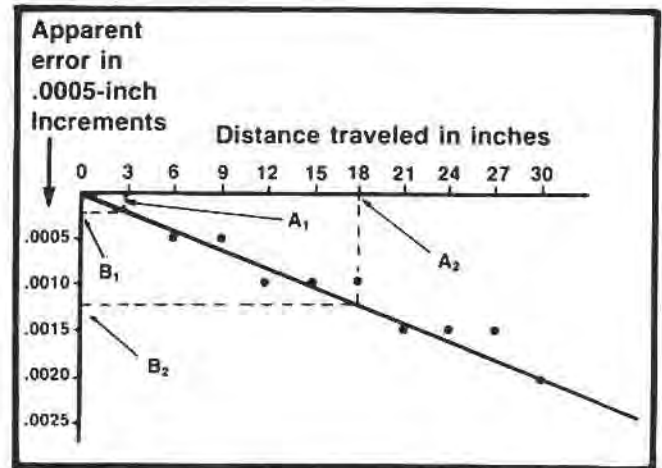

Figure 15b. Error Graph (Example 1).

Error Analysis (Example 2)

The same procedure was followed for a second axis (Figures 16a & 16b). From the plot of this axis, it can be seen that the error does not increase in the same manner as the first axis. This plot has several different error rates as indicated by the lines with different slopes. It is important when "best-fitting" straight lines are developed for these graphs, that they are based on a number of points spread over a significant interval, not just two or three points close together. If this concept of the "best-fitting" straight line is not used, true error slopes will not be shown.

Points close together can appear to have a large error for the amount of distance traveled. This is especially true for scales with relatively coarse resolutions. The scale measurement between close points can easily be off by one resolution. This "apparent" error occurs because of the digital nature of the scale, i.e. the readout can increment two units, after moving just slightly more than one full unit.

Single and multiple interval error compensation

TURNVISION™

Distance Measured by Standard	Measurement Displayed on Readout	Difference Between Measurements
0.0	0.0000	0
1.0000	1.0000	0
2.0000	1.9998	.0002
3.0000	2.9999	.0001
4.0000	3.9998	.0002
5.0000	4.9996	.0004
6.0000	5.9993	.0007
7.0000	6.9990	.0010
8.0000	7.9988	.0012
9.0000	8.9985	.0015
10.0000	9.9982	.0018
11.0000	10.9975	.0025
12.0000	11.9970	.0030
13.0000	12.9967	.0033
14.0000	13.9963	.0037
15.0000	14.9964	.0036
16.0000	15.9964	.0036
17.0000	16.9964	.0036
18.0000	17.9964	.0036
etc.	etc.	etc.

Figure 16a. Error Analysis Chart (Example 2).

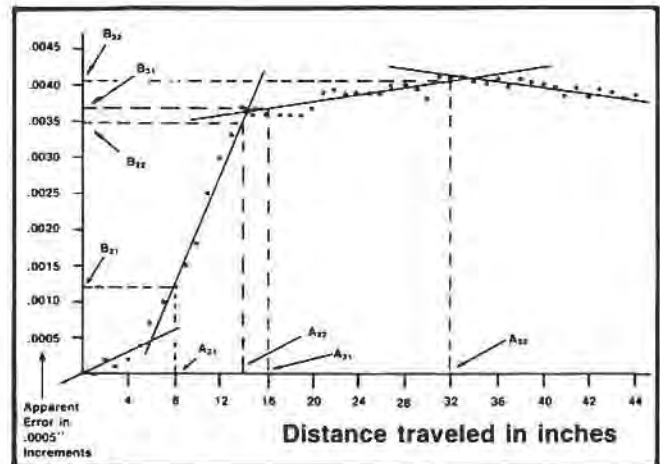

Figure 16b. Error Graph (Example 2).

Error compensation (cont.)

Example Requirements

As shown by examples 1 & 2, error compensation can demand different solutions. The first axis requires a constant error correction factor of 67 counts per million to correct for the measurement displayed. The second machine requires several different error correction factors in each of the different intervals to compensate for the errors.

TURNVISION has the capability to handle both types of error compensation. Single interval (linear) error compensation would be required to add in the constant correction factor over the entire length of the axis for example 1. Multiple interval error compensation would be best for example 2. With TURNVISION, up to eight different intervals, each with separate correction factors, can be used for each axis.

Measuring machine error

Methods for checking and measuring machine error

Laser Interferometer Method

- 1) Set up the laser, preferably at the tailstock, to give measurements of the actual distance traveled by a tool (in a tool holder).
- 2) At set intervals of 1/2", record the actual distance traveled (laser) to the distance indicated by TURNVISION. Then record the difference between the two measurements (set up a chart like Figure 16a).
- 3) Record measurements for the entire length of the axis.

Calibration Bar Method

- 1) On a piece of bar stock, cut steps every $\frac{1}{2}$ inch for the entire length of the axis to be checked. The precision of these measurements should be at least as fine as the resolution of the scale, installed on the axis being checked.
- 2) As each step is cut, record the dimension indicated on the readout display.
- 3) The bar should then be calibrated, with the precise measurements for each step recorded.
- 4) To determine the error compensation, subtract the readout distance from the calibrated bar distance, and plot the difference against the calibrated bar distance.

Single interval (linear) error compensation can be used on any axis. Multiple interval error compensation on TURNVISION requires scales with FTO reference marks. If the linear encoder does not have FTO signals, single interval error compensation must be used.

If the error analysis plot has a *single* best-fit straight line on the graph, single interval error compensation is the best choice for that axis. If the error analysis plot has *more than one* best-fit straight line, then multiple interval error compensation is the best choice to help compensate for geometry error.

Once machine error has been measured, TURNVISION can automatically calculate error correction values. These correction values can also be found manually, using error plots and mathematics. While TURNVISION's automatic routines are much quicker and easier to use, in some cases, the accuracy obtained is less than what can be obtained using a manual error analysis.

The following routine is the manual method to find error values for both single and multiple interval compensation. For single interval, the mathematics are done once for each axis being compensated. For multiple interval compensation, the same mathematical procedure will have to be done for each interval being used within an axis. The mathematics for both the manual and the automatic method involve finding the slope of each compensation interval and translating that value into parts per million (PPM). This value can then be used to adjust the display to compensate for machine geometry error.

Selecting single or multiple interval error compensation

Determining error correction values

Manual method

TURNVISION™

Calculating error correction values

To compute the error correction value manually:

- 1) On the error plot, draw a vertical line "A1" at one of the first distance measurements (Figure 17a below).
- 2) Draw a horizontal line "B1", where A1 intersects the best-fit straight line (the best-fit line represents the average error).
- 3) Draw another vertical line "A2" at one of the last distance measurements.

The lines chosen for "A1" and "A2" should be as far apart as possible for each average error line to achieve best results.

- 4) Draw another horizontal line "B2" where A2 intersects the best-fit line.

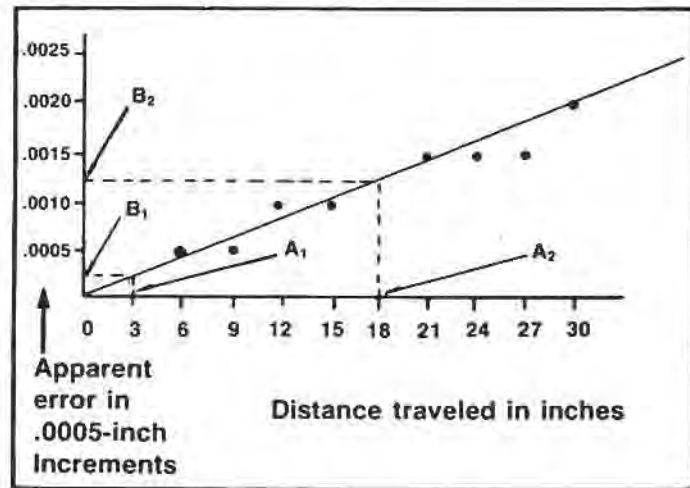

Figure 17a. Error Graph (Example 1).

- 5) Divide the distance traveled (A2 - A1) into the error (B2 - B1).
- 6) Multiply the result by 1 million to find the required error correction factor.

$$\begin{aligned}
 \text{ERROR} &= \frac{B_2 - B_1}{A_2 - A_1} \\
 &= \frac{.0012'' (-) .0002''}{18'' - 3''} \\
 &= \frac{.001}{15''} \\
 &= .0000667 \\
 .0000667 \times 1,000,000 &= 67 \text{ PPM}
 \end{aligned}$$

Figure 17b. Error Analysis (Example 1).

The procedure required to calculate the error correction factors for multiple intervals is the same, but must be performed for each interval. Figures 18a and 18b show examples of the chart and math involved for multiple interval error factor computations.

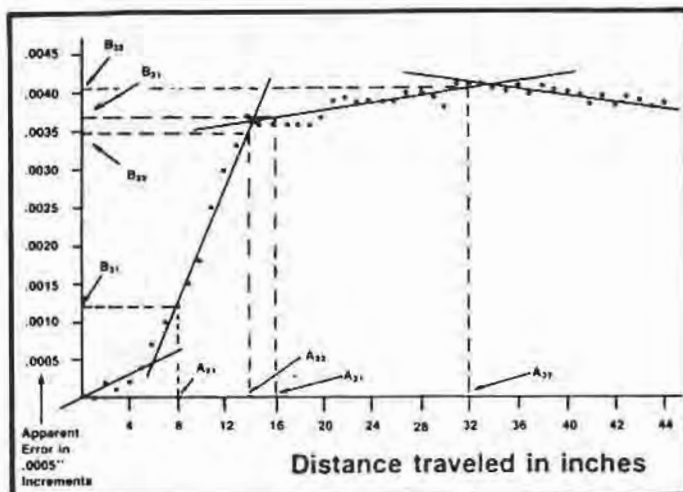

Figure 18a. Error Graph (Example 2).

$$\begin{aligned}
 \text{ERROR} &= \frac{BN_2 - BN_1}{AN_2 - AN_1} \text{ where N is the interval \#} \\
 &= \frac{.0035'' - .0012''}{14'' - 8''} \text{ for interval 2} \\
 &= \frac{.0023}{6''} \text{ for interval 2} \\
 &= .0003833 \text{ for interval 2} \\
 .0003833 \times 1,000,000 &= 383 \text{ PPM for interval 2}
 \end{aligned}$$

Figure 18b. Error Analysis (Example 2).

After error correction factors have been computed by the manual method (above), factors can be entered into TURNVISION's memory. To enter single interval error compensation factors proceed as follows:

- 1) Press the key.
- 2) Press the "SET AXES" menu key.
- 3) Enter the password.
- 4) Press the "ERROR COMPENSATION" menu key.
- 5) Press the desired axis key X, Z1, Z2, or Y.
- 6) Press the "EDIT" menu key.
- 7) Press the key to clear any current value.
- 8) Use the numeric keys to enter the compensation factor (must be in Parts per Million).
- 8) Press the "SAVE CHANGES" menu key.

Repeat for additional axes by pressing the "SELECT ANOTHER AXIS" menu key. Once error compensation factors have been entered, the axis should be checked against the measurement standard to assure that error compensation has been entered correctly and is working.

A measurement standard such as a laser interferometer or a calibration bar is necessary to use TURNVISION's auto error compensation routine. Set up the standard and proceed as follows:

- 1) Press the key.
- 2) Press the "SET AXES" menu key.

Setting up single interval error compensation within TURNVISION

Auto error routine for single interval compensation

TURNVISION™

- 3) Enter the password.
- 4) Press the "ERROR COMPENSATION" menu key.
- 5) Press the desired axis key.
- 6) Press the "AUTO ERROR COMP" menu key.
- 7) Move the axis to the beginning of the measurement standard.
- 8) Press the "Move Completed" menu key.
- 9) Move the axis to the end of the measurement standard.
- 10) Press the "Move Completed" menu key.
- 11) Enter the actual distance of the standard.
- 12) Press the "END Comp" menu key.

Repeat for additional axes by pressing the "SELECT ANOTHER AXIS" menu key. Once error compensation factors have been entered, the axis should be checked against the measurement standard to assure that error compensation has been entered correctly and is working.

Setting up multiple interval error compensation within TURNVISION

Establishing a home reference point is the first step in implementing multiple interval error compensation. The home reference point allows TURNVISION to define the same intervals for error compensation every time the unit is turned on (see page 23 for establishing a home reference point).

When TURNVISION is turned off, or power is lost due to a power outage, all axes position information is lost and the readout cannot tell if the encoder has moved. This loss of positional memory has a major effect on two areas within the unit.

The first area of impact is *position information* regarding the workpiece already mounted when power was interrupted. When power is restored, TURNVISION resets all axes to 0.0 for both the incremental and absolute displays. Therefore, the current positions of the axes, relative to the mounted workpiece, are lost until the axes positions are reset. This can be done by using the SET REF. POINT routine for each axis or by positioning the axes of the machine to known locations and manually presetting positions.

The other area that is affected by loss of positional memory is *multiple interval error compensation*. Specific segments of the scale, representing specific segments of travel on the machine, can each be given error compensation values. This specific relationship between the scale and actual machine positions requires a home reference point be found every time TURNVISION is turned on. The home reference point must be the same point which was defined prior to establishing the intervals for multiple interval compensation. The point must be relocated to re-establish the correct relationship between the defined intervals in TURNVISION's memory and the actual position of the machine. To find the home reference point proceed as follows:

- 1) Press the  key.
- 2) Press the "SET REF. POINT" menu key.
- 3) Press the corresponding axis key for the axis the home reference point is to be set.
- 4) Move the axis close to an FTO mark on the scale and press the "Ready" menu key.
- 5) Slowly move through the FTO mark on the scale in the *positive* count direction.

The FTO mark will only be sensed if the axis is moving in a positive count direction. Once the reading head has passed over an FTO mark on the linear encoder, TURNVISION's screen will indicate the home reference point has been found.

- 6) Press the "Finished" menu key or press the "Wrong Reference Point" menu key to select a different point.
- 7) Once the reference point is acceptable, it is extremely important to place a mark on the scale casing at the approximate location of the reference point (FTO). This will aid in locating the same FTO reference point quickly each time there is a need to find the home reference point.

These FTO reference marks and their purpose must be understood by the machine operator.

Repeat the above procedure for each axis requiring a home reference point.

Once a home reference point has been established, the individual intervals for multiple interval error compensation can be set. After intervals have been established along an axis, the corresponding error compensation values can then be entered.

Before entering multiple interval error compensation values, it is necessary to define interval boundaries or end points and how they can be found. The boundaries for intervals are referenced within the readout as 1 through 8. Each interval's boundary location is referenced from the home reference point which has been selected for that axis. The beginning of boundary 1 must be the most negative position physically possible on the axis (axis count direction and mechanical hard stops will define this point for each axis). With the beginning of boundary 1 established, all other interval boundary locations are determined by entering the end points for each interval. The end point of each interval is the beginning of the next interval.

When using a manual technique to determine error values, the interval end points should correspond to the crossing points of the average error lines (best-fit straight lines). These positions can be determined from the graph in relationship to the actual distance moved along the machine bed. The positions must be entered into the error compensation table within the SET SYS mode, ERROR COMPENSATION Menu, of TURNVISION.

Establishing the home reference point

Interval definition for multiple interval compensation

Manual techniques

TURNVISION™

Manual techniques (cont.)

An easy way to establish boundaries for intervals is based on the FTO home reference point position. This procedure results in a direct correlation between the position from gage blocks and the position from the FTO. Create an error analysis chart such as Figure 19a.

Column 1	Column 2	Column 3	Column 4
Axis Position to Home Reference Point	Gage Step Position	Readout Position	Difference Between Gage Step Position and Readout Position
-5.2310	0	0	0
-4.2310	1.0000	.9995	.0005
-3.2310	2.0000	1.9990	.0010
-2.2310	3.0000	2.9985	.0015
-1.2310	4.0000	3.9980	.0020
.2310	5.0000	4.9970	.0030
1.2310	6.0000	5.9955	.0045
2.2310	7.0000	6.9940	.0060
3.2310	8.0000	7.9928	.0072
4.2310	9.0000	8.9914	.0086
5.2310	10.0000	9.9897	.0103
6.2310	11.0000	10.9880	.0120
7.2310	12.0000	11.9866	.0134
8.2310	13.0000	12.9866	.0134
9.2310	14.0000	13.9867	.0133
10.2310	15.0000	14.9866	.0134
11.2310	16.0000	15.9867	.0133
12.2310	17.0000	16.9866	.0134
13.2310	18.0000	17.9870	.0130
14.2310	19.0000	18.9872	.0128
15.2310	20.0000	19.9873	.0127
16.2310	21.0000	20.9874	.0126
17.2310	22.0000	21.9876	.0124
18.2310	23.0000	22.9877	.0123
19.2310	24.0000	23.9879	.0121

Figure 19a. Error Analysis Chart.

Following the graph (Figure 19b), plot column 4 (Figure 19a) measurements to show error against distance traveled. When all the points have been plotted, draw in best-fitting straight lines based on a number of points spread over a significant interval, not just two or three points close together. Adjacent plotted points, if connected by a straight line, will not reflect true error slopes.

Manual techniques (cont.)

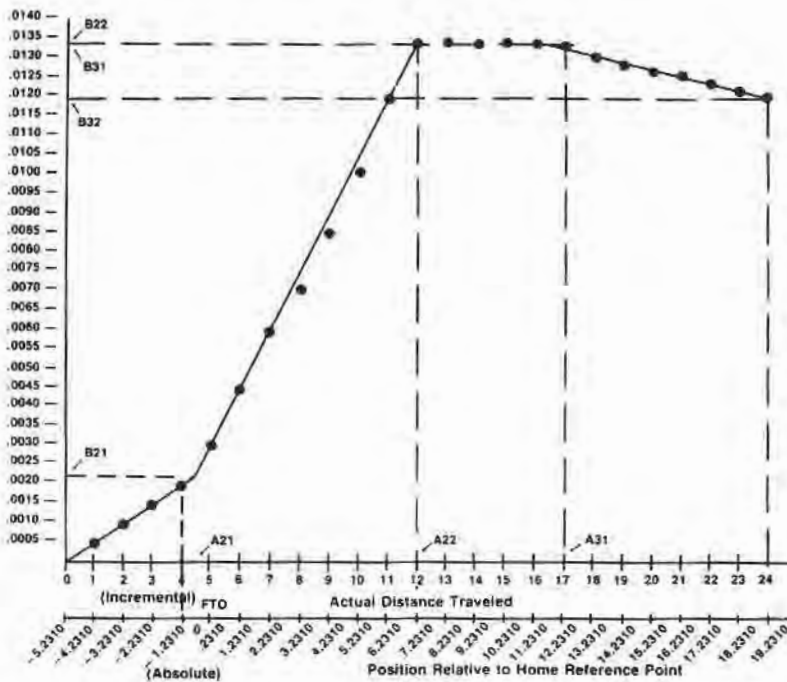

Figure 19b. Error Analysis Graph.

Another way to establish boundaries is to mark points on the scale case (home reference point and each true position error best-fit line crossing point). Then measure from each error best-fit line to the home reference mark. These measurements with the correct sign are the interval end points.

Follow the graph (Figure 19b) and plot column 4 (Figure 19a) as explained above in the first manual method.

The error correction factors must now be calculated for each interval. Follow the procedure below to calculate parts per million for each interval.

$$\begin{aligned}
 \text{ERROR} &= \frac{BN_2 - BN_1}{AN_2 - AN_1} & N &= \text{the interval number} \\
 &= \frac{.0134 - .00225}{12 - 4.3} & & \text{for interval 2} \\
 &= \frac{.01115}{7.7} & & \text{for interval 2} \\
 &= .001448 & & \text{for interval 2} \\
 .001448 \times 1,000,000 &= 1,448 \text{ PPM for interval 2}
 \end{aligned}$$

Figure 19c. Calculating Error Correction Factors.

Automatic multiple interval error compensation

After parts per million have been calculated, they must be entered into TURNVISION. Follow the "Entering error correction factors" below.

When using the automatic compensation routine, it is necessary to initially establish the approximate locations for each interval into which the axis is to be divided. Each selected interval (up to eight intervals for each axis) can be of any length. It is assumed that the axis has a consistent error factor within the specified area. Normally, the area(s) where the majority of machining is done will be divided into more intervals than the unused areas. Approximate locations are required so the calibrated standard can be roughly centered on each interval prior to being measured. The actual interval boundaries, as established by the auto error compensation routine, are established for each interval at one-half of the distance from the center of the calibrated standard to the center of the calibrated standard as located and measured, in the adjacent interval.

In the auto compensation routine, a calibrated standard is measured within each selected interval along the axis. For greater accuracy, the calibrated standard should be no less than $\frac{1}{3}$ of the length of that interval. The auto error routine will indicate the distance measured (moved), and "ask" for the actual (calibrated) distance moved. These numbers are used to calculate the error factor and boundaries for a particular interval. The standard is then moved to the center of the next interval and the procedure is repeated.

Entering error correction factors

To set multiple interval error compensation, using either the manually determined values or using the auto compensation feature, follow these steps:

- 1) In the SET SYS mode, press the "SET AXES" menu key.
- 2) Enter password.
- 3) Press the "ERROR COMPENSATION" menu key.
- 4) Select the axis to be programmed, by pressing an Axis key.

Note: The axis selected must have had a home reference point previously established (see page 32).

To place the interval boundaries and related error correction factors (found through the error analysis described on page 30) directly into the table through the EDIT routine, proceed as follows:

- 5a) Press the "EDIT" menu key.
- 6a) Beginning with interval #1, press the key.
- 7a) Enter the end point location of interval #1 using the numeric keys. The end point location is referenced from the home reference point (FTO). Following example 2, the end point location is the position on the "Position Relative to Home Reference Point" line, where the first interval ends (the dotted line intersects the FTO line).

- 8a) With the right directional key, move to the "PPM Comp" column and enter the desired Parts Per Million value for interval #1.
- 9a) Using the arrow keys, move through the table indicating the interval end points and the corresponding PPM compensating values. No end point is necessary for the last interval. When finished, press the "Save Changes" menu key.

Once an axis has been programmed, it should be checked again against the measurement standard to assure error compensation has been entered correctly and is working.

- 10a) Press the "SELECT ANOTHER AXIS" menu key and repeat the above steps, if necessary.

To enter boundaries and establish error factors using Auto Error Compensation, proceed as follows:

- 5b) Press the "AUTO ERROR COMP" menu key.
- 6b) Move the axis to the beginning of the measurement standard which must be located and roughly centered in interval #1. Press the "Move Completed" menu key when the axis is in position.
- 7b) Move the axis to the end of the measurement standard and press the "Move Completed" menu key.
- 8b) Enter the actual distance traveled (standard value) using the numeric keys.
- 9b) Press the "Go to NEXT Interval" menu key to continue defining intervals. Move the standard into the next interval and repeat steps 5b through 9b for interval #2. Continue until all intervals have been completed.
- 10b) After the last interval, press the "END Auto-Error Comp" menu key.

After an axis has been programmed, it should be checked against the measurement standard to assure that error compensation has been entered correctly and is working.

Repeat the above procedure for all required axes.

To edit for **single** interval error compensation, proceed as follows:

- 1) From the SET SYS mode, press the "SET AXES" menu key.
- 2) Enter password.
- 3) Select the "ERROR COMPENSATION" menu key.
- 4) Select the axis to edit by pressing the corresponding axis key.

Note: An axis which has had a home reference point defined, will initially display the multiple interval error compensation table. If single interval error compensation is used for the selected axis, interval #1 will be shown with the note "AXIS END" for the end boundary. To edit, use the procedure for multiple interval error, but change the PPM value for interval #1 only, or press the "SINGLE INTERVAL COMP" menu key and continue with the edit routine.

Editing procedures for both single and multiple interval error compensation values

TURNVISION™

Editing procedures (cont.)

- 5) Press the "EDIT" menu key. This will highlight the current error compensation value.

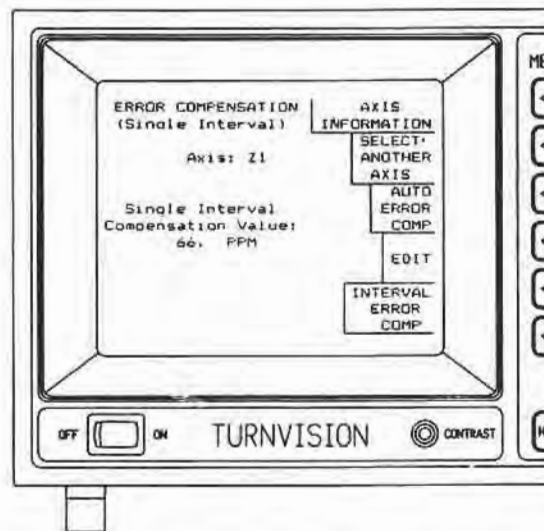

Figure 20. Single Interval Error Compensation Screen.

- 6) To change the current value, press the key and then the numeric keys to enter the correct value. Be sure to include the correct sign (+ or -) for the error compensation value.
- 7) Press the "Save Changes" menu key to put the new value into memory. This will return the display to the single interval screen for the selected axis. Verify the new value.
- 8) If other axes require editing, press the "SELECT ANOTHER AXIS" menu key and repeat steps 4 through 7, or press the "AXIS INFORMATION" menu key to return to the Axis Information screen.

To edit the values and/or intervals for axes with **Multiple Interval Error Compensation**, proceed as follows:

- 1) From the SET SYS Mode, press the "SET AXES" menu key.
- 2) Enter password.
- 3) Select the "ERROR COMPENSATION" menu key.
- 4) Select the axis to edit.
- 5) If the Multiple Error Compensation table appears, skip to step 6.

If just powering up, press "INTERVAL ERROR COMP" menu key. Press the "Find Reference Point" menu key. Move the axis near the reference point (FTO), press "READY". Move through the reference point. When the screen indicates the reference point has been found, press the "Finished" menu key.

- 6) Press the "EDIT" menu key.

Editing procedures (cont.)

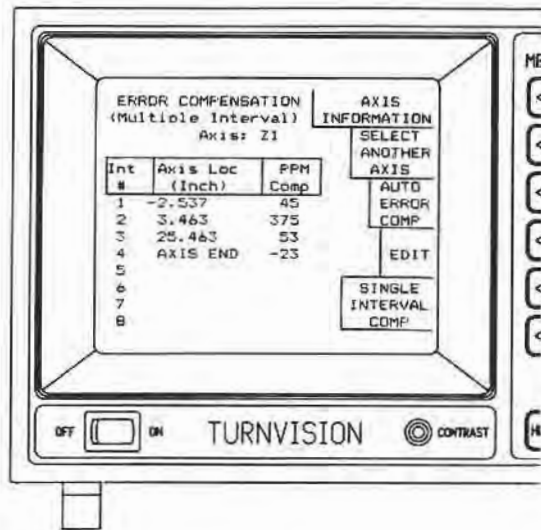

Figure 21. Multiple Interval Error Compensation Screen.

- 7) Use the arrow keys to select either the "interval end point (Axis Loc)" or the "PPM Comp" value. The item that can be edited is highlighted.
- 8) To change the current value, use the numeric keys to enter the correct value. Be sure to include the correct sign (+ or -) for both the "interval end point location" and the "PPM Comp" value.
- 9) When all changes have been made for the selected axis, press the "Save Changes" menu key. This enters the changes into memory and will return the display to the Error Compensation (Multiple Interval) screen for the selected axis. Verify the new values.
- 10) If other axes require editing, press the "SELECT ANOTHER AXIS" menu key and repeat steps 6 through 9 or press the "AXIS INFORMATION" menu key to return to the Axis Information Screen.

TURNVISION™

Powering up

When powered up, TURNVISION presents the operator with an opening "welcome" screen. This screen also includes the version number and software copyright information. In addition, every time TURNVISION is turned on, a start-up routine is automatically executed which checks information within its memory, checks RAM (Random Access Memory) for successful battery backup and checks the expansion slot module configuration for changes.

If TURNVISION's battery backup has failed, it will perform some internal housekeeping in preparation for functioning. This preparation defaults all software parameters to the factory default values (Figure 9, page 18).



Figure 22. TURNVISION Opening Screen.

The opening screen instructs the operator to "Press any key to continue", indicating that TURNVISION has completed the power-up routines. The next screen prompt will be one of the following:

Proceed to DRO - this prompt indicates that internal memory was successfully backed-up and that TURNVISION is ready to begin.

Proceed to SET SYS to establish a home reference point - this prompt indicates that internal memory was successfully backed-up and at least one axis is programmed using a home reference point that must be found at this time (as explained on page 23).

Proceed to SET SYS to verify the system parameters - this prompt indicates that the internal memory was successfully backed-up, but there has been a change in the hardware configuration. The SET SYS values should all be checked to ensure that they are in agreement with the actual hardware configuration. Page 18 goes through the necessary steps required to check installed parameters for axes.

Proceed to **SET SYS** to initialize the **System Parameters**. **Default settings have been made** - this prompt indicates the internal memory has not been successfully backed-up. All axis parameters must be re-entered. This procedure is covered on page 18. This prompt also indicates the unit's internal battery may be weakening and requires service. Notify your ACU-RITE distributor to arrange for the appropriate service procedures.

The DRO mode and program RUN/LEARN display

The DRO mode screen will be seen most often by the operator in day-to-day machining. The DRO Mode display consists of two major areas. The upper 75% of the screen is used to display axis position information, with the lower 25% of the screen displaying various pieces of information about the status of the unit.

It is beneficial for the operator to become very familiar with the layout of the DRO mode screen because it contains most of the information needed for machining.

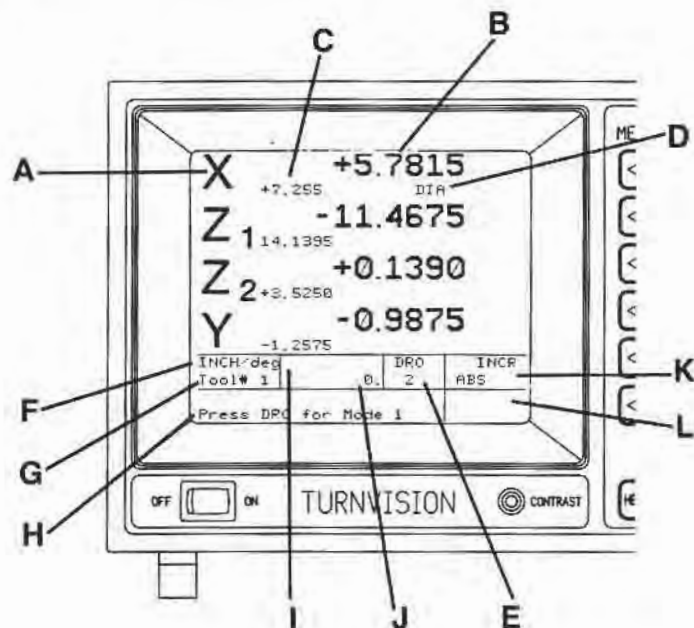

Figure 23. DRO Display Information.

The upper 75% of the screen contains the following information:

ITEM A - Individual Axis Label

TURNVISION is capable of displaying up to 4 axes of motion. These axes are labeled X, Z1, Z2, Y.

ITEM B - Primary Axis Position, Incremental/Absolute

The axis position displayed in the primary display position (larger numbers) can be either the incremental or absolute. The relative positions of the two pieces of display information are as indicated by Item M.

TURNVISION™

DRO mode display (cont.)

ITEM C - Secondary Axis Position, Incremental/Absolute

The display in this position is either incremental or absolute information, depending on which is in the primary position (see Item B).

ITEM D - Individual Axis Status Display

This area contains information corresponding specifically to that particular axis. It notes if the axis has been frozen or if a crossfeed axis position is displayed in diameter or radius measurement units.

Items A, B, C, and D are the same for all axes being displayed on the screen. The number of axes displayed depends on how the unit is configured in SET SYS mode which is covered on pages 18-21.

The size of the letters and numbers making up the information for items A and B is controlled by the number of axes being displayed. If three or less axes are being displayed, the information will be in a large size format. If four axes are being displayed, the information will be in a medium size format. A typical three-axis and four-axis example is shown below.

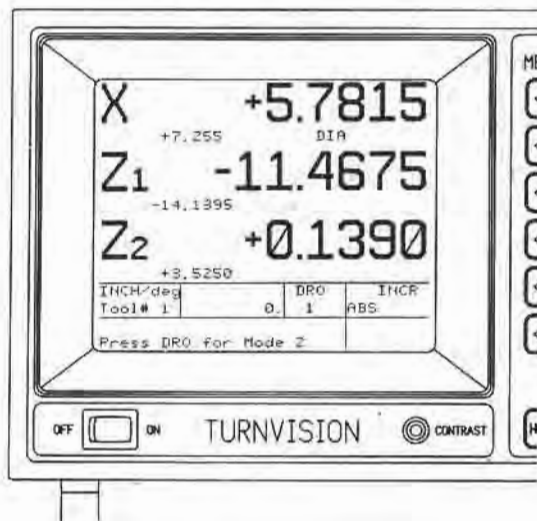

Figure 24a. Typical 3-Axis Display.

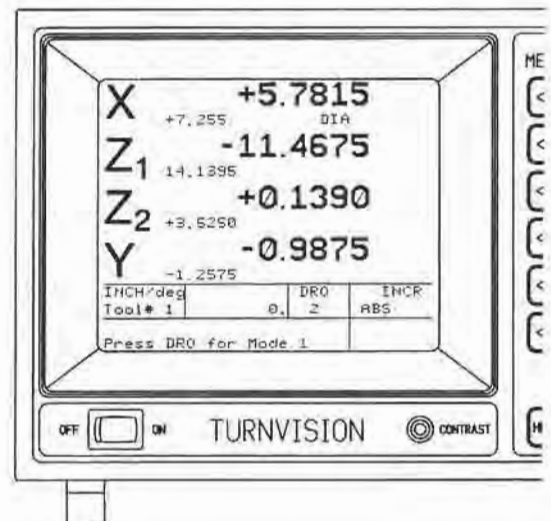

Figure 24b. Typical 4-Axis Display.

The size of the three-axis display is approximately 33% larger than the four-axis display. In both the larger and smaller formats, the display consists of eight full digits with the decimal points vertically aligned for all axes on the screen. The common decimal point position is located so the axis with the highest resolution has all of its decimal digits displayed to the right of the decimal point. If a number is larger than can be displayed with the common decimal point, the decimal point, for that axis only, shifts to the right. This will *decrease* the axis resolution, but *increases* the magnitude of the number that can be shown.

The lower portion of the DRO mode display contains general readout status information:

DRO mode display (cont.)

ITEM E - Current DRO Mode & Current Program Step Number
The DRO mode that is currently selected — DRO mode 1 or DRO mode 2. This area also gives the current program step number while a program is being “run” or “learned”.

ITEM F - Current Measurement Units
This section shows the current unit of measurement for the displayed axis or axes. This information pertains to both angular and non-angular axes. INCH or MM will be displayed for non-angular axes. DMS (degrees, minutes, seconds) or DEG (degrees) will be displayed for angular axes.

ITEM G - Current Active Tool Number
This display indicates the selected or current tool number. This tool number corresponds to a specific tool offset in TURNVISION memory.

ITEM H - Message Area
This area is used to prompt the operator on how to use certain DRO features and how to remedy certain error conditions. Normally, it will indicate how to select a different DRO mode. It is also used in conjunction with the TOOL # key and the STEP # key to be discussed on following pages.

ITEM I - Axis Preset Labels
This area displays axis labels (X, Z1, Z2, or Y) if any of the axes are being preset.

ITEM J - Preset Register Value
This area displays the preset value for the axes indicated in Item K or the last preset value used.

Items J and K contain the preset information. It is possible to preset or zero reset more than one axis at a time. The preset value can have up to eight digits, a decimal point and a sign.

ITEM K - DRO Menu Key

ITEM L - DRO Menu Key

Items K and L are the two menu keys available in the DRO mode. Their labels change depending on the special DRO function currently active.

The DRO mode

TURNVISION supplies two user-defined display modes: DRO display mode 1 and DRO display mode 2. With two modes, the operator can design two different display formats for machining. The operator may choose information to be displayed and eliminate information that is not needed. Each display mode is configured separately and can have different resolutions, near zero points, couplings, and number of axes.

TURNVISION™

The current DRO display mode is always noted on the screen in the center (Item E) of the readout status area. To change the mode, press the DRO key. The key toggles between the two DRO modes.

Note: If an axis is not being displayed, incoming information from the encoder is still processed and maintained internally. There is no loss of position information.

By setting different display resolutions for mode 1 and mode 2, the operator can work in one display mode using a coarse resolution for rough cutting and the other display mode using a finer resolution for finish machining.

The near zero feature gives the operator a visible indication of approaching zero. When the encoder moves into the programmed near zero region, the axis label flashes until the incremental display reaches zero, moves through zero, or the encoder leaves the near zero region. The near zero feature is reactivated and reset when the incremental display value is outside of the near zero "boundary". The near zero region is valid for approaches made from either direction. The near zero warning is set while configuring the DRO display modes as explained below.

The DRO display modes are configured in the DRO mode and SET SYS mode with the special function keys and the menu keys. The areas that must be configured are the axes to be displayed, display resolutions, and near zero points.

To set the DRO display mode configuration proceed as follows:

- 1) Press the  mode key.
- 2) Press the "SET DRO DISPLAY" menu key.
- 3) Press the display mode to be set (either mode 1 or mode 2).
- 4) Select the axes to be displayed in the order they are to be displayed on the screen. Use the arrow keys to move the highlight bar to the desired screen position below "Axes Displayed:".

Press the  key to remove any current axis.

Press the desired axis key for the screen position highlighted.

The "ADD", "SUBTRACT", and "AVERAGE" menu keys pertain to multiple scale coupling explained on the following pages.

- 5) Press the "Display Format" menu key to access the Round Off Values (display resolution values) and the Near Zero Values table.
- 6) To set the Round Off Values, use the arrow keys to highlight the axes desired and then use the "Finer" or "Coarser" menu key to select the value. The values are "mm" and "decimal degrees" or "inches" and "decimal degrees". Units are indicated at the top of the screen and can be changed by pressing the INCH/MM key. *The displayed resolution should never be set finer than the encoder resolution (Figure 25).*

Near zero display indicator

Setting the DRO display modes

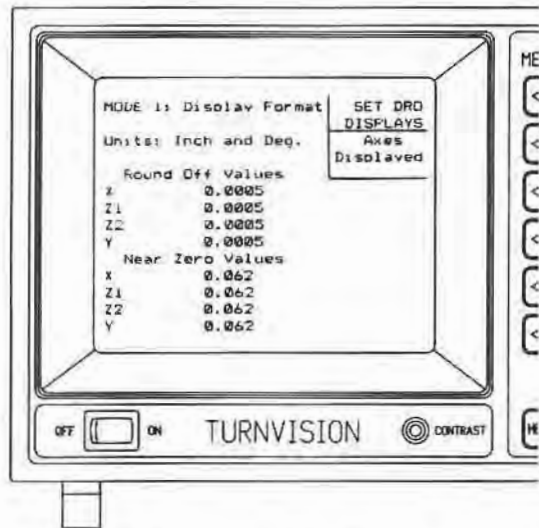

Figure 25. Setting DRO Display Modes.

- 7) To set the Near Zero Values, use the arrow keys to highlight the axis desired. Press the key to erase any current value and the numeric keys to enter the beginning of the near-zero boundary desired.
- 8) Press the "Axes Displayed" menu key to set multiple scale coupling or press the "SET DRO DISPLAYS" and then "SET SYS" menu key to set multipliers (explained on page 43) or to exit setting DRO modes.

Multiple scale coupling

Multiple Scale Coupling (MSC) allows the capability of mathematically combining the signals from two parallel linear encoders. The two encoder signals are electronically added, subtracted, or averaged to display one resultant motion, relative to the workpiece.

TURNVISION has three ways of performing Multiple Scale Coupling between axes. Coupling can be done using the Set System mode, the DRO mode, and/or the PROG mode.

Coupling established in the SET SYS mode (SET DRO DISPLAYS routine) can be displayed in any position of the DRO display. This method of MSC remains in existence until changed in the SET DRO DISPLAYS routine. The coupling can be added, subtracted, or averaged.

SET SYS coupling

To establish multiple scale couplings in the SET DRO DISPLAYS routine, proceed as follows:

Note: The following routine can be programmed while setting the DRO DISPLAYS modes, step 4 on page 43.

- 1) From the SET SYS mode, press the "SET DRO DISPLAYS" menu key.

Multiple scale coupling (cont.)

- 2) Select the DRO display mode (1 or 2) in which coupling is to be displayed.
- 3) Use the arrow keys to highlight the axis position selected to display coupling. Press the **Clear** key.
- 4) Press the **AXIS CPLE** key.
- 5) Use the axis keys to select the first axis to be coupled.
- 6) Select the coupling function (ADD, SUBTRACT, AVERAGE), by pressing the corresponding menu key (Figure 26).

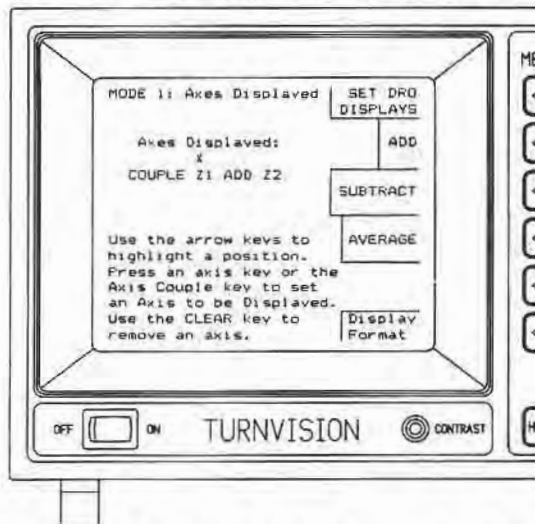

Figure 26. Multiple Scale Coupling (MSC).

- 7) Press the second axis key (to be coupled with the first).
- Repeat steps 3 through 7 for any other couplings required.

Immediate coupling is established with the AXIS CPLE key while in the DRO and PROG Modes. An advantage of this method is that coupling can be established and discontinued easily within the DRO and PROG modes. Immediate mode coupling remains visible only for the present DRO or PROG Mode. The coupling is erased if the display is changed to another mode (including another DRO mode). The coupling is not erased when the HELP mode is accessed.

Immediate multiple scale couplings include the following limitations:

1. Only two axes may be coupled together.
2. The coupling must be either addition or subtraction.
3. Only one immediate mode coupling can be operational at a time.

An immediate mode coupling is displayed in the last axis position in the DRO and PROG Mode screens. If there are four axes being displayed, the coupling will override the fourth axis. The fourth axis remains active and will reappear when the coupling is removed.

Immediate mode coupling

To establish immediate mode couplings, using the AXIS CPLE key, proceed as follows:

- 1) From the DRO mode, or PROG RUN/LEARN, press the  key.
- 2) Use the axis keys to select the first axis to be coupled.
- 3) Using the menu keys (ADD, SUBTRACT), select the coupling function.
- 4) Select the second axis to be coupled.

The immediate mode coupling can be erased at any time by changing the DRO display mode, leaving the DRO mode, or by pressing the AXIS CPLE key. When the coupling is erased, the display configuration (as it appeared prior to the coupling) will return. While programming immediate coupling, the sequence can be aborted by pressing the AXIS CPLE key.

Comparing SET SYS and immediate mode coupling

With either method of MSC, a coupling cannot be identified as a unique axis for presetting, edge finding or zero resetting. Presets, however, made on an axis which is included in the coupling will affect the coupling position.

Near zero indication capabilities remain active while axes are coupled. The near zero boundary for a coupled axes display, established in the SET DRO DISPLAYS routine, is set as part of that routine. The near zero boundary for immediate mode couplings is set to zero (not active).

The display resolution for permanent couplings is set in the SET DRO DISPLAY routine. The display resolution for immediate mode couplings is defined as the coarsest resolution of the axes being coupled.

Display multipliers

Display multipliers are used to scale a part from an existing drawing. This feature is especially useful when machining mirror images; a multiplier value of negative one (-1) can be used to generate a mirror image part. Individual axis multipliers are used for machining molds or patterns requiring expansion and contraction factors.

To set display multipliers proceed as follows:

- 1) From the SET SYS mode, press the "SET DRO DISPLAYS" menu key.
- 2) Select the "Multipliers" menu key.
- 3) Highlight the desired axis with the arrow keys.
- 4) Erase the existing value with key.
- 5) Enter the new value with the numeric keys.

All displayed axes MUST have a multiplier. During normal machining, the multiplier will be "1". No axis should have a value of 0.

Multipliers are in effect for DRO display modes 1 and 2, but the PROG mode requires multipliers be entered as part of the program.

Vectoring is a unique and useful routine that allows the compound rest to be the tool mover, while TURNVISION does the trig functions to indicate the compound movement as two separate measurements — a diameter movement and a length movement. These two movements are separated and indicated in the respective crossfeed and longitudinal axes displays.

The vectoring routine is especially helpful when threadcutting because the operator can read the true depth of cut on the readout display **while** machining. The operator no longer has to stop machining to measure thread depth.

This feature is also useful when cutting a taper. If the operator is only given the taper angle on a drawing, TURNVISION can internally calculate the trig function and indicate in the readout display, both the diameter and length measurements. Figure 30a shows the principle axes superimposed on a lathe bed to help clarify the principles of vectoring.

When using the vectoring routine, the Y-labeled axis will always be the compound rest axis and the X-labeled axis is always the crossfeed axis (90° to the center axis of the lathe). The compound angle can be referenced from either the crossfeed **or** longitudinal axis (not all compound rest zeros are referenced from the same axis). The longitudinal movement of the vector routine can be added to either the Z1, Z2, or both axes.

The principle of vectoring

Vectoring in threadcutting and tapering

Setting the vectoring routine

Setting the compound rest angle is similar to presetting functions; an **incremental** preset adjusts the present angle, while an **absolute** or **reference** preset replaces the angle with the preset value. Note: There is only one display for the Y-axis showing the vector angle. Presetting the Y-axis during vectoring sets the vector angle only — a distance or position preset cannot be made.

To set the vectoring routine, proceed as follows:

- 1) Press the  key.
- 2) Press the "SET AXES" menu key.
- 3) Enter password.
- 4) Press the "USE VECTORING" menu key.
- 5) Select the axis that the compound rest angle will be measured from.
- 6) Use the down arrow key to move the highlight bar.
- 7) Select the axis or axes the longitudinal component of the compound rest is to be vectored into.

Once vectoring is set, the DRO display will indicate vectored axes.

To cancel vectored axes, return to the SET SYS mode and repeat steps 2 through 4 above. Use the down arrow key to move the highlight bar to the longitudinal component entry. Press the "NONE" menu key. Vectoring is now cancelled.

Note: If the vectoring feature is toggled on and off, workpiece zero will have to be re-established.

Machining to zero

TURNVISION was developed with a specific machining principle; *always machining to zero*. By machining to zero, the operator does not have to remember a long number at which to stop the cut. When TURNVISION's incremental display reads zero, the preset movement has been completed.

TURNVISION makes machining to zero possible by presetting the axis displays. There are four different types of axis presetting: Absolute, Incremental, Reference, and Zero Reset.

Absolute presetting

Absolute presetting changes the absolute display to the entered value and zeros the incremental display. Absolute presetting specifies the distance from the current tool position to workpiece zero. In standard machining, most operations are performed relative to workpiece zero. Therefore, if it is changed and not indicated on the work print, it could create confusion for the operator.

Incremental presetting

Incremental presetting is used to indicate a distance from the current tool position to a desired tool position. Typically used in point-to-point machining.

TURNVISION™

Reference presetting sets the incremental display to the distance required to get to a position relative to the workpiece zero, rather than from the current position. Reference presetting automatically subtracts the desired position from the current tool position. Example: Assume the tool position in the X-axis is located 6 inches in the positive direction from workpiece zero, and the operator wants to move it so that it is positive 8 inches from workpiece zero. The operator would enter X (the axis key), 8 (the preset value) and REF. Initially, the X-axis incremental display would read “-2 inches”. Therefore, the X-axis table slide, must be moved in the positive direction to get to zero. When the move has been made, the incremental display for the X-axis will read “zero” and the absolute display will show “+8 inches”. **When a REF preset is entered, the value of the incremental axis is changed to show the distance needed to achieve the reference preset position (the absolute axis is unaffected).**

Reference presetting

The ZERO RESET key is a special key used with various presetting functions. It is only used to preset the value of zero in the display. Zero Reset is always used with either the absolute or the incremental preset function.

Zero resetting

Zero Reset, when used with the incremental function, zeros the incremental display, but does not affect the absolute display.

Zero Reset, when used with the absolute function, zeros both the incremental and absolute displays at the same time. Zero Resetting the absolute display is normally done only once on any workpiece because it moves the position of workpiece zero.

Presetting is a three step operation: an axis selection, presetting a value, and presetting a function. Any of the following keystroke sequences can be used to preset an axis (or axes):

Axis presetting procedures

- 1) **AXIS SELECTION, PRESET VALUE, PRESET FUNCTION**
- 2) **PRESET VALUE, AXIS SELECTION, PRESET FUNCTION**
- 3) **PRESET VALUE, PRESET FUNCTION, AXIS SELECTION**
- 4) **PRESET FUNCTION, PRESET VALUE, AXIS SELECTION**

If axis selection is specified first in the sequence, the axis label will appear in the axis preset area. If, however, the preset function is specified first, its name (REF, ABS, INCR) will appear in the axis preset area.

The preset value consists of up to eight digits (ten spaces including the decimal point and sign) and may be entered with a maximum of seven decimal places. No more than one zero preceding the decimal point may be used. The degree of accuracy of the preset value (as indicated by the number of digits to the right of the decimal point) cannot be greater than the programmed resolution entered into the SET SYS mode, SET PARAMETERS table at time of installation. If a greater precision value is entered, it will be rounded off to match the linear encoder or display resolution. Rounding off will be determined and made for each axis when using multiple presets.

Only one preset value and preset function can be used for any one preset operations, but more than one axis can be selected. Each axis selected for a particular presetting function has its label displayed in the axis preset area. Multiple axis presets can be done while using sequences 1 and 2 (see axis presetting procedures on page 49), when the axis selection is not the last item in the sequence. The CLEAR key can be used to remove the entire contents of the preset register.

When a number is entered into the preset register, it remains there until another number is entered or it is cleared by the CLEAR key. This means that the last preset value may be reused (for example, several grooves located an equal distance apart) in subsequent preset operations without having to re-enter the value.

An angular preset can be made in DEG (degrees) or DMS (degrees, minutes, seconds). If a single decimal point is used, it is assumed to be DEG (degrees); this is the standard input method. If the DRO mode is in DMS units, a DMS preset can be made using multiple decimal points.

Example: $123^{\circ} 42' 18'' = 123.42.18$

If only one decimal point is used it is assumed to be DEG input.

Example: $123.42 = 123^{\circ} 25' 12''$

When an axis presetting sequence begins, a "Preset" message will appear in the general message area at the bottom of the screen. The menu keys available in the DRO Mode status will be labeled "FREEZE" and "CANCEL".

The FREEZE feature

The FREEZE function is used only in conjunction with absolute presetting and zero resetting. The "FREEZE" menu key becomes available whenever a preset operation is started. This feature permits the operator to select one or more axes and "freeze" the current display values. This is especially useful if the operator wants to write down the current values on the display without the risk of changing them by bumping the table. It is also useful if the operator wants to move the table out of the way to measure a cut and compare it with the displayed value. When the freeze function is active, it will maintain the frozen axes' displays on the screen even if the axes are moved. If the axes are moved, the information is not lost; it is recorded and the display is updated once the freeze has been "thawed", "cancelled", or a preset has been completed. When a display has been "frozen", the "THAW" menu key will cancel the operation. Incremental and reference presets can also be made to frozen axes, but their net effect is as if it hadn't been frozen.

An example of the FREEZE feature with the absolute preset function is when an operator takes a trial cut and wants to set the X absolute display to establish the initial dimension. Before moving the tool away from the part, the operator would press the X-axis key, then the "FREEZE" menu key. The X-axis would freeze its display, thereby allowing the operator to pull the tool back without losing the cutting position. Next, the operator would measure the part, enter the dimension as a preset value, and press the ABS function key.

TURNVISION™

The displayed position at which the "FREEZE" menu key was pressed, would be replaced by the entered preset dimension and the display would become "unfrozen". The tool would no longer be at the cutting position, but the current tool position would be displayed, considering the new location of workpiece zero just entered.

All machinery operations use a variety of tools. Therefore, it is helpful to have a means of referencing tool cutting edges to a common tool point, or to each other, for each axis. This referencing process, called *tool offsets*, can be used to update the unit for a tool change. Updating maintains the true position of the cutting surface in relation to the workpiece.

Example: A typical turret style tool holder is shown in Figure 27. As the second tool is rotated into position, the true position of the cutting surface changes. By using tool offset and indicating which tool is currently in cutting position, TURNVISION will display the true position of the cutting surface with respect to the workpiece.



Figure 27. Tool Offset Illustration.

Before a tool can be selected as the current tool, offset values for the tool must be assigned. Each tool can have offset values for any two axes at one time. Offsets can be entered through the keyboard as shown in the following paragraphs, or TURNVISION can accurately compute values through the Auto Offset routine explained on page 52.

To enter tool offset values proceed as follows:

- 1) Press the  key.
- 2) Use the "Edit Tool Offsets" menu key.

- 3) Select the tool number using the arrow keys or press the key and enter the number, There are 24 different tool numbers available.

NOTE: While machining, there must always be an active tool. The effects of tool offsetting can be removed by selecting a tool with offsets of zero. Therefore, when assigning offset values, enter a tool with offsets of zero.

- 4) Enter the axis or axes requiring offset values.
- 5) Enter the offset value with the numeric keys, decimal point and +/- key. The offset values may be entered in English or Metric units. The display is toggled from English to Metric with the INCH/MM key.

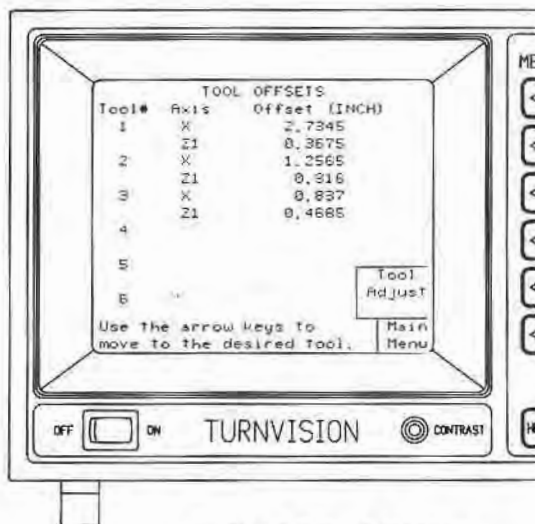

Figure 28. Tool Offset Screen.

When tool offsets are removed from an axis display, the resulting display is a value relative to the common tool point from which the tool offset was developed. The displayed value will have limited importance unless it is used with another tool with offsets generated using the same common tool point.

Auto tool offsets

Absolute offset dimensions for one or two axes can be determined through TURNVISION's Auto Tool Offset routine. The tool is used to make a trial cut and then measured to find true position, or the tool is "touched" to a known reference surface. The tool's true position is entered into the unit and the offset is determined and stored automatically within TURNVISION.

To use the Auto Tool Offset routine, proceed as follows:

- 1) Press the **Set Tool** key.
- 2) Press the "Auto Tool Offsets" menu key.
- 3) Enter the tool number to be compensated.

TURNVISION™

- 4) Press the "Compensate Tool" menu key.
- 5) Enter the axes of the tool.

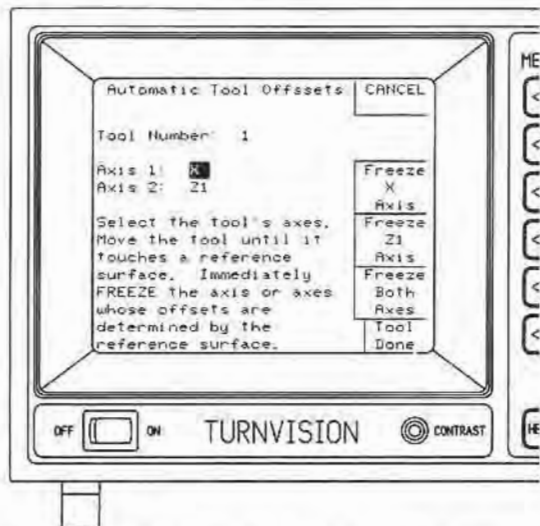

Figure 29a. Automatic Tool Offset Screen 1.

- 6) Move the tool until it touches a reference surface.
- 7) Freeze the axis or axes which offsets are determined by the reference surface by pressing the appropriate menu key.
- 8) Use the reference surface to measure the absolute position of the tool's cutting edge and enter the position by using the numeric keys. Note: Axes configured as crossfeed axes, can be entered in radius or diameter units — use the RAD/DIA key to toggle the display.
- 9) Press the "Measurement Complete" menu key.

TURNVISION will compute the offset values from the entered information and then return to the Freeze Axis screen to allow the second axis to be frozen and measured if it was not done as part of the first sequence.

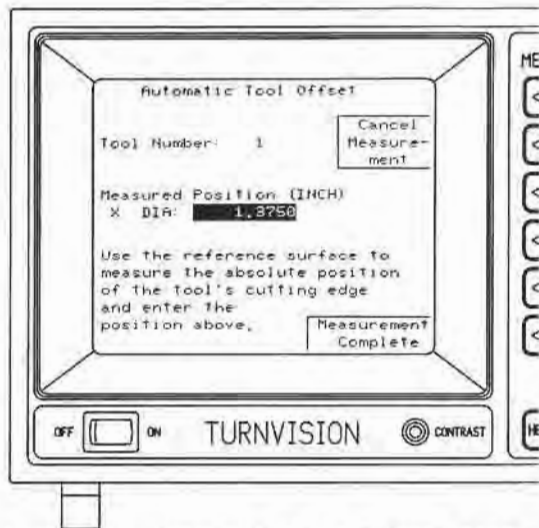

Figure 29b. Automatic Tool Offset Screen 2.

- 10) After both axes have been completed, press the "Tool Done" menu key. If another tool is to be compensated, repeat the procedure. If compensation is complete, press the "Main Menu" menu key.

From the Main Menu, the Edit Tool Offsets routine can be accessed to review and/or edit values obtained through the Auto Offset routine.

Tool adjust

The tool adjust feature gives the operator an easy way to compensate for tool wear or resharpening.

To adjust for tool wear or resharpening proceed as follows:

- 1) Press the  key.
- 2) Press the "Edit Tool Offsets" menu key.
- 3) Press the "Tool Adjust" menu key.
- 4) Enter the tool number to be adjusted.
- 5) Use the down arrow key to move the highlight bar to the "Adjustment" field.
- 6) Enter the adjustment value and press the "Make Adjustment" menu key. Only the axis whose adjustment is highlighted is affected by the "Make Adjustment" menu key.

TURNVISION automatically calculates the new offset values.

The calculator mode

TURNVISION's built-in calculator provides the capabilities of an eight digit, four-function calculator. TURNVISION also features the ability to automatically calculate taper angles and rpm values. The operator does not need to leave the machine to calculate simple math operations. The calculator mode can be accessed from any TURNVISION mode by pressing the CALC key. Numbers entered in a calculation may be entered with the numeric keys or copied from the current value in the DRO preset register.

Keys used in the calculator mode are as follows:

(Numeric keys)	The numeric keys are used to enter numbers in manually.
(+/- key)	The plus/minus key toggles the value sign from + to -.
(decimal pt key)	The decimal point key can be used when entering numeric values.
(CLEAR key)	The clear key is used to erase a current number. Press twice to erase the entire calculation (preset remains unchanged).

While in the main calculator mode, all other TURNVISION front panel keys (except menu keys) cannot be engaged.

There are two menus controlled by the menu keys. The far right menu keys contain the arithmetic function keys and "equals" sign. To toggle to the second set of menu keys, press the top menu key. The arrow on top of the screen will extend and highlight the three function menu keys. These menu keys are used to access the DRO display preset register.

PRESET STORE	Copies the value displayed as the operation result to the preset. The old preset value is overwritten.
PRESET RECALL	Copies the preset value to one of the number entry fields.
ADD TO PRESET	Adds the value displayed as the operation result to the preset.

A unique feature within the calculator mode is the ability to automatically calculate the taper angle on a turned piece by touching it in two places with a cutting tool or dial indicator. To access the taper calculator, press the CALC key while in the standard calculator mode.

Taper calculator

To calculate a taper angle proceed as follows:

- 1) Press the  key while in the standard calculator mode.
- 2) Choose axes to be tapered. This step can be omitted if the default axes, X and Z1 satisfy the needs of the operator. If the axes need to be changed, press the "Select Taper Axes" menu key.

- 3) With a cutting tool or dial indicator, touch one point on the taper. Press the "Record First Point" menu key.

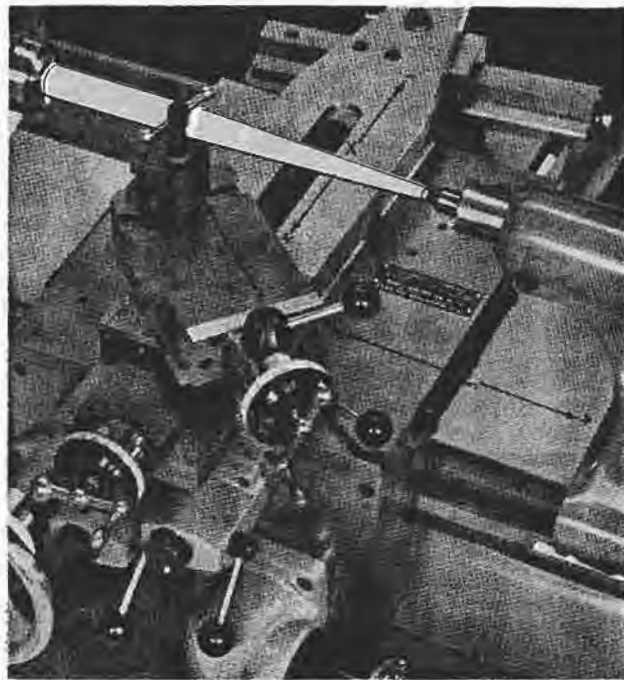

Figure 30a. Turning a Taper.

- 4) Move to a second point on the taper and press "Record Second Point" menu key. TURNVISION will now calculate the taper angle.

When the calculation is complete, four values will appear. Both axes' angles are displayed in degrees, minutes, seconds (top measurement), and decimal degrees (bottom measurement). The values represent the angle between the tapered edge and the indicated axis (see Figure 30b).

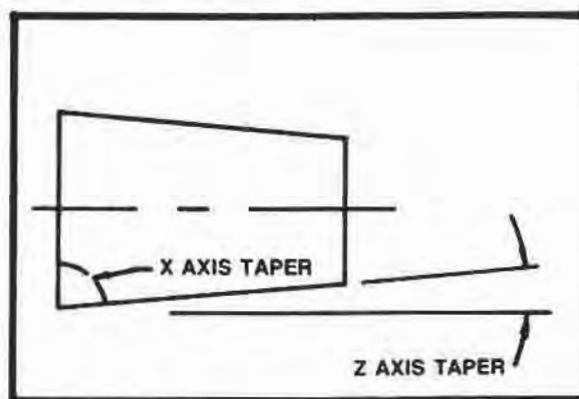

Figure 30b. Taper Angles.

TURNVISION™

The range of values for each axis is between 0 and 90 degrees of taper. The sum of both will *always* be 90 degrees.

Coordinates for a taper calculation can also be entered manually. To manually enter taper points, proceed as follows:

- 1) Press the **CALC** key while in the standard calculator mode.
- 2) Press the "Enter Taper Points" menu key.
- 3) Enter the "First Point" measurements using the numeric and decimal point keys. The coordinates may be entered in inches or metric (INCH/MM key) and can be entered as a radius or diameter (RAD/DIA key).
- 4) Move the highlight bar to enter the "Second Point" measurements.
- 5) Press the "Compute Taper" menu key.

Taper angles, representing the angle between the tapered surface and the indicated axis, are calculated and displayed in two formats — degrees, minutes seconds and decimal degrees.

Within the calculator mode is an RPM calculator that computes lathe RPM requirements. Correct cutting speeds are important to good tool life and efficient machining. Excessive high cutting speeds will cause overheating and premature wear of the tool. Slow cutting speeds reduce productivity and increases manufacturing costs. The RPM calculator makes it easy for the operator to quickly calculate the correct RPM for maximum productivity.

RPM calculator

To use the RPM calculator proceed as follows:

- 1) Press the **CALC** key to enter the calculator mode.
- 2) Press the **CALC** key two more times to toggle through the taper calculator and access the RPM calculator.
- 3) Use the numeric keys to enter the workpiece diameter ("DIA"). The diameter can be put into the calculator in inches or mm. Change the units by pressing the **INCH/MM** key.
- 4) Use the down arrow key to highlight the value for "Surface Speed in Meters per Minute" (SMM) (Figure 31).

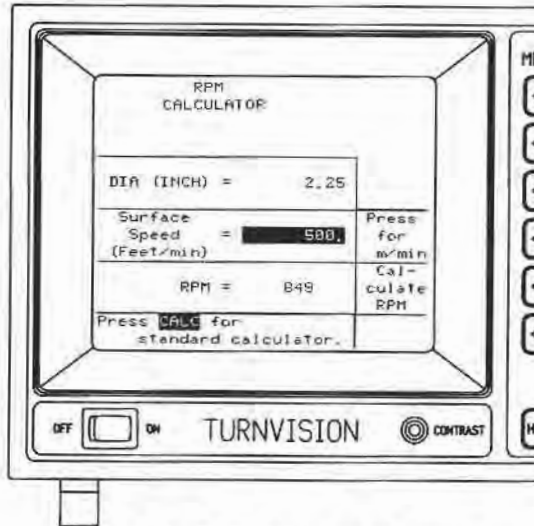

Figure 31. RPM Calculator Screen.

- 5) Use the numeric keys to enter the Surface Speed. Press the menu key to the right to toggle between Surface Feet per Minute and Surface Meters per Minute.

The surface speed values are usually selected from standard tables which indicate the recommended cutting speed, the stock material, and the type of cut (rough or finish). TURNVISION has such a table in memory. To access the table, press the **Help** key and then the "Surface Speed Table" menu key.

NOTE: All tables are based on optimum machining conditions.

- 6) To calculate the RPM (once the DIA and "Surface Cutting Speed" have been entered) press the "Calculate RPM" menu key.
- 7) Press any mode key to exit RPM calculator or press the **CALC** key to return to the calculator.

TURNVISION has a convenient routine to reset all parameters, making the unit "fresh out of the box" again. The "RESET ALL MEMORY" routine within the SET SYS mode will erase TURNVISION's entire memory and reprogram the factory defaults (Figure 9, page 18) for all parameters.

CAUTION

IF "RESET ALL MEMORY" IS USED, ALL PROGRAMS AND TOOL OFFSETS ARE LOST.

To reset all memory proceed as follows:

- 1) Press the **Set Sys** key.
- 2) Press the "MISCELLANEOUS" menu key.

Resetting TURNVISION memory

TURNVISION™

- 3) Press the "RESET ALL MEMORY" menu key.
- 4) Enter password.
- 5) Read the warning and verify the intent to reset all memory.
- 6) Read the second flashing warning and again verify the intent to reset all memory.
- 7) The opening screen will appear indicating that all memory has been erased and factory defaults have been reprogrammed.

At this point, all home reference point locations, axes parameters, axes labels, error compensation values, tool offsets, display formats and machining programs will have to be re-entered as required.

TURNVISION's program capabilities make the machining of repetitive parts easily and efficiently. A program displays the information the operator requires to machine a part without referring back to a print. Program memory can hold 8 programs with a total of 200 steps.

Programming is comprised of 3 functions:

Programming - contains routines to enter new programs, view entered programs, edit existing programs, and erase old programs.

Running a Program - Entered programs are run in the PROG mode. While running a program, every step involves the operator machining to zero.

Learning a Program - This feature allows the operator to enter a program by machining a part. Subsequent parts can then be machined with the learned program by running the program (above).

All presets applicable to an operation, conform to the philosophy of machining to zero. With this idea, the machining operation is not complete until the displays read zero. This eliminates the possibility of the machinist getting lost during an operation — the constant known destination is always zero.

When creating a program, each axis is programmed with a multiplier. This is useful when machining mirror images or allowing for differing expansion and contraction factors. All real numbers (positive or negative), up to six digits to the right of the decimal point, can be used as a multiplier. It is important that the multiplier value is never zero.

Examples:

- 1) When working from a full size, scaled drawing, a multiplier of "1" must be used.
- 2) When machining a mirror image part, a multiplier of "- 1" would be used.
- 3) When working from a drawing two times larger than the actual part, a multiplier of ".5" would be used.

Z-axis coupling is a feature that couples (mathematically combines) the Z1 and Z2 axes while running or learning a program. The operator no longer needs to preset each axis to make a combined movement.

When creating a program ("EDIT NAMED PROGRAM"), Z-axis coupling is activated after setting program multipliers:

- 1) Move the highlight bar to the "Z Coupling" field. Menu keys with available choices will appear.
- 2) Press the desired function — "Z1 + Z2", "Z1 - Z2", or "OFF".

Programming with TURNVISION

Program step definitions

Multipliers

Z-axis coupling

TURNVISION™

Program step information

To cancel Z-coupling, the operator must edit the program and repeat the two steps above. The function must be "OFF".

While using Z-axis coupling there are a few things to note:

While running or learning a program, the Z1 and Z2 axes, will not have individual axis displays.

A manual MSC can be used in addition to the Z coupling (see page 44).

While learning a program:

All presets are recorded as the couplings absolute position and is learned as a Z1 preset.

The near zero value is set to zero, and the display resolution is set to the coarsest of the Z1 and Z2 encoder resolutions.

While running a program:

If a preset is made to either the Z1 axis or Z2 axis, it will affect the **coupled** display.

The near zero and display resolution values are taken from the last Z1 or Z2 preset in the program step.

Each program step contains seven areas of information:

Axis - Each step can be programmed for two axes, each with a separate preset, function, round off value, and near zero flashing point. However, only axes which are to be machined with the same tool can be used in the same step.

Axis - Each step can be programmed for two axes, each with a separate preset, function, round off value, and near zero flashing point. However, only axes which are to be machined with the same tool can be used in the same step.

Preset - A preset is a machined dimension from the work print (drawing) that is programmed into memory. In a program, presets operate the same as in the DRO modes 1 and 2. In a step, however, a preset may refer to the previous step (i.e. current tool position) or to any previous step in the program.

Function - Function refers to the ABS, INCR, and REF function keys. These keys represent the type of move the preset value represents.

ABS refers to an absolute preset which moves workpiece zero. Absolute presets can be made in a program, but usually it is not advised because of the loss of the original workpiece zero.

INCR is an incremental move which represents the distance from the present location to the next desired point.

REF is a reference move which is the distance from the end point of the reference step indicated, to the next desired point. If REF function is used, the step # of the referenced point must be indicated. A reference step to workpiece zero is indicated as REF 0.

Round Off - The round off value is the resolution displayed for this step. The displayed resolution, however, should never be finer than the encoder resolution. A round off value is defined for each axis in the step.

Flashing - Flashing indicates the near zero value. This value sets the boundaries for the near zero display indicator (see page 43). Each axis is assigned a value.

Auto Step - Auto step links the next step with the current step. This makes it possible to display four axes of motion on the screen simultaneously. When auto step is active, the linked second step overwrites all previous information from the first step, except for different axes and display variables (preset, function, round off, flash). It is important that the linked steps use the same tool number, speed, and feed rates. Be careful that the same axis is not programmed in both steps, because the second programmed preset will overwrite the first preset.

Speed - This information is used as a "reminder" for the operator. The machine speed in RPM is displayed while running a program.

Feed - This information is also used as a "reminder" for the operator. Feed rate units are indicated in mm/rev or in/rev. The units can be toggled by pressing the INCH/MM key.

Tool Number - This is used to reference the tool numbers as programmed in the Tool Offset Table (see page 52). The display will be modified by the tool offset values. It is important that the two axes indicated in this step are either using the same tool or different tools with the **same** offsets, and the axes being programmed must be those for which tool offsets were entered. When running a program, a tool change is indicated by the tool number flashing.

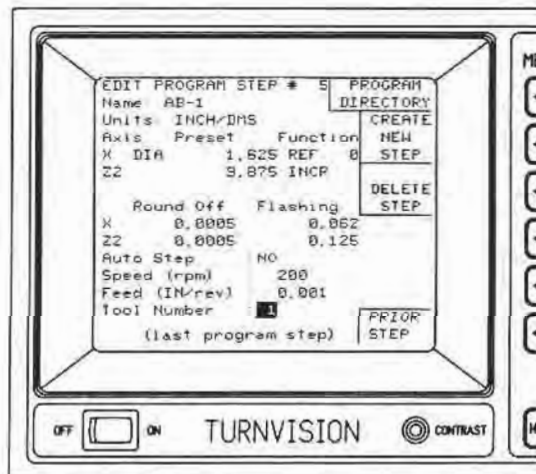

Figure 32. Program Step Information.

Creating a program

The following is a sequence to enter a program. To enter a program, proceed as follows:

- 1) From within the PROG mode, press the "CREATE PROGRAM NAME" menu key.
- 2) Select letters from the screen by moving the highlighted block with the arrow keys. When a chosen letter is highlighted, press the "ENTER LETTER" menu key. A name can also contain numbers (by pressing the numeric keys). If a character or number is entered incorrectly, press the "BACK SPACE" menu key to erase the last entry. A name can have up to 8 characters.
- 3) When the name is complete, press the "NAME DONE" menu key.

This will return the display back to the program directory screen. The new program name should be listed.

Note: the highlighted bar must be on the new program name to continue entering the program.

- 4) Press the "EDIT NAMED PROGRAM" menu key.
- 5) Enter the desired program multipliers (as explained on page 46). Multipliers have a default value of "1" unless changed.
- 6) Z coupling can combine Z1 + Z2, Z1 - Z2, or remain off (as explained on page 44). Press the desired menu key.
- 7) Press "CREATE NEW STEP" menu key.

This will display the first program step. Check the program name and the measurement units at the top of the screen. Units can be changed by pressing the INCH/MM and the DEG/DMS keys.

- 8) Indicate the axis using the axis keys.
- 9) Enter the axis preset required by using the numeric, decimal point, and sign keys.

Note: for angular encoders, all presets, round off, and flashing values can be entered in either DEG (decimal degrees) or DMS (degrees, minutes, seconds). To enter the DMS value, use a decimal point between each value.

- 10) Press the desired function key (REF, INCR, ABS). This will automatically move the highlight bar to that field.

If REF is chosen, it is necessary to enter the step number from which this move is referenced. A reference step to workpiece zero is indicated as REF 0. To enter the reference number press the new number.

Example: A target point (current step) is measured from a reference point (a previous step). The same step does *not* have to be referenced for all axes. The X-axis may reference one step number and the Y-axis may reference a different step number.

Entering a program (cont.)

- 11) Move the highlight bar to "Round Off". Set the desired resolution by pressing the "FINER" or "COARSER" menu key.
The display round off should not be set finer than the actual scale resolution.
- 12) Move the highlight bar to "Flashing" and indicate the near zero boundary desired for the first axis.
- 13) Repeat steps 8 through 11 for the second axis in this step.
- 14) Move the highlight bar to "Auto Step" and press the "YES" or "NO" menu key. If auto step is desired, the current step and the next step will be displayed at the same time with the second step parameters controlling the screen display.
- 15) Move the highlight bar to "Speed". Enter the reference machine speed desired for this step.
- 16) Move the highlight bar to "Feed". Enter the desired reference machine feed rate. This value can be indicated as in/rev or mm/rev. Toggle the display by pressing the inch/mm key.
- 17) Move the highlight bar to "Tool Number" and enter the desired tool number for the step. Only one tool number can be listed per step.

All other program steps follow the same input procedure. To continue with the next step in the program, press the "CREATE NEW STEP" menu key. This will display a screen representing the information required in the next step. **The information entered from the last step remains on the screen. The only area that is different is the "STEP #" at the top of the screen.** This allows the operator to change only the areas which need different values. **Note: "Auto Step" will always reset so it will not be carried accidentally from step to step.**

"DELETE STEP" and "PRIOR STEP" menu keys are active while inputting a program and can be used to make changes as required.

"DELETE STEP" deletes the step currently visible.

"CREATE NEW STEP" creates a step *after* the step currently visible.

When the last step of the program has been entered, press the "PROGRAM DIRECTORY" menu key. The program is entered and ready to be used in the DRO mode.

To view a program, proceed as follows:

- 1) Enter the PROG mode.
- 2) Highlight the program to be viewed.
- 3) Press the "VIEW OR PRINT PROGRAM" menu key.
Note: No changes can be made while in the "VIEW PROGRAM" routine.
- 4) Review the program by using the NEXT STEP key or the "PRIOR STEP" menu key.

Viewing a program

TURNVISION™

- 5) To jump to a specific step, press the STEP # key and desired number (numeric keys).
- 6) To exit the "VIEW PROGRAM" routine, press the "PROGRAM DIRECTORY" menu key.

Editing a program

To edit a program, proceed as follows:

- 1) Enter the PROG mode.
- 2) Highlight the program to be edited.
- 3) Press the "EDIT NAMED PROGRAM" menu key.
- 4) Make changes, as necessary, with the CLEAR, numeric, and menu keys. Move through the steps with the "NEXT STEP" and "PRIOR STEP" menu keys.
- 5) To jump to a specific step, press the STEP # key and the desired number (numeric keys).
- 6) When all changes are made, exit the program by pressing the "PROGRAM DIRECTORY" menu key.

Deleting a program

To delete a program, proceed as follows:

- 1) Enter the PROG mode.
- 2) Highlight the program to be deleted.
- 3) Press the "DELETE PROGRAM" menu key.
- 4) Verify the program to be deleted.
- 5) Press the "YES" menu key. The display will return to the PROGRAM DIRECTORY.

"NO" will abort the delete routine and return the display to the PROGRAM DIRECTORY.

RUNning a Program

Programs are executed from the PROG mode. The PROG screen display is the same format as in the DRO mode, page 40.

To run a program, proceed as follows:

- 1) Press the PROG mode and highlight the desired program.
- 2) Press the "RUN OR LEARN PROGRAM" menu key.
- 3) Highlight the word "RUN" (menu key).
- 4) Begin the program by pressing the NEXT STEP key.
While executing a program, the programmed presets may be temporarily changed by making "real-time" presets. These presets allow the operator to "override" the programmed presets for the current machining operation, without changing the actual program. Presets manually entered while in the PROG mode are completed in the same manner as other DRO mode presets.

The STEP # key can be used to "jump" to any step in the program. When a jump is performed, the entire program is recalculated, up to and including, the destination step.

Other keys active during a program operation are the INCH/MM, DEG/DMS and the RAD/DIA keys. These units can be toggled at any time by pressing the corresponding key. By changing the INCH/MM display, the feed rate will also change.

- 5) Work through the program, always machining to zero. When the operator reaches the last step of the program, the step number will flash. The program can be run again by pressing the NEXT STEP key.

The LEARN routine is a unique feature of TURNVISION which allows the operator to create a program while machining. This feature can also be used to add new steps on to the end of an existing program.

LEARNING a program

- 1) Press the PROG mode key.

If the LEARN routine is used to create a new program, a name must first be assigned in the PROGRAM DIRECTORY. Press the "CREATE PROGRAM NAME" menu key and enter the name.

If the LEARN routine is used to add steps to the end of an existing program, that program must be highlighted in the PROGRAM DIRECTORY.

- 2) Highlight the desired program name.
- 3) Press the "RUN OR LEARN PROGRAM" menu key.
- 4) Highlight the word "LEARN" by pressing the menu key.
- 5) To learn a program, the operator machines a part using presets to set the displays. Each time a machining operation is completed, the NEXT STEP key should be pressed. TURNVISION automatically enters the distance between the cutting surface's current position and the workpiece zero location for each axis (for all the axes that have moved). The values are used to create program reference presets for each step. The presets are entered into the program step as reference presets (referenced from the absolute zero of each axis). At the same time the presets are entered into memory, the current tool number is also entered, with the current measurement units. **Only axes that have moved will be used to create a new step.**

Note: If the operator wishes to display axes which are not part of the current step, the axis must be moved and then returned so TURNVISION records a movement made with that axis. If more than two axes have changed since the last step entry, the first two axes which showed movement will be used to create the next program step. The remainder of axes indicating movement within that display will be used to create a subsequent step. This activates the Auto Step feature (see page 62) to link the two steps. The same tool number will be used for both steps.

TURNVISION™

LEARNing a program (cont.)

Once the NEXT STEP key has been pressed, the operator is ready to begin the next machining operation. Continue this process until the part is completely machined.

It is recommended that absolute presets and absolute zero resets not be used. These presets move workpiece zero which may cause improper execution of subsequent learned steps.

Exit the "LEARN" routine by selecting "RUN" or pressing a mode key. Once a program is learned in the "LEARN" routine, it can be run, viewed, edited, or deleted (see pages 64 - 65).

TURNVISION OPTIONS Table of contents

Option	Page
Introduction	OP2
Footswitch	OP3
Edge Finder	OP3
Standard Edge Find Routine	OP4
Workpiece Positioning Routine	OP5
Two Point Calculation Routine	OP7
Centronics Parallel Communications	OP7
Program Printing	OP10
External Video Monitor	OP10
RS-232 Communications	OP11
Protocols	OP11
Printer Function	OP14
SAVE	OP16
LOAD	OP17
DELETE	OP17
Computer Communication	OP18
Data Requests	OP19
Keyboard Function	OP21
Appendices	OP23
Remote Storage Device File Format	OP23
Communication Commands	OP24
Connector Specifications	OP30

TURNVISION™

Introduction

Powerful capabilities are added, when your standard TURNVISION is upgraded with ACU-RITE's option module (part number 387800-4060):

Footswitch

TURNVISION's footswitch offers three "hands-free" functions — PRINT key, NEXT STEP key, PRINT and NEXT STEP keys.

Edge Finder

The edge find option offers three routines — standard edge locating, workpiece positioning, and two point calculations.

Centronics Parallel Communications

The parallel communications option gives the operator means of making hard copy documentation of positional or other screen information.

External Video Monitor

The video monitor option allows the operator to monitor all TURNVISION operations on an external CRT.

RS-232 Communications

TURNVISION's RS-232 option can be configured to support three functions — printer, program storage, and computer communications.

Be sure to refer to the "INSTALLATION" tab section, page 4, to correctly install the options module.

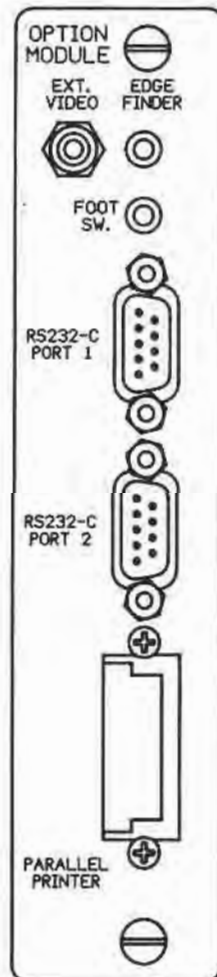

Figure OP1. Option Module.

Footswitch input

TURNVISION's footswitch option can perform three "hands-free" functions:

1. PRINT key
2. NEXT STEP key
3. PRINT and NEXT STEP key

The footswitch can function as the PRINT key for a hard copy of a formatted DRO or program screen with virtually every screen being able to be printed. The second function the footswitch option can perform is the NEXT STEP key for running or learning a program. The operator's hands never have to leave the machining operation. The footswitch can also function as both the PRINT and NEXT STEP keys. If "PRINT KEY AND NEXT STEP" is selected, the print function will be performed first.

Connect the footswitch cable to the "Foot Sw." input on the back of TURNVISION. To select the function, proceed as follows:

- 1) Press the  key.
- 2) Press the "OPTION-MODULE CONFIGURATION" menu key.
- 3) Press the "FOOTSWITCH FUNCTIONS" menu key.
- 4) Select the desired footswitch function.

The footswitch can now replace a key press for "hands free" actuation.

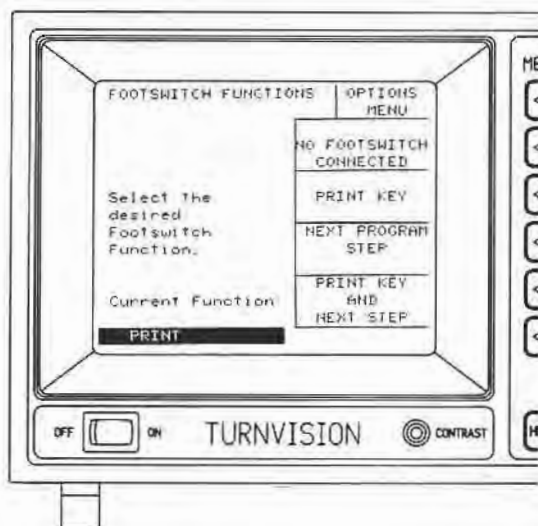

Figure OP2. Footswitch Configuration Screen.

Edge finder input

NOTE: TURNVISION's edge find capability is only possible using the option module (the connector on the CPU module is non-functional).

TURNVISION's edge finder option offers three functions:



1. Standard edge find
2. Workpiece positioning
3. Two point calculation

To calculate these functions, the ball radius and edge find axis offset are used as tool offsets and must be entered in the SET TOOL Mode. The edge finder offsets can be entered into TURNVISION manually or through the automatic edge finder offsets routine.

TURNVISION™

Manual entry of edge finder offsets

To enter edge finder offsets manually, proceed as follows:

- 1) Press the  key.
- 2) Press the "Edit Edge Finder Offsets" menu key.
- 3) Enter the ball diameter. This value can be inches or millimeters and can be changed instantly by pressing the INCH/MM key.
- 4) Enter the edge finder axis offset values. Offset values are measured from the center of the ball.
- 5) Press the  key to return to the DRO mode.

Automatic edge finder offsets

The automatic edge finder offsets routine determines offsets from reference measurements.

To enter offsets through the automatic routine, proceed as follows:

- 1) Press the  key.
- 2) Press the "Automatic Edge Finder Offsets" menu key.
- 3) With the numeric keys, enter the edge finder ball diameter.
- 4) Move the edge finder until it touches a reference surface.
- 5) Select the axis to offset.
- 6) Back the edge finder away from the reference surface and measure the position with a micrometer. Enter the position with the numeric keys. TURNVISION determines which direction the center of the edge finder is located when the edge is touched.

Note: The edge finder must be removed (backed away) from the reference surface between consecutive axis selections. This prevents the operator from erroneously touching in a "corner" and offsetting two axes at once. If the edge finder has not been removed, the following message will appear: "Edge Finder has not touched!"

- 7) Press the "Measurement Complete" menu key.

Once the edge finder information is entered in the SET TOOL Mode, any of the three edge find routines can be used.

The standard edge find function freezes the absolute display when the edge finder touches the workpiece.

Follow the steps below to use the standard edge find function while in the DRO Mode:

- 1) Press the  key.
- 2) Press the desired axis key. The edge find option can only be used on one axis at a time. The other axes maintain normal counting functions and are unaffected by the edge find routine.

Standard edge find function

- 3) Touch the edge finder to the desired point and the absolute display will freeze. The edge find axis will indicate "EF FROZEN". The incremental display will be zeroed at the edge find touch, but will continue to count showing how far the edge finder continues to move.

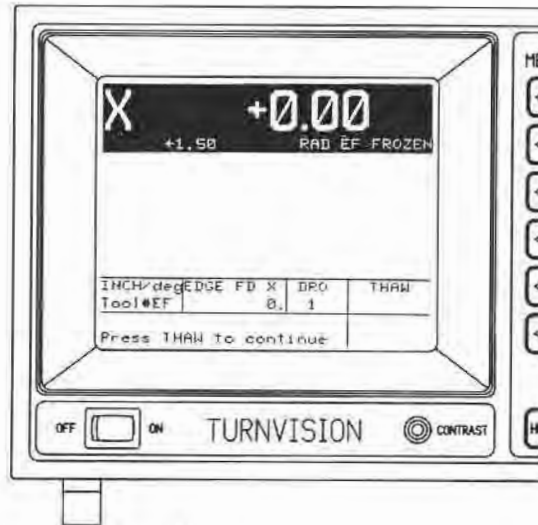



Figure OP3. Standard Edge Find Function Screen.

- 4) Press the "THAW" menu key to complete the operation. Once the axis is thawed and the edge find operation is complete, the display will return to normal DRO operations.

Edge find — workpiece positioning

The workpiece positioning function sets the workpiece zero to the point at which the edge finder touches the workpiece. This is an easy way to set the edge of the part as workpiece zero.

Follow the steps below to use the workpiece positioning function while in the DRO mode:

- 1) Press the  key.
- 2) Press the desired axis key. The edge find option can only be used on one axis at a time. The other axes maintain normal counting functions and are unaffected by the edge find routine.
- 3) Press the "Work. Position" (workpiece position) menu key.

TURNVISION™

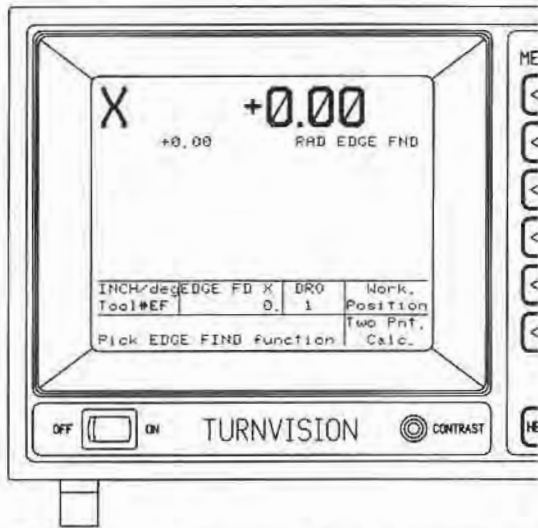

Figure OP4. Workpiece Positioning Edge Find Function Screen 1.

- 4) Move the edge finder to touch the edge of the workpiece. When the part is touched, the display is zeroed and frozen while taking into consideration the radius of the edge finder.
- 5) Verify the point by pressing the "VERIFY POINT". If the wrong point was touched, press the "TRY AGAIN" menu key and touch the part.

Once the point is verified, the edge find routine is complete and the display will return to normal DRO operations.

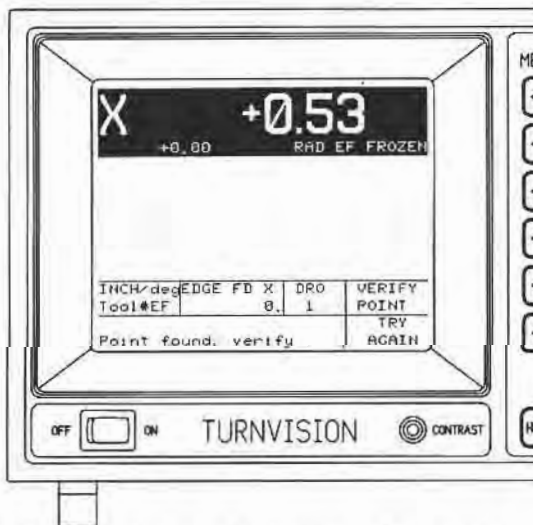



Figure OP5. Workpiece Positioning Function Screen 2.

Two point calculation

The two point calculation function computes the distance and center location between two consecutive edge findings.

Follow the steps below to use the two point calculation function while in the DRO mode:

- 1) Press the  key.
- 2) Press the desired axis key. The edge find option can only be used on one axis at a time. The other axes maintain normal counting functions and are unaffected by the edge find routine.
- 3) Press the "Two Pnt. Calc." menu key.
- 4) Touch the edge finder to the first point on the workpiece. Press the "VERIFY POINT" menu key to confirm the point, or press the "TRY AGAIN" menu key to touch the workpiece again.
- 5) Touch the second point on the workpiece. The axis display is now frozen. Confirm the point by pressing the "VERIFY POINT" menu key.

The DRO message area now displays the distance and center point between the two points.

- 6) Press the "LOCATE CENTER" or "ZERO CENTER" menu key.

If "LOCATE CENTER" is selected, a reference preset of the center value is performed. This allows the operator to locate the center position by moving the incremental position until it reads zero.

If "ZERO CENTER" is selected, the workpiece zero position is set to the center position.

Note: The edge find routine can be cancelled by pressing the EDGE FIND key. Any preset, tool selection, multiple scale coupling, etc. will also cancel the edge find routine.

Centronics parallel communications output

The parallel communications output option gives the operator means of making hard copy documentation of positional or other screen information. ACU-RITE part number 388000-103 is a compact 110 VAC parallel printer ideal for use with this option. With the proper printer connections, the Print key will give a formatted print of any display screen. The only screen information that will not print, is the menu key information.

Connection





Communication to a parallel printer is via the parallel printer port on the back of TURNVISION. A male 16 pin SDL connector, with a centronics compatible pinout is required for proper connections.

TURNVISION™

Pin-out definition:

pin 1 - strobe (active low)	(out)
2 - data 1	(out)
3 - data 2	(out)
4 - data 3	(out)
5 - data 4	(out)
6 - data 5	(out)
7 - data 6	(out)
8 - data 7	(out)
9 - data 8	(out)
10 - acknowledge (active low)	(in)
11 - busy	(in)
12 - paper empty	(in)
13 - select	(in)
14 - auto feed	(out)
15 - N.C.	
16 - GND	

After proper connections have been made, the parallel printer option is activated and configured as follows:

- 1) Press the  key.
- 2) Press the "OPTION-MODULE CONFIGURATION" menu key.
- 3) Press the "PARALLEL PORT FUNCTIONS" menu key.
- 4) A highlight bar will be on the first field. To activate the printer, make sure the "Parallel Status" indicates "On" by pressing the "On" menu key.
- 5) Press the  key to move the highlight bar to the next parameter. The "Output Tail" is the desired number of blank lines that will follow the end of each printout. Enter the desired number of lines by pressing the corresponding number key (0-9).
- 6) Press the  key to move the highlight bar to the next parameter. "LF after CR" can be selected as "Yes" if the connected printer requires a line feed after a carriage return. If a line feed is not needed, select "No" by pressing the corresponding menu key.
- 7) Press the  key to move the highlight bar to the last parameter, "Printer Size". If the connected printer width is less than 40 columns wide, press the "Less than 40 columns" menu key. If the connected printer width is more than 40 columns wide, press the "40 columns or more" menu key.

Parameters are now set for the parallel printer option and need not be set again, unless changes are desired. Press the "Options Menu" menu key or a mode key to exit the screen.

Setting printer parameters

A formatted print out will be similar to the following:

TOOL# 2			
X	INC	+2.971	IN DIA
	ABS	+2.971	IN DIA
Z1	INC	+0.0435	IN
	ABS	+0.3685	IN

Figure OP6. DRO Printout.

PROGRAM DIRECTORY	
PROGRAM NAME	STEPS IN USE
AB1	3
AB2	4
4444	4

STEPS AVAILABLE 189

Figure OP7. Program Mode Printout.

If the PRINT key is pressed when the printer is busy, not accepting characters, or not connected, the following screen will appear:

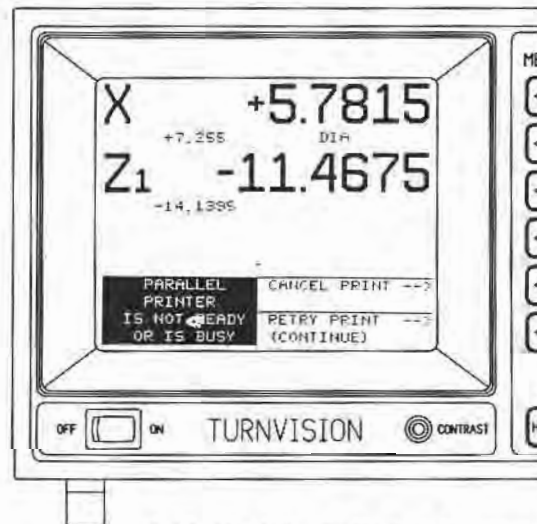

Figure OP8. "Printer is Busy" Screen.

Two menu options are available. The operator can cancel the print function or retry the print function.

TURNVISION™

Program printing

There are two ways to print program steps; a short form and a long form. The short form prints out a short version of the entire program (see Figure OP9 below). The long form prints out a detailed version of each desired step number (see Figure OP10 below).

For program mode print outs, proceed as follows:

- 1) Press the **PROG** mode key.
- 2) Press the "VIEW or PRINT PROGRAM" menu key.
- 3) Press the desired print form — short or long.

```
PROGRAM NAME: AB2
MULTIPLIERS: X =      1.
              Z1 =     1.
              Z2 =     1.
              Y =      1.

      Z Coupling: Z1+Z2
STATUS: INCH RAD DEG

-----
STEP AXIS  PRESET  FUNCTION TOOL
-----
  1  X      0. REF  0  1
     Z1     0. REF  0
  2  X  0.499803 REF  0  1
     Z1    -2. REF  0
  3  X  0.250394 REF  0  1
     Z1 -1.250394 REF  0
  4  X  0.014764 REF  0  2
     Z1    -2. REF  0

      END OF PROGRAM
```

Figure OP9. Short Printout.

```
VIEW PROGRAM STEP # 1
Name: AB2
Units: INCH/des
Axis  Preset  Function
X      0. REF  0
Z1     0. REF  0

      Round Off  Flashing
X      0.0001      0.
Z1     0.0005      0.
Auto Step :NO
Speed (rpm) : 0.
Feed (IN/rev) : 0.
Tool Number : 1

-----
```

Figure OP10. Long Printout.

External Video Monitor

The video monitor option allows the operator to monitor all TURNVISION operations on an external CRT. No parameters need to be set, just plug the female phone plug into the "EXT. VIDEO" port on the back of TURNVISION.

TURNVISION™

RS232 Communications

TURNVISION's external interface is compatible with NTSC (National Television System Committee) composite input monochrome monitors. It is recommended that all monitors to be used with the option module, be equipped with external horizontal width and vertical size controls.

The TURNVISION Option Module is equipped with two RS232 ports. These ports can be configured to support any of the following three functions:

1. Printer Port
2. Program Storage
3. Computer Communications

Connection

Communication to support any of these functions is via one of the RS232-C ports on the back of TURNVISION. A female 9 pin, D-subminiature connector cable is required for proper connections.

Serial Port Pin Assignments

Pin	I/O	Description
2	I	Incoming Data
3	O	Out going data
4	O	When active (logic "0", +12V), it informs the other device that TURNVISION is available to communicate.
5		Signal ground
6	I	When active logic "0", +12V), it indicates that the other device is available to communicate.
7	O	When active (logical "0", +12V), it indicates that TURNVISION is ready to receive data.
8	I	When active (logical "0", +12V), it indicates the device is available to receive data.

Setting protocols

Protocols are needed to configure the port to communicate properly with the printer, computer or remote storage device connected. Protocols define the handshaking and the way data is exchanged between TURNVISION and the external device. To set these protocols, follow the procedure below:

- 1) Press the SET SYS key and then the "OPTION-MODULE CONFIGURATION" menu key.
- 2) Press the "RS-232 PROTOCOLS" menu key.
- 3) Press the desired port — "Port 1" or "Port 2".

TURNVISION™

- 4) Use the arrow keys to move through the protocols and make the appropriate choice for each handshaking field. An explanation of each protocol is described below. To exit the "RS-232 PROTOCOLS" screen, press a mode key.

Baud Rate

Baud rate is the speed at which information will travel over the communication link. Although TURNVISION allows very fast baud rates (up to 19,200 bits/second) there is a point which the system throughput will no longer increase with faster baud rates — faster is not always better.

TURNVISION can process information at a relatively fixed rate. If TURNVISION cannot process the information as fast as it is coming in, one of two things will occur:

1. If no handshaking is used, input buffer overflow will occur, and TURNVISION will produce a System Error.
2. If handshaking is used, TURNVISION will "tell" the other device to stop sending data until it can catch up.

For most applications, TURNVISION's optimum baud rate is 1,200 bits/second. Speeds higher than this will *not* significantly improve performance. The chosen baud rate must be the same as the device interfaced.

Parity

Parity is a form of error checking on the received data. When data is transmitted, an additional bit of information is attached. This bit is checked at the receiver, and if it is incorrect, an error condition is flagged. TURNVISION can be configured for three of the most common forms of parity (even, odd, or none). The chosen type of parity must be the same as the device interfaced.

Data bits

Since ASCII information is being transferred, only seven data bits are required. Some devices, however, require eight data bits. Therefore, TURNVISION is configurable for either. The chosen number of data bits must be the same as the device interfaced.

Stop bits

Stop bits signify the end of a piece of data. Only one is required, with TURNVISION, unless the interfaced device requires two. Both devices must be configured for the same number of stop bits.

XON/XOFF

XON/XOFF is a form of software handshaking. Handshaking is a method of controlling the flow of information so the receiving device will be ready for incoming information when it arrives. If the receiving device is not ready, it must tell the transmitting device not send anything for a while. This is accomplished with the XON/XOFF protocol. If a device is not ready to receive, it sends an XOFF character to tell the other device not to send any data. When it is ready to process more information, it sends an XON character to tell the other device "it is ok to send now".

If this protocol is enabled, *both* devices must be capable of transmitting and responding to the XON/XOFF characters.

Hardware Handshaking Signals

Pins 4, 6, 7, and 8 on each serial port are hardware handshaking signal lines. Hardware handshaking performs the same task as software handshaking, but in a different manner.

The signals on pins 4 and 6 are handshake signals that allow each device to tell the other device it is available for communications. Pin 4 is an output for TURNVISION that, when active (logical "0", +12V), signals the remote device that TURNVISION is available for communication. The signal on pin 6 is an input to TURNVISION that, when active (logical "0", +12V), indicates to TURNVISION that a remote device is connected to the other end of the serial cable and that the remote device is ready to communicate.

Note: TURNVISION requires an active (logical "0", +12V), signal on pin 6 to enable it to communicate with another device. If the attached device does not provide such a signal, it will be necessary to wire pin 4 to pin 6 on the TURNVISION end of the serial cable. This jumper will provide the necessary signal on pin 6 to allow communications.

The signal on pin 7 is an output from TURNVISION that can be described as "ready to receive". When this output is active (logical "0", +12V), it signifies that TURNVISION is ready for incoming information. When TURNVISION cannot accept more data, it sets this output inactive (logical "1", -12V).

The signal on pin 8 is an input to TURNVISION. When the signal is active (logical "0", +12V), TURNVISION knows that it can send data. When the signal is inactive (logical "1", -12V), it tells TURNVISION to "shut up". The handshake signal is ignored if "CTS" is designated as inactive in the protocols for that port in "SET SYS", "RS-232 PROTOCOLS".

Hardware vs software handshaking

Both types of handshaking address the same problem: regulation of data flow. Using both hardware and software handshaking is redundant, but the system will work with both (assuming the other device supports both methods). At low baud rates, handshaking may not be required at all. At higher baud rates, the system will fail unless some form of handshaking is used.

The form of handshaking the operator chooses, depends on the device interfaced. Some devices are only capable of one form of handshaking, either hardware or software. TURNVISION's option module was designed for flexibility, allowing either form of handshaking. TURNVISION must be configured to the same form of handshaking as the device interfaced. If the interfaced device does not support either form of handshaking, slower baud rates must be used.

Pin outs

The following pin outs are examples of interfacing PCs with a 9-pin and a 25-pin connector.

TURNVISION™

TURNVISION Interfaced to a 25-pin Computer (IBM-PC):

TURNVISION pin # Name	direction	Computer pin # Name
2 RxD (Receive Data)	<-----	2 TxD (Transmit Data)
3 TxD (Transmit Data)	----->	3 RxD (Receive Data)
4	----->	6
6 Handshake Lines	<-----	20 Handshake Lines
7 See page OP13	----->	5
8	<-----	4
5 signal ground	-----	7 signal ground



TURNVISION interfaced to a 9-pin Computer (IBM PC-AT):

TURNVISION pin # Name	direction	Computer pin # Name
2 RxD (Receive Data)	<-----	3 TxD (Transmit Data)
3 TxD (Transmit Data)	----->	2 RxD (Receive Data)
4	----->	6
6 Handshake Lines	<-----	4 Handshake Lines
7 See page OP13	----->	8
8	<-----	7
5 signal ground	-----	5 signal ground

The RS232 printer function gives the operator means of making hard copy documentation of positional or other screen information.



By configuring one of the RS232 ports for the print function, the Print key will perform a formatted print of any display screen. The only screen information that will not print, is the menu key information.

After proper connections have been made, protocols and parameters regarding the printer must be defined in the SET SYS mode. To set protocols refer to page OP11. To set parameters proceed as follows:

- 1) Press the  key.
- 2) Press the "OPTION-MODULE CONFIGURATION" menu key.
- 3) Press the "RS-232 FUNCTIONS" menu key.
- 4) Press the desired RS-232 port — "Port 1" or "Port 2" menu key.
- 5) For the "Port Function" field, press the "Printer" menu key.
- 6) Press the  key to move the highlight bar to the next parameter. The "Output Tail" is the desired number of blank lines that will follow the end of each printout. Enter the desired number of lines by pressing the corresponding number key (0-9).

Printer port function

Setting printer parameters

- 7) Press the  key to move the highlight bar to the next parameter. "LF after CR" can be selected as "Yes" if the connected printer requires a line feed after a carriage return. If a line feed is not needed, select "No" by pressing the corresponding menu key.
- 8) Press the  key to move the highlight bar to the last parameter, "Printer Size". If the connected printer width is less than 40 columns wide, press the "Less than 40 columns" menu key. If the connected printer width is more than 40 columns wide, press the "40 columns or more" menu key.

Parameters are now set for the printer function and need not be set again, unless changes are desired.

The program storage interface allows the operator to save to, load from, and delete programs on a vision remote storage device. This remote storage device can be any device which supports the protocols for program storage. The appendices for this section of the manual contains the required file format and command information needed to write a program for a computer or other storage device to allow it to act as a remote storage device for TURNVISION. TURNVISION programs are stored in MSDOS format to allow for easy manipulation, duplication and deletion. A program which configures an IBM, IBM-AT or an IBM compatible to provide storage transfer capability is available on floppy disk from ACU-RITE (1-800-344-2311).

After proper connections have been made, protocols and parameters regarding the chosen remote storage device must be defined in the SET SYS mode. To set protocols, refer to page OP11. To set parameters proceed as follows:

- 1) Press the  key.
- 2) Press the "OPTION-MODULE CONFIGURATION" menu key.
- 3) Press the "RS-232 FUNCTIONS" menu key.
- 4) Press the desired RS-232 port — "Port 1" or "Port 2" menu key.
- 5) For the "Port Function" field, press the "External Storage" menu key.
- 6) The next three parameters, "Output Tail", "LF after CR", and "Printer Size" fields only pertain to the printer function and are ignored when the external storage function is selected. Parameters are set and this screen can be exited by pressing a mode key or by pressing the "Port Select Menu".

During program transfers between, TURNVISION and a vision remote storage device, TURNVISION is always the **issuer** of commands and the remote storage device is always the **respondent**. Three program transfer functions are available and are performed in the program mode:

Program storage function

Setting remote storage device parameters

Program transfers

TURNVISION™

SAVE - allows the transfer of a program from within TURNVISION to a remote storage device.

LOAD - allows a program stored in the remote storage device to be loaded back into TURNVISION for use.

DELETE - allows a program in the remote storage device to be deleted.

To SAVE, LOAD, or DELETE a program, proceed as follows:

- 1) Press the **PROG** key to enter the "Program Directory".
- 2) Move the highlight bar to the program to be transferred.
- 3) Press the "PROGRAM TRANSFERS" menu key.
- 4) Select the RS232 port to be used. Only ports which have been configured will be listed as available. If only one RS232 port is available, TURNVISION knows which port has been configured, and this step is skipped.
- 5) Select the function to be performed. A confirmation message should appear, indicating the transfer was successful.

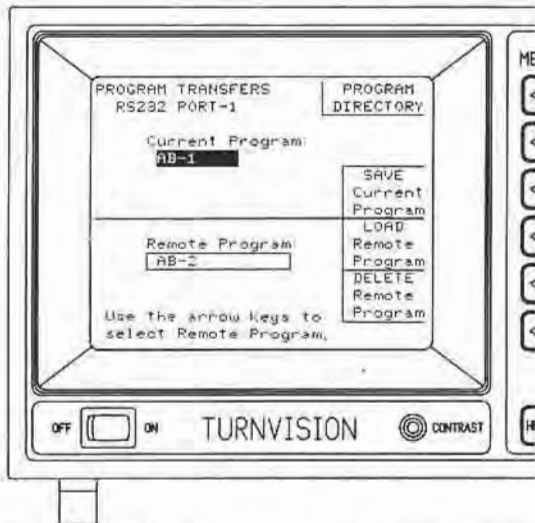

Figure OP11. Program Transfers Screen.

The "SAVE" function requires that there be a program created in TURNVISION, and that the remote storage device has enough storage to hold the program. After a "SAVE" command, the file is displayed in the "Remote Program" window. Programs saved on the remote storage device are stored alphanumerically.

The remote storage device can support a maximum of 25 programs per disk directory. This limitation makes finding a program easier and reduces the risk of saving a program to a full disk.

Program transfer SAVE

TURNVISION will not save to a remote storage device if the disk is full. A message will appear warning the operator that there is insufficient storage. The "SAVE" function can be cancelled, by pressing the "CANCEL" menu key. If TURNVISION is in the middle of the function, however, the "CANCEL" key must be pressed for a few seconds to cancel the transfer.

To help the operator maintain revision control of a program, the remote storage device automatically provides a revision level which is placed in the filename extension. The first time a program is saved on a particular diskette or subdirectory in the remote storage device, the program name will have a suffix of ".000". This revision level increases each time the program is saved — it will not overwrite an existing program. The revision level does not become part of the program filename; rather, is used as a visual aid to keep track of various program generations. Any program revision may be deleted. The revision level will not revert to ".000" unless every copy of the program has been removed.

Program transfer LOAD

Only the program currently displayed in the "Remote Program" window can be loaded from the remote storage device. A program is located by scrolling through the remote storage device directory with the up and down arrow keys. The "Remote Program" window cannot be scrolled past the last program in the Remote Storage directory. TURNVISION automatically calculates available memory in the program directory and loads the program *only* if there is enough memory. If there is not enough memory to hold the program, the "LOAD PROGRAM" menu key is removed from the display and the following message is displayed:

"Insufficient TURNVISION Memory to Load Program".

If the LOAD operation is CANCELLED, none of the program will be transferred. TURNVISION and the Remote Storage Device will not transfer a partial program.

After a program is loaded successfully, a confirmation message appears on the screen. This message remains until the operator exits the screen or another program function is selected.

Note: Only programs which are compatible with TURNVISION software can be loaded.

Only the program currently displayed in the "Remote Program" window can be deleted from the remote storage device program directory. If a program is deleted, the next program in the directory is displayed in the "Remote Program" window.

When the "DELETE PROGRAM" function is selected, TURNVISION asks the operator to confirm the command. The "YES" menu key *must* be selected for the program to be deleted. Any other keypress will terminate the operation.

If a transfer was not successful, one of the following messages may appear:

"Insufficient TURNVISION Memory to Load Program" - This message indicates that TURNVISION's program directory is full, but programs *can* be SAVED to or DELETED from the remote storage device.

Program transfer DELETE

Program transfer errors

TURNVISION™

“Insufficient External Storage to save Program” - This message indicates the Remote Storage Device directory or disk is full, but programs *can* be LOADED or DELETED from the remote storage device.

“The External Storage does not respond” - This message indicates that there is *no* communication between TURNVISION and the remote storage device. Check to ensure proper connections have been made.

“Program not LOADED - invalid program” - This message indicates that an incompatible program was attempted to be loaded. Only programs which are compatible with TURNVISION software can be loaded.

Each data transfer is “guarded” by a checksum technique to ensure data has been properly transferred. Data communication errors may, however, occur. The following are possible errors:

ERROR: Remote Storage Device fails to respond.

ERROR: Disk read error.

ERROR: Program NOT SAVED - Disk write protected.

ERROR: Program not SAVED - communication error.
(also triggered by a cancelled “SAVE”)

ERROR: Program Not Found.

ERROR: Program not LOADED - communication error.

ERROR: Program not LOADED - invalid program.

If an error occurs, TURNVISION will not retry the transfer. The operator is instructed on how to first, fix the problem, and then repeat the operation. An error message is displayed until the operator exits or repeats the transfer.

TURNVISION can respond to remote simulated keypresses from a computer and to a variety of commands through the RS-232 ports. Both RS-232 ports are identical in operation, and yet, completely independent of each other.

The RS232 computer function offers two options: data requests and a remote keyboard. The data request function allows the operator to request such information as tool position, axis positions, and TURNVISION’s current mode. The keyboard function allows a computer to simulate TURNVISION’s keyboard.



Setting computer parameters

After proper connections have been made via one of the two RS232 ports on the back of TURNVISION, parameters protocols regarding the chosen computer must be defined in the SET SYS mode. Refer to page OP11 to set protocols. To set parameters proceed as follows:

- 1) Press the  key.
- 2) Press the “OPTION-MODULE CONFIGURATION” menu key.

RS232 computer communication

Data request function

- 3) Press the "RS-232 FUNCTIONS" menu key.
- 4) Press the desired RS-232 port — "Port 1" or "Port 2" menu key.
- 5) For the "Port Function" field, press the "Computer" menu key.
- 6) Press the  key to move the highlight bar to the next parameter. The "Output Tail" field only pertains to a printer function and is ignored when the computer function or the external storage function is selected.
- 7) Press the  key to move the highlight bar to the next parameter. The "LF after CR" (line feed after carriage return) field can be selected ("YES") if the connected computer requires a line feed after a carriage return. If the line feed is not needed, select "NO" by pressing the corresponding menu key.
- 8) Press the  key to move the highlight bar to the next parameter. The "Printer Size" field only pertains to a printer function and is ignored when the computer function or the external storage function is selected.

The data request option allows an external serial device to poll TURNVISION for process control and SPC data. The following items can be requested:

- Reset Channel
- Keyboard Echo
- Full Screen Prints
- Incremental Axis Position
- Absolute Axis Position
- Inch/MM Status
- RAD/DIA Status
- Axis Position
- Current Tool Number
- Current Readout Mode
- Filter Status

Each data request to TURNVISION is terminated by a carriage return. This carriage return marks the "end of transmission" and informs the readout to execute the request. In the same manner, after TURNVISION responds to a request, it marks the end of a transmission with a carriage return.

Invalid data requests or invalid character sequences automatically close communications until a reset command is issued. This prevents an invalid request from causing damage to TURNVISION.

All data requests begin with a question mark ("?") and then one to two additional characters. The following is a list and definition of available requests:

Note: For each request, enter the information *within* the quotes — do not enter the quotes. Commands and responses are followed by a carriage return (<cr>), which signifies the end of a transmission.

An echo string table can be found on page OP22.

TURNVISION™

Reset Channel ("?* <cr>") - The reset channel request cancels any previous or pending requests and re-initializes the communication buffers.

Keyboard Echo ("? = <cr>") - This request turns on/off the echo mode. Within the echo mode, there are three formats:

echo mode 0: no echo

echo mode 1: echo the exact character (refer to key table on page OP22 for character code)

echo mode 2: echo a descriptive string (refer to key table on page OP22 for string definition)

This feature is necessary for terminals which require a keyboard echo from the host device. The data requests and storage commands, themselves, will not echo. To change the echo mode use the following commands:

Mode	Command
echo mode 0:	"?E0 <cr>"
echo mode 1:	"?E1 <cr>"
echo mode 2:	"?E2 <cr>"

Print Screen ("?P <cr>") - This request provides a character by character reproduction of all ASCII characters currently on the screen. This allows the computer to request full screen prints. Output format consists of 16, 32 character strings each terminated by a single carriage return character.

Incremental Position ("?Ix <cr>") Where X = 1, 2, 3 or 4 for axis X, Z1, Z2 and Y respectively. This data request provides each incremental axis position. Output is a 19 digit ASCII string of eight numeric digits, sign, decimal point (+1234.6789), measurement units and crossfeed format. Position requests are only valid when the readout is in the DRO Mode.

Example:

Command: ?I2 (incremental position for axis #2)
Response: Z1 = -1234.5678 DEG

Absolute Position ("?Ax <cr>") Where X = 1, 2, 3 or 4 for axis X, Z1, Z2 and Y respectively. This data request provides each absolute axis position. Output is a 19 digit ASCII string of eight numeric digits, sign, decimal point (+1234.6789), measurement units and crossfeed format. Position requests are only valid when the readout is in the DRO mode.

Example:

Command: ?A1 (absolute position for axis #1)
Response: X = +1234.5678 IN DIA

Note: Unavailable axes or positions requested outside of the DRO mode will produce the following response:

** = ***** ** **

Inch/mm Status ("?U <cr>") - The linear units response is "IN" for inch and "MM" for millimeters, followed by a carriage return.

TURNVISION™

RAD/DIA Status ("?C<cr>") - This status is indicated as "R" for radius and "D" for diameter units.

DEG/DMS Status ("?D<cr>") - This status is indicated as "D" for degrees and "G" for DMS.

Axis List ("?X<cr>") - This request allows the operator to determine displayed axes and their positions. The axes are listed according to their availability and numerical designation. The numerical designations of one through four are X, Z1, Z2, and Y. If an axis is missing, it is represented by asterisks. For example, if X and Y were not available, the output would be "***Z1Z2***".

Current Tool ("?T<cr>") - This request provides the current tool number in use, 1-24.

Current Readout Mode ("?M<cr>") - This request determines which mode TURNVISION is in. Responses are as follows:

"H" = HELP
"D" = DRO
"P" = PROGRAM
"T" = SET TOOL
"C" = CALCULATOR
"S" = SET SYSTEM

Filter Status ("?F<cr>") - This request allows monitoring of the thermal and filter condition of TURNVISION. If the filter and thermal conditions are good, the response is "0". If the temperature is too high or the filter has been removed the response is "1".

Keyboard function

The keyboard function allows a computer to simulate TURNVISION's keypad. The TURNVISION keypad has been mapped to a standard ASCII terminal (Zenith Z-19).

The "keypress" mode must be entered to use the keyboard function. The keypress mode is entered by pressing the "%" character. The port will remain in the keypress mode until a carriage return (<cr>) is received. Invalid keypresses are acknowledged with an asterisk and bell characters ("* <ctrl>G").

Note: To terminate the keypress mode, enter a carriage return.

Each character received is interpreted as a simulated keypress. The character-to-key conversion table is on page OP22. TURNVISION provides an echo of the keypress if desired (see page OP22). Depending on the echo mode, TURNVISION can echo the received character, echo a more descriptive string, or echo nothing.

Note: The RS-232 keypress feature has an important restriction: The operator should not access the RS-232 configuration screens (Set System) by using the remote keyboard. Access to these menus will have adverse affects on the port, regardless of whether any values were actually changed.

TURNVISION™

The character code definitions are as follows:

TURNVISION Keys	ASCII Keyboard Character	Echo String
Menu keys:		
M1	A	(1)
M2	S	(2)
M3	D	(3)
M4	F	(4)
M5	G	(5)
M6	H	(6)
Axis keys		
X	Q	X
Z1	W	Z1
Z2	E	Z2
Y	R	Y
Digit keys:		
0	0	0
1	1	1
2	2	2
3	3	3
4	4	4
5	5	5
6	6	6
7	7	7
8	8	8
9	9	9
.	.	.
-	+/-	-
Preset keys:		
ZERO RESET	Y	ZERO RESET
CLEAR	T	CLEAR
EDGE FIND	J	EDGE FIND
PRINT	K	PRINT
AXIS CPLE	L	AXIS CPLE
STEP #	B	STEP #
NEXT STEP	N	NEXT STEP
TOOL #	M	TOOL #
Mode keys:		
HELP	!	HELP
DRO	@	DRO
PROG	#	PROG
SET TOOL	\$	SET TOOL
CALC	%	CALC
SET SYS	*	SET SYS
Function keys:		
REF	U	REF
INCR	I	INCR
ABS	O	ABS
INCH/MM	Z	INCH/MM
RAD/DIA	C	RAD/DIA
DEG/DMS	X	DEG/DMS

TURNVISION™

Arrow keys:

Up	[^
Down	/	v
Left	:	<-
Right	,	->

Options appendices

Remote storage device

This appendix contains file format and command information needed if an operator chooses to write a program to support program transfers.

Each file contains a "GENERAL IDENTIFICATION HEADER". The information format and required bytes of the header is as follows:

TURNVISION ID/	1 byte	"T"
VERSION NUMBER	1 byte	"8"
MODE ID (PROG MODE)	1 byte	"P"
File Type (within mode)	1 byte	"O"
USER SPACE (general use)	(75) bytes	
end of record/line	1 byte	(<cr>)
TOTAL		80 bytes

NOTE:

All "real" numeric entries are to consist of a right justified ASCII signed string, with leading zeros suppressed to spaces. The sign is to be located at the immediate left of the most significant digit; the positive sign suppressed to spaces. For example: "0.012345", "-12.3442", "58.844023", "-7.". In addition, all presets and flashing points are to be described in "mm" or "degree" units only.

All integer values are right justified ASCII unsigned strings, with leading zeros suppressed, except in the units position. For example: "12", "0", "154".

The "USER SPACE" is located in the "GENERAL IDENTIFICATION HEADER" and is formatted as follows:

Program Name	8 bytes character string	
Number of Steps (last step #)	3 bytes integer	
Axis X Multiplier	10 bytes real	
Axis Z1 Multiplier	10 bytes real	
Axis Z2 Multiplier	10 bytes real	
Axis Y Multiplier	10 bytes real	
Reserved info.	7 bytes	
Z-Coupling flag		
0 = off, 1 = add, 2 = subtract	1 byte	
Reserved info.	16 bytes	
TOTAL		75 bytes

"PROGRAM STEP RECORD:" (0-999 per program)
Each record consists of continuous data followed by a <cr> (carriage return).

Axis 1 Name 0 = null, 1 = x, 2 = z1, 3 = z2, 4 = y	1 byte
Axis 1 Preset	10 bytes (mm/deg)
Axis 1 Function 0 = ref, 1 = incr, 2 = abs, 3 = zero inc	1 byte
Axis 1 Ref. Step #	3 bytes integer
Axis 1 RoundOff 0-9, a-f table index (below)	1 byte

TURNVISION™

Axis 1 FlashPoint	10 bytes real (mm/deg)
Axis 2 Name 0 = null, 1 = z, 2 = z1, 3 = z2, 4 = y	1 byte
Axis 2 Preset	10 bytes real (mm/deg)
Axis 2 Function 0 = ref, 1 = incr, 2 = abs, 3 = zero inc	1 byte
Axis 2 Ref. Step #	3 bytes integer
Axis 2 RoundOff 0-9, a-f table index (above)	1 byte
Axis 2 FlashPoint	10 bytes real (mm/deg)
FeedRate	10 bytes integer
Speed (rpm)	10 bytes integer
Tool #	2 bytes integer
Reserved Must be 0	1 byte
AutoStep flag 0 = no, 1 = yes	1 byte
end of line <cr>	1 byte

TOTAL 77 bytes

Round Off Table

Table #	Associated Value	
0	1.0	mm/deg
1	0.5	mm/deg
2	0.2	mm/deg
3	0.1	mm/deg
4	0.05	mm/deg
5	0.02	mm/deg
6	0.01	mm/deg
7	0.005	mm/deg
8	0.002	mm/deg
9	0.001	mm/deg
a	0.0005	mm/deg
b	0.0002	mm/deg
c	0.0001	mm/deg
d	0.00005	mm/deg
e	0.00002	mm/deg
f	0.00001	mm/deg

Figure OP12. Round Off Table.

There are seven communication commands that are used when performing transfers between TURNVISION and the remote storage device.

- A. IDENTIFICATION COMMAND
- B. DIRECTORY COMMAND
- C. AVAILABLE SPACE COMMAND
- D. GET RECORD (0) of FILE (INDEX#) COMMAND
- E. GET RECORDS (ALL) of FILE (INDEX #) COMMAND
- F. SEND RECORDS (ALL) of NEWFILE (NAME) COMMAND
- G. DELETE FILE COMMAND

Communication commands

During program transfers, between TURNVISION and a remote storage device, TURNVISION is always the **issuer** of commands and the remote storage device is always the **respondent**. A written program will have to interpret the command and issue a response, for a transfer function to work correctly.

Note: For each command, enter the information *within the quotes* — do not enter the quotes. Commands and responses are followed by a carriage return (<cr>), which signifies the end of a transmission.

A. Identification command

The identification command contains the TURNVISION ID information. This command is used to confirm and initialize or reset the communications link between TURNVISION and the remote storage device. The RESPONSE must follow within four seconds or a "timeout" will occur, and the remote device will not be available.

COMMAND "AAT6<cr>"

Definition: "AA" is the command type
"T" is TURNVISION
"6" is release number of the firmware

RESPONSE "AAab<cr>"

Definition: "AA" is the response type
"a" is either "I" for IBM-PC, or "B" for Stand-Alone Box
"b" release number of soft/firmware

B. Directory command

The remote storage device is responsible for determining the amount of disk space available and the number of files (programs) in the disk directory. The remote storage device also maintains an alphanumeric list of available program file names and sizes. A numeric INDEX is used to identify a file in a list, where the first file has an index of 01, the second is 02, etc. With this type of index, all necessary file information can be determined without the operator having to supply its name.

The directory command issued by TURNVISION, contains the INDEX of the ITEM in the directory being requested. The RESPONSE returns the FILENAME and FILESIZE from the directory.

COMMAND "BBaa<cr>"

Definition: "BB" is the command type
"aa" is the INDEX of the file requested. The INDEX is 2 character ASCII numeric unsigned integer, right justified field with left zero suppression to spaces (except units position).

TURNVISION™

Communication commands (cont.)

RESPONSE: "BBabbbbbbbb.bbb ccccccc<cr>"

Definition: "BB" is the response type
"a" is the RESPONSE FLAG (see list below)
"bbbbbbbb.bbb" is the name of the file from the directory. The FILENAME is 8 + 3 ALPHA/NUMERIC characters with a POINT separating the EXTENSION from the NAME, and a trailing space for separation from the next field (filesize).
"cccccc" is the filesize from the directory. The FILESIZE is 8 character ASCII numeric unsigned integer, with left zero suppression to spaces (except units position).

Possible Response Flags:

"0" GOOD, function complete
"1" BAD, INDEX parameter (out of range) (not numeric)
"2" BAD, MEDIA write lockout
"5" BAD, MEDIA read error/verify
"6" File not found
"7" BAD, disk not ready

C. Available space command

This command orders TURNVISION to determine if there is enough space for a particular program to fit on the remote storage device directory.

COMMAND "CC<cr>"

Definition: "CC" is the command type

RESPONSE "CCabbcccccc<cr>"

Definition: "CC" is the response type
"a" is the RESPONSE FLAG (see list below)
"bb" is the number of FILE ENTRIES AVAILABLE in the remote storage device directory. FILE ENTRIES AVAILABLE is a 2 character ASCII numeric unsigned integer, with left zero suppression to spaces (except units position). 25 file entries maximum per directory.
"cccccc" is the bytes available from the directory. BYTES AVAILABLE is an 8 character ASCII numeric unsigned integer, with left zero suppression to spaces (except units position.).

Possible Response Flags:

"0" GOOD, function complete
"2" BAD, MEDIA write lockout
"5" BAD, MEDIA read error/verify
"7" BAD, disk not ready

TURNVISION™

Communication Commands (cont.)

D. Get record (0) of file (index #) command

This command is used to retrieve the "General Identification header" which contains the remote program, number of steps, etc. for use with the LOAD operation.

COMMAND "DDaa<cr>"

Definition: "DD" is the command type
"aa" is the INDEX of the file requested. The INDEX is a 2 character ASCII numeric unsigned integer, right justified field with left zero suppression to spaces (except units position).

RESPONSE "DDaDATA<cr>bb<cr>"

Definition: "DD" is the response type
"a" is the RESPONSE FLAG (see list below)
"DATA<cr>" is the contents of the FIRST line/record of data from the file, terminated by <cr>, end of string.
"bb" is the CHECKSUM value generated by the data.

The checksum is calculated by adding all the DATA bytes (including the trailing <cr>), to an unsigned binary value which is converted to two ASCII-HEX characters and sent, the checksum bytes are followed by a <cr> that terminates the RESPONSE.

Possible Response Flags:

"0" GOOD, function complete
"1" BAD, INDEX parameter (out of range)
"5" BAD, MEDIA read error/verify
"6" BAD, file not found
"7" BAD, disk not ready

E. Get records (all) of file (index #) command

This command is used to send the entire file to TURNVISION from the remote storage device. Hardware or software handshaking is required, unless the baud rate is very low.

COMMAND "EEaa<cr>"

Definition: "EE" is the command type
"aa" is the INDEX of the file requested. The INDEX is two character ASCII numeric unsigned integer, right justified field with left zero suppression to spaces (except units position).

RESPONSE "EEaDATA<cr>bbDATA<cr>bb<cr>"

The basic transmission unit is "DATA<cr>bb", sequence (above), repeated twice.

TURNVISION™

Communication Commands (cont.)

Definition: "EE" is the response type
"a" is the RESPONSE FLAG, see list.
"DATA<cr>" is the contents of one line/record of data from the file, terminated by <cr>, end of string. Approximately 80 data bytes can be expected, but it is not fixed. 1 to 250 bytes are possible.
"bb" is the CHECKSUM value generated for the data. The checksum is calculated by adding all the DATA bytes (including the trailing <cr>), to an unsigned binary accumulator, and performing a modulo 256 to obtain an 8 bit value. This value is converted to two ASCII-HEX characters and sent. The last checksum byte is followed by a <cr> that terminates the RESPONSE.

Possible Response Flags:

"0" GOOD, function complete
"1" BAD, INDEX parameter (out of range)
"2" BAD, MEDIA read error/verify
"5" BAD, file not found
"7" BAD, disk not ready

F. Send records (all) of newfile (name) command

This command sends the entire file from TURNVISION to the remote storage device. Hardware or software handshaking is necessary, unless the baud rate is low. The response to the command returns the new file (INDEX #) after re-sorting the directory.

COMMAND "FFaaaaaaaa<cr>DATA<cr>bbDATA<cr>b-
bDATA<cr>bbDATA<cr>bb<cr>"

The basic transmission unit is the "DATA<cr>bb" sequence (above) repeated four times.

Definition: "FF" is the command type
"aaaaaaaa<cr>" is the name of the file to save, *without* the DOS extension.
"DATA<cr>" is the contents of continuous lines/records of data from the file, terminated by <cr>, end of string.
"bb" is the CHECKSUM value generated for the data. The checksum is calculated by adding all the DATA bytes (including the trailing <cr>), to an unsigned binary accumulator, and performing a modulo 256 to obtain an 8 bit value. This value is converted to two ASCII-HEX characters and sent. The last checksum byte is followed by a <cr> that terminates the COMMAND. The end of the file is recognized by noting that the last <cr> had no data before it.

RESPONSE "FFabb<cr>"

Definition: "FF" is the response type
"a" is the RESPONSE FLAG (see list below)
"bb" is the INDEX of the stored file. The INDEX is a two character ASCII numeric unsigned integer, right justified field with left zero suppression to spaces (except units position).

Possible Response Flags:

"0" GOOD, function complete
"1" BAD, INDEX parameter (out of range)
"2" BAD, MEDIA write lockout
"3" BAD, MEDIA insufficient space
"4" BAD, CHECKSUM
"5" BAD, MEDIA read error/verify
"7" BAD, disk not ready

G. Delete file command

This command deletes files by the FILENAME

COMMAND "GGaaaaaaaa.aaa<cr>"

Definition: "GG" is the command type
"aaaaaaaa.aaa" is the name of the file from the directory. The FILENAME is eight plus three ALPHA/NUMERIC characters with a decimal point separating the NAME from the EXTENSION.

RESPONSE "GGa<cr>"

Definition: "GG" is the response type
"a" is the RESPONSE FLAG (see list below)

Possible Response Flags:

"0" GOOD, function complete
"2" BAD, MEDIA write lockout
"5" BAD, MEDIA read error/verify
"6" BAD, file not found
"7" BAD, disk not ready

TURNVISION™

Connector Specifications

Footswitch

1/8 inch (3.5mm) phono jack

Edge Finder

1/8 inch (3.5mm) phono jack

Centronics Parallel Printer

Female 16-pin SDL connector:

pin	1 - strobe (active low)	(out)
	2 - data 1	(out)
	3 - data 2	(out)
	4 - data 3	(out)
	5 - data 4	(out)
	6 - data 5	(out)
	7 - data 6	(out)
	8 - data 7	(out)
	9 - data 8	(out)
	10 - acknowledge (active low)	(in)
	11 - busy	(in)
	12 - paper empty	(in)
	13 - select	(in)
	14 - auto feed	(out)
	15 - N.C.	
	16 - GND	

External Video Monitor

Female phone jack

RS-232 Communications

Male 9-pin D-subminiature connector

Pin	I/O	Description
2	I	Incoming Data
3	O	Out going data
4	O	When active (logical "0", + 12V), it informs the other device that TURNVISION is available to communicate.
5		Signal ground
6	I	When active (logic "0", + 12V), it indicates that the other device is available to communicate.
7	O	When active (logical "0", + 12V), it indicates that TURNVISION is ready to receive data.
8	I	When active (logical "0", + 12V), it indicates the device is available to receive data.

NOTE: THE TURNVISION CHASSIS COVER SHOULD NEVER BE REMOVED FROM THE UNIT — THERE IS NOTHING WITHIN THE CHASSIS THAT CAN BE FIELD SERVICED.

TURNVISION is equipped with an electrically powered exhaust fan for the dissipation of internally generated heat, and features a passive, filtered, fresh air intake. Adequate airflow to the intake should be allowed for, as well as accessibility to replace the filter assembly, if necessary.

If TURNVISION's internal temperature rises above a preset limit, a message will appear on the screen (when in the DRO mode). This message will direct the operator to select the HELP screen for remedial action.

WARNING - Whatever the reason for the diagnostic filter message, it is imperative that the unit be shut down and the fault rectified as soon as possible (the immediate machining operation may be completed).

"Check Filter" Faults and Remedies

- 1) **Inadequate airflow to the filtered intake** - Make sure paper, wipes, or debris are not restricting air circulation around and under the unit.
- 2) **Plugged Filter** - The fan filter is easily removed for cleaning or replacement. Simply unsnap the protective outer guard from the main fan assembly. Clean the filter with soap & water (let dry before reinstalling). Replacement filters are available from ACU-RITE Factory Service (1-800-632-3222).
- 3) **Work area temperature too high** - TURNVISION is designed to function in a temperature range of 5° to 40° C (41° to 104° F) with 25-85% relative humidity, non condensing. If the work area temperature is too high, it is recommended that TURNVISION be shut down until temperatures return to the normal operating range.
- 4) **Exhaust fan does not operate at high temperatures** - The exhaust fan only runs when internal temperatures are high. If the "Check Filter" warning is present, indicating high internal temperatures, and the fan is not turning do not continue to operate TURNVISION. Excessive internal temperatures can damage the electronic components. Contact your ACU-RITE Distributor/OEM or the *Factory Service Department* (1-800-632-3222) for repair or replacement information. for repair or replacement information.

Unit Line Fuse

If there is power to TURNVISION, but it does not power up, check the line fuse on the back of the chassis. If the fuse is bad, replace it with an equivalent 1.5 AMP 250V, 1¼" length fuse.

Troubleshooting

Ventilation system

TURNVISION fuses

TURNVISION™

Troubleshooting software errors

Hardware Identification

CPU Module number and Axis Module numbers can be found as follows:

- 1) Press the SET SYS mode key.
- 2) Press the "MISCELLANEOUS" menu key.
- 3) Press the "TESTS" menu key.
- 4) Press the "HARDWARE IDENTIFICATION" menu key.

The screen will display the CPU Module and Axis Module numbers. These numbers will be useful if discussing a problem with the ACU-RITE Service Department.

If a problem arises within TURNVISION, error messages and help to recover from the error appear on the screen.

Possible errors in data transmission from one module to another and encoder performance include:

ERR T1 - Module (axis) transmitting invalid data

ERR T2 - CPU Module transmitting invalid data

ERR T3 - Previously identified module fails to communicate

ERR T4 - Invalid data request

ERR C1 - Invalid pulse counting

ERR C2 - Encoder output signal is out of spec

ERR C3 - Invalid encoder input signal, for those axes with differential input option

"T" Errors are self-correcting (up to a certain level). The system will attempt to remedy the condition several times before prompting the operator.

ERR T1 and ERR T2 trap errors from partial communication hardware breakdowns and from certain communication software errors. If a bit gets dropped during a data transfer, or if an axis board fails to recognize a data request code, the error message results.

ERR T3 appears if the module is removed while the unit is operating or if there is a communication hardware failure. This error will also appear if the software fails to interface with the communication hardware.

"C" Errors involve the axis board encoder pulse circuitry and software. These errors are *not* self-correcting and must be remedied by the operator (through an error recovery routine) or an ACU-RITE serviceman.

ERR C1 is a software error "trap". It occurs if the axis board microprocessor is unable to access the pulse counting circuitry (keeping current encoder position), or if the circuitry fails to count correctly. This error may be corrected by resetting the axis board in question. It should, however, be interpreted as a serious error and the axis board serviced or replaced.

ERR C2 is a hardware error generated by the axis board encoder input circuitry. This electronic circuit constantly monitors the integrity of the encoder signal for slew speeds greater than the unit can accommodate. Incorrect pulse train sequence or electro-magnetic interference (noise) will make the unit count incorrectly. These problems are outside the readout and require the operator to first correct the external problem and then reset the axis board.

Error messages note the error type, the slot location of the deviant module, and the particular axis the error has occurred.

Most error codes can be reset by restarting the axis board in question. This is done through the "ERROR RECOVERY" menu key which becomes active in the DRO display once an error has occurred.

Press the "ERROR RECOVERY" menu key to restart an axis board. A screen indicating the axis board and encoder connection in error, possible reasons the error occurred, steps to recover from the error, and requirements are displayed.

Press the "FIX AXIS" menu key to restart the axis in question. A note will appear indicating if the error was removed successfully or unsuccessfully. If the error was removed successfully, the axis board is reset and the problem is no longer present. If the error was *not* removed successfully, the problem is still present and further troubleshooting must continue. The problem may be a faulty module or in the linear encoders.

Note: If a home reference point is used (FTO or Absolute Zero scales), "C" type errors require that it be found again.

If a hardware fault is suspected (axis board, CPU board or power supply board), please contact your ACU-RITE distributor for further information.

ACU-RITE products and accessories are under a one-year (from date of purchase) warranty for defects in material and workmanship. ACU-RITE will, at its option and expense, repair or replace any parts of the ACU-RITE Product which fail to meet this warranty. However, ACU-RITE must have received notice of the claimed defect from the consumer during the warranty period.

This warranty applies only to products and accessories which have been installed and operated in accordance with instructions in ACU-RITE reference manuals. ACU-RITE shall have no obligation, with respect to any defect or other condition, caused in whole or part by the consumer's incorrect use; improper maintenance or modification of the equipment, or by the repair or maintenance of such product by any person except persons deemed by ACU-RITE to be qualified.

Loss in operating performance due to environmental conditions, such as humidity, dust, corrosive chemicals, deposition of oil or other foreign matter, spillage or other conditions beyond ACU-RITE's control cannot be accepted by ACU-RITE.

Resetting error codes

Warranty

TURNVISION™

There are no other warranties expressed or implied, and ACU-RITE INCORPORATED shall not be liable under any circumstances for consequential damages.

Before returning the unit to your local ACU-RITE Distributor or Original Equipment Manufacturer, be sure that all efforts to correct a problem have been exhausted.

Specifications

Dimensions	14" W x 14.5" D x 7.5" H
Weight	Approximately 25 lbs.
Power Input Requirements	95-130, 180-250 VAC, 1.5 amp, 57-63
Number of Display Axes	1, 2, 3, or 4 (user configurable)
Electronics	Multiple Microprocessor
Display	7" diagonal CRT
Scale Resolutions	Standard resolutions (user specified) 10 μm (.0005") 5 μm (.00025") 2 μm (.0001") 1 μm (.00005")
Linear and Rotary Encoder Input	Channel A & B TTL Square Wave signal in quadrature (90) nominal phase relationship with Fiducial Trigger Output signal (when provided)
UL & CSA Compliance	Pending

FCC Compliance Statement for USA Users

This equipment uses, generates, and can radiate, radio frequency energy. If this product is not installed and used in accordance with the operator's manual, interference to radio communications may result. This product has been tested and is in compliance with the limits in effect at the time of manufacture for a Class A computing device pursuant to Subpart J of Part 15 FCC Rules. These limits provide reasonable protection against such interference when operated in a commercial environment. Operation of this equipment in a residential area may cause interference, in which case the user will be required to take whatever measures necessary to correct the interference at the user's expense.

Glossary

ABSOLUTE - The measurement of total distance moved along an axis from a fixed datum point (zero, zero reference or workpiece zero) on, or fixed with reference to, the workpiece.

AUTO STEP - An optional feature in the PROG mode which combines the current program step with the next step and displays both at the same time. This feature allows the operator to view up to 4 axes at one time (the axes must be 4 different axes).

BATTERY BACKUP - One of two self-contained DC auxiliary power sources. One power source is a standard feature that maintains axis parameters and programs if AC power is interrupted or lost.

CRT - Acronym for Cathode Ray Tube; main viewing screen of the unit.

CPU (CENTRAL PROCESSING UNIT) - The integrated circuit which provides control of memory and computational functions.

CHECKSUM VALUE - A summation of bits or digits. Primarily used for checking ROM (Read Only Memory) computer memory to ensure it has not been altered.

COMPOUND REST - The portion of the lathe carriage which holds the toolholder assembly. The compound rest can be rotated and moved in a linear manner.

CURSOR - The movable "pointer" which indicates where entries or actions will take place.

DIRECTION POLARITY - The assignment of a + or - value to a direction of motion along an axis. This assignment is based on shop standards or operator's choice.

DMS - Degrees, Minutes, Seconds. One form of displaying angularity. The other form is decimal degrees (DEG).

FIDUCIAL TRIGGER OUTPUT (FTO) - A pulse generated when a fiducial (reference) mark on a glass scale is sensed by the scale reading head. The FTO signal is used to relocate workpiece zero after a power interruption and it is used to define the interval locations when using Multiple Error Compensation.

FREEZE - To hold an axis display with its current value, not allowing it to be changed by incoming scale information.

INCREMENTAL - A measurement indicating a distance from the current tool position to a desired tool position (point to point). Incremental moves comprise the absolute measurement (parts make up the whole).

MICROPROCESSOR - The control and processing portion of a small computer.

MULTIPLE SCALE COUPLING (MSC) - The capability within the readout of mathematically combining the signals from two parallel linear encoders. The screen will indicate the coupled axes and display the combined resultant motion of the two scales.

TURNVISION™

MULTIPLIER - A parameter in a program that can be used to alter axis displays using shrinkage or expansion factors for mold or die work, or when machining a part to scale. A multiplier of -1 can be used to machine mirror images.

RAM - Acronym for Random Access Memory. This memory holds information and programs during processing "temporary" memory.

REFERENCE PRESET - Sets the incremental display to the distance and direction required to move to a desired position which is referenced from the axis absolute zero point.

RESOLUTION - The smallest (or least count) unit of motion that a readout system is capable of measuring and displaying.

ROM - Acronym for Read-Only Memory. A storage arrangement for information retrieval only. This memory contains operational instructions ("permanent" memory).

RS-232C - A type of serial communication. When this capability is supplied with the readout, it allows communications in both directions, between the readout and computer or other peripheral device.

SOFTWARE - Programs, routines, codes, and other written information which communicate commands to a computer.

TACTILE - A type of key, that when pressed, can be felt to "snap". The snap indicates to the user that the input was accepted.

TAPER - The gradual reduction in the diameter of a cylindrical part along an axis.

THAW - The menu key which will cancel a frozen display. See FREEZE.

TOOL OFFSET - Values generated from tool dimension information to correct the display when tool changes are made. Tool offsets alter the readout display to indicate the true position of tool cutting surfaces.

TTL - Acronym for Transistor-Transistor Logic. Family of logic circuit designs found within digital electronics.

VECTORIZING - Trigonometric routine which separates a movement into two component movements which are at right angles (90 degrees) to each other.

Standard Linear encoder specifications

REPEATABILITY	Within one resolution count
OPERATING CONDITIONS	0°C to 50°C (32°F to 122°F) 25% to 95% relative humidity (non-condensing)
STORAGE CONDITIONS	-40°C to 65°C (-40°F to 149°F) 20% to 95% relative humidity (non-condensing)

ELECTRICAL CHARACTERISTICS

- TTL compatible transistor collector output with internal pull-up resistor.
- Logic "1" level:
pull-up to Vcc ($5.1 \pm .1$ Vdc through a resistor,
pull-up resistor = $450 \pm 10\%$ ohms)
- Logic "0" level:
0.5 Vdc maximum
-7ma maximum (current sinking limit)
- Required Input Connector:
Bendix PTO 6A-10-6P or equivalent

STANDARD CABLE CONNECTOR

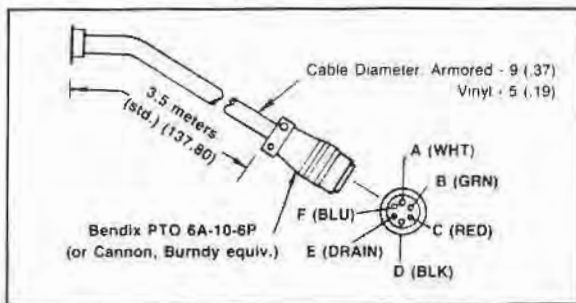

PIN A
Channel A
(Typical)



PIN B
Channel B
(Typical)

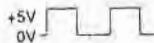

PIN F
Fiducial
Trigger
Output
Typical

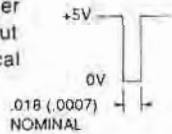

PIN INPUT/OUTPUT

A	Channel "A" square wave signal
B	Channel "B" square wave signal in quadrature (90° nominal phase relationship) with channel "A" signal
C	Vcc, +5.1 ± .1 Vdc, current, 200mA max
D	Common (power supply and signal return)
E	Shield, reading head case ground
F	Fiducial trigger output signal (when provided)

TURNVISION™



**ACU-RITE Readout Systems
are manufactured in the USA**

ACU-RITE®

ONE PRECISION WAY
MASON INDUSTRIAL PARK
JAMESTOWN, NEW YORK 14701
(800) 344-2311

